

Royal Borough of Kensington and Chelsea Residential Basement Study Report March 2013



Alan Baxter

Alan Baxter

Prepared by Michael Coombs

Reviewed by Jim Gardiner

Issued December 2012

Re-issued March 2013

T:\0954\0954-130\DTP Data\Indesign Docs\0954-130_Royal Borough of
Kensington and Chelsea_Residential Basement Study Report_2013-03.indd

This report has been prepared for the Royal Borough of Kensington and Chelsea and is valid only at the time of its production. This report should not be copied or relied upon by third parties for any purpose whatsoever.

Alan Baxter & Associates LLP is a Limited Liability Partnership registered in England, number OC328839. Registered office 75 Cowcross Street, London, EC1M 6EL.

© **Royal Borough of Kensington and Chelsea 2013**

Royal Borough of Kensington and Chelsea Residential Basement Study Report March 2013

Contents

1.0 Introduction	1
2.0 The Purpose of the Report	4
2.1 The 2008 Scoping Study	4
2.2 The 2012 Report (This Report)	6
3.0 The Historical Development of Kensington and Chelsea.....	7
4.0 Topography.....	8
5.0 Geology.....	9
6.0 Groundwater.....	11
7.0 Residential Properties in Kensington and Chelsea	12
8.0 Classification of Basements Projects	13
9.0 Structural and Civil Engineering Considerations	16
9.1 General	16
9.2 Engineering techniques for forming residential basements in urban areas	17
9.3 Ground Movements.....	22
9.4 Groundwater Issues	24
9.5 Flooding.....	27
9.6 Water Ingress	29
9.7 Landscaping and Trees.....	30
9.8 Site Coverage by basements built outside the footprint of a house	31
9.9 Adjoining Ownerships	33

10.0 The Party Wall Etc Act 1996, in relation to Basement Design and Construction	34
11.0 Sustainability Issues	37
12.0 Construction Issues	39
13.0 Recommendations for Basement Design and Construction	42
13.1 Relevance	42
13.2 General	42
13.3 Specific Recommendations	43
14.0 Work to be done and/or submitted when a planning application is made for the construction of a basement in a residential building in RBKC.....	46
14.1 Actions by the Applicant.....	46
14.2 Preplanning Work – Desk Study and Site Investigation.....	46
14.3 Engineering Design Work.....	47
14.4 Engineering Design and Construction Statement (EDCS)	48
14.5 Construction and Demolition Management Plan (CDMP) and Construction Traffic Management Plan (CTMP)	50
14.6 Sustainability Statement.....	50
14.7 Landscaping and Planting Statement.....	50
14.8 Drawings to be provided (minimum requirement).....	51
15.0 References.....	52
Appendix A	54
Figures	54
Appendix B.....	82
Questions and Answers.....	82
Appendix C	87
Brief Case Studies.....	87
Appendix D.....	95
The Historical Development of Kensington and Chelsea.....	95
References.....	98

1.0 Introduction

- 1.1 The constraints of building in Central London are such that there is little opportunity to extend residential properties higher or laterally. These factors have led to the increasing trend to construct basements below gardens or beneath existing residential buildings to create both habitable and ancillary space. RBKC has seen a year on year increase in basement developments as a result.
- 1.2 The construction cost of basement space is at least twice as high as above ground construction. This makes it uneconomic in lower value areas of London. However in high value areas, these construction costs are usually well below the value of the space that is created or the overall increase in value of the property that they generate. RBKC contains the highest average residential property in the UK. This lies behind the increasing number of planning applications for the construction of basements in the Borough.
- 1.3 Traditional buildings rest lightly on the ground and, when removed, leave little significant disturbance for future generations. However in the last decades development in construction and engineering allow us to create much greater depths of construction not just for civil engineering projects but for even domestic buildings. Basements of more than one storey in depth create a permanent irreversible change in the ground conditions. This permanent and irreversible disturbance increases rapidly with the depth. Successful cities need to control and plan their long term development with the knowledge of what is of significance below ground level and what changes below ground mean in the long term.
- 1.4 Planning policy in the UK has generally evolved and developed on the basis of above ground construction with policy designed to deal with issues such as visual impact, character, views and public space. In addition, considerations such as overlooking and sunlight/daylight are key, especially with regard to the effect of proposed development on adjoining ownerships & tenancies. There is no planning policy evolution in respect of basement construction and until recently, basement applications were considered on an individual ad-hoc basis. RBKC has had a policy in the Unitary Development Plan for many years, which, slightly modified, was incorporated into the Core Strategy, The increase of basement construction projects led to the need for more comprehensive guidance, and to that end a Supplementary Planning Document (SPD) was adopted in 2009. As the trend in relation to the construction of basements continues, it is appropriate to review the policy both in the Core Strategy and in the SPD.

- 1.5 The construction of basements beneath or close to existing buildings is often technically very challenging and demanding. This is frequently not appreciated or understood by the building owners (freeholders or leaseholders) who commission these projects. In fact it is extraordinary that these works on properties worth several million pounds are sometimes entrusted to teams without the know-how and understanding of the technical issues involved. “Specialist” contractors have jumped on the basement bandwagon. Some are very capable and experienced, whereas others are not. The technical demands involved in the design and construction of these projects varies. A team that has successfully completed a relatively straightforward basement construction project may not be appropriate to tackle a much more complex project. There is a problem in that lay clients do not have the knowledge and experience to tell how complex their proposed project is and to judge whether or not the team they appoint has the ability and experience to handle the work.
- 1.6 Adjoining owners and residents in RBKC have raised concerns about basement construction. These concerns relate to the protection of their own properties from damage caused by adjacent basement construction, the disruptive effect of the construction process when a basement is built, the potential for basements to cause changes to the ground water regime in an area and consequential flooding, and the long term change to the character of the area (particularly the front and rear gardens).
- 1.7 Existing Party Wall legislation and common law are considered by government to be sufficient to deal with relationships and disputes between adjoining owners. When the Party Wall legislation was drawn up it did not specifically consider the addition of basements beneath or close to adjoining buildings. The legislation is specifically aimed at maintaining the party walls between adjoining owners and controlling how development on each side of a party wall is arranged, so as to preserve the status and integrity of the Party Wall. It also deals with neighbouring construction close to work in the ground as is described in Section 10. Party Wall surveyors are therefore limited in what they are able to require of adjoining owners who wish to build basements. They have to interpret the Party Wall Legislation in situations which were not contemplated when it was drawn up.
- 1.8 The common law works when problems arise and usually first requires there to be a dispute. When and if things reach this stage, the remedies, which may be to seek injunctive relief or damages, are expensive and often unsatisfactory. Some property owners in RBKC do not have the financial means or know-how to employ such remedies. This can be a cause of a great deal of anxiety and concern.

- 1.9 Health and Safety legislation is also arguably a factor in that it imposes duties on designers and contractors to work in ways that do not endanger construction workers or the public. The CDM Regulations¹, which also impose duties on the client (building owner or developer) do not apply to domestic owner - occupied projects. This is understandable where most domestic developments in the UK are straightforward, but the regulations should arguably apply to all building owners and developers, where complex works are to be carried out. The CDM regulations are currently under review and this aspect may be reconsidered as part of that review. However, Health and Safety legislation deals only with people and not with property, so it cannot be relied on to protect adjoining owners' property interests.
- 1.10 Planning policy is unable to resolve all of the issues but it is able to control development, when it is of a scale that requires planning permission, and encourage applicants who wish to carry out works to their properties or sites, to do so in ways that mitigate impacts on and difficulties for residents, adjacent owners and the public in general. It is incumbent on the applicant to clearly demonstrate feasibility and provide details of how they intend the work to be done and what the implications of that work will be, when submitting a planning application.
- The issues that need to be considered as part of the planning process are described at the end of this report.
- 1.11 This report uses the words 'basement' and 'subterranean' interchangeably.

¹ The Construction Design and Management Regulations 2007 which impose duties on Clients, designers and contractors to consider health and safety at all stages of a project from inception through to completion and thereafter in use.

2.0 The Purpose of the Report

2.1 The 2008 Scoping Study

2.1.1 In 2008, The Royal Borough of Kensington & Chelsea commissioned a Scoping Study which aimed to identify and assess the likely importance of factors and issues considered as being potentially relevant to policies on subterranean developments in the Borough.

2.1.2 In December 2010 the Council adopted its Core Strategy. This included a number of policies that are specific to the consideration of new basement development.

2.1.2.1 Part (g) of Policy CL2, "New Buildings, Extensions and Modifications to Existing Buildings"

The Council will require it is demonstrated that subterranean extensions meet the following criteria:

- i. the proposal does not involve excavation underneath a listed building
- ii. the stability of the existing or neighbouring buildings is safeguarded
- iii. there is no loss of trees, townscape or amenity value
- iv. adequate soil depth and material is provided to ensure sustainable growth

2.1.2.2 Part (c) of Policy CE1, "Climate Change"

The Council will require an assessment to demonstrate that the entire dwelling where subterranean extensions are proposed meets EcoHomes Very Good (at design and post construction) with 40% of the credits achieved under the Energy, Water and Materials sections, or comparable when BREEAM for refurbishment is published

2.1.2.3 Part (a) of Policy CE2, "Flooding"

The Council will resist vulnerable development, including self-contained basement dwellings, in Flood Risk Zone 3 as defined in the Strategic Flood Risk Assessment

2.1.2.4 Other policies within the Core Strategy are relevant, in particular, Policy CL2, "New Buildings, Extensions and Modifications to Existing Buildings", in so far as it relates to extensions

“The Council will require new buildings, extensions and modifications to existing buildings to be of the highest architectural and urban design quality, taking opportunities to improve the quality and character of buildings and the area and the way it functions”.

2.1.2.5 Policy CL3, “Heritage Assets – Conservation Areas and Historic Spaces”

The Council will require development to preserve and to take opportunities to enhance the character or appearance of conservation areas, historic places, spaces and townscapes and their settings.

2.1.2.6 These policies are complemented by the Council’s Subterranean Development Supplementary Planning Guidance (2009). Whilst this predates the Core Strategy policies, it remains relevant.

2.1.3 The scoping study was carried out by Arup Geotechnics in June 2008. It concluded the following:

- a) Subterranean development cannot be viewed in isolation from other planning issues and several of the Borough’s planning policies that exist, impinge upon subterranean development even though not specifically designed to do so.
- b) Assuming that Policy CD32 of the UDP (2002) which deals explicitly with subterranean development in the Borough is carried forward into the new Core Strategy, Policy CD32(c) which deals with structural stability of buildings in conservation areas, should be considered for application to all buildings in the Borough.
- c) The impact of basement development on groundwater levels and groundwater flows will be site specific but that in general the effect of a new basement on groundwater levels will be relatively small (equivalent to seasonal variation), though they need to be considered on their merits.
- d) The public consultation revealed significant concerns about the potential for structural damage from subterranean development. Subterranean development is significantly more challenging in engineering terms than most other forms of development. The risks of damage are high when basement works are ill-planned, poorly conceived or badly implemented. However many challenging subterranean developments have been successfully completed, generally undertaken by experienced competent teams.
- e) Consideration should be given to encouraging clients of subterranean development projects to ensure that the teams they engage for such projects are competent and experienced and that they are engaged from an early stage and retained throughout the course of the project, with a brief that encompasses the full spectrum of activities.

- f) There is a difference between subterranean developments in buildings that share a party wall with their neighbours (or two party walls) and those that are detached. The former involve greater technical engineering challenges over and above the concerns about noise, vibration and general disturbance.
- g) Buildings with shared party walls founded on clay involve greater technical engineering challenges than those founded on gravel, particularly in relation to the longer term effects. Consideration should be given to requiring specific additional pre-planning considerations by clients when basements are proposed in clay subsoil areas.
- h) Any spatially-variant policies related to the near surface soil type need to recognise that geological mapping is approximate and that boundaries indicated on the maps may not be accurate.

2.2 The 2012 Report (This Report)

- 2.2.1 The main purpose of this report (The 2012 Report) is to assist RBKC to review and develop their planning policy in relation to subterranean development in the Borough, building on the work of the 2008 Scoping Study and the feedback from the public consultation in 2012. It will form a foundation for the review of basement (subterranean) policy in both the Core Strategy and SPD.
- 2.2.2 This report is also intended to clearly set out the issues and factors that need to be understood and considered by all interested parties when a basement is proposed for construction in residential areas of the Borough. It is intended to encourage clients who wish to undertake such development to understand why it is necessary to carefully select an appropriate team to deal with technically demanding construction. It informs adjoining owners and the public as to what the possible implications of such development might be with guidance on the procedures that the client wishing to construct the basement should follow as good or best practice. It provides information for Officers and Members of the Council which is intended to assist them to deal with concerns and questions from their residents.
- 2.2.3 Issues that were not highlighted in the conclusions of the Scoping Study but which are further considered in this report are:
 - a) the effect of subterranean development on the gardens, landscaped areas and trees within the Borough and the overall character and nature of the green space.
 - b) sustainability considerations and energy use.

3.0

The Historical Development of Kensington and Chelsea

- 3.1 Kensington and Chelsea was first settled in Anglo Saxon times with separate settlements existing for many centuries before they were gradually absorbed by London from the late 17th century.
- 3.2 The layout and character of the Borough as we now know it dates from the 18th century in Chelsea and the southern part of the Borough. The north of the Borough dates largely from the 19th century.
- 3.3 Most of the development was houses until the late 19th century when flats started to be built in the form of mansion blocks.
- 3.4 Urbanisation of the Borough reached a peak at the end of the 19th century, shortly before the start of the First World War.
- 3.5 The far north of the Borough (north Notting Hill and Kensal Green) had developed with a much poorer quality housing stock than the areas to the south. It also contained industrial sites of potteries and sites for refuse collection. This area has seen significant changes since the Second World War due to slum clearances and redevelopment of the industrial and waste sites.
- 3.6 The historical development of the Borough is illustrated in the maps in figs 1 to 5.
- 3.7 A more detailed account of the Historical Development of the Borough is given in Appendix D.

4.0 Topography

- 4.1 The Royal Borough of Kensington and Chelsea is bounded to the west by the historic water course Counters Creek which is now culverted and to the south by the Thames between Cremone Wharf to the west and Chelsea Bridge to the east. The eastern boundary south of Knightsbridge generally follows the course of the River Westbourne which flows from the Serpentine into the Thames. (Fig 6)
- 4.2 The area north of the Thames up to Kensington High Street and Olympia is low lying within the extended Thames Basin. Here the topography is generally flat. This level ground extends northwards along the route of Counters Creek up to White City and Latimer Road. The land rises from these river basins at the northern end of the Borough. Just north of Holland Park there is steeply rising ground leading up to Notting Hill, a local high point which dominates the topography of the Borough. There are a number of lost rivers (historic water courses) which flowed east-west across the area, draining into the Counters Creek and the River Westbourne. These no longer exist but will have affected the geology of the area locally and may influence groundwater conditions. There are a number of man-made features which are now imposed on the topography including the West Way and West Cross-Route to the north east of the borough and the railway infrastructure built in the 19th century.

5.0 Geology

- 5.1 The geology of London and the Thames Basin lies above a deep concave layer of chalk which outcrops to the north as the Chilterns and to the south as the North Downs. The material within the chalk basin comprises Thanet Sands at depth overlain by the Lambeth Beds (formerly known as the Woolwich and Reading Beds) which are generally a mixture of sand and clay. Above this is London Clay which in Kensington & Chelsea is approximately 50m deep generally and which outcrops at the surface around Notting Hill and north of it. (Figs 7 and 8)
- 5.2 Above the London Clay there are deposits of sands and gravels which can be up to 10m thick. These were deposited over the last ice age. At that time the route of the River Thames assumed to its current location. The process of eroding its valley has created a series of sand and gravel terraces. Each of these are named by the area where they are best known. While each of these have slightly different characteristics which impact on their geotechnical properties, they can all generally be classified as sands and gravels.
- 5.3 In places there are deposits of Langley Silt (sometimes called brickearth) which is a mixture of silts, clays and sands. These formed the basic material for London stock bricks. Typically this overlies the sands and gravels. Because of its use for making bricks, Langley Silt has been excavated in many areas and the resulting pits backfilled generally with poor quality material. Also, in some locations the sands and gravels may also have been excavated for use in construction.
- 5.4 On top of these natural deposits there is often a layer of fill or made ground which results from hundreds of years of human occupation. In parts of Central London this can be 4 to 6m thick. However, other than in localised areas, RBKC has only been built on for the last 150 years, so there is less fill, typically no more than 1 to 2m.
- 5.5 As part of the initial development of an area and in many parts of RBKC, houses were developed with a raised ground floor level and a lower ground floor which provided access to the rear garden. As a general guide the garden level is likely to relate relatively closely to the pre-development ground levels in the area, with the road levels raised between one and two metres above this. Excavated material from foundations, drain runs etc was used to build up the general level of the roads. Vaults were constructed under the pavements originally for the storage of coal.

- 5.6 In the Notting Hill area the Boyn Hill Gravel and Lynch Hill Gravel overlay the London Clay while there is Langley Silt over the Clay to the west of Notting Hill in the Counters Creek basin. Most of the southern part of the Borough is covered by Kempton Park or Taplow Gravel which can be up to 10m thick. Locally these may be overlain with Langley Silt.
- 5.7 The areas close to the Thames, the Westbourne and Counters Creek have more recent alluvial deposits at or close to the surface.
- 5.8 Although there is a pattern to the geology and ground conditions of the Borough with London Clay close to the surface to the north of the Borough, gravels close to the surface at the south with some alluvial deposits along the edges of the Thames and Counters Creek, there are local variations and these can be fairly significant when designing and constructing basements. They need to be fully understood. This can only be done by careful desk study, supplemented by site investigation works.

6.0 Groundwater

- 6.1 The London basin contains an aquifer which lies deep below ground within the Thanet Sands and Chalk. It is fed from the chalk outcrops to the north and south of the Thames Valley. However, because of the impermeable London Clay which lies beneath the gravel terraces there is a local perched water table which is fed by precipitation within the Thames Valley. This is known as London's Upper Aquifer. A significant contributor to the water in the upper aquifer is burst or leaking water mains. The water on this upper aquifer tends to flow slowly across the surface of the London Clay depending on the permeability of the overlying sands and gravels. London's development has altered what were natural open ditches which flowed into tributaries of the River Thames; Counters Creek and the River Westbourne. However the upper aquifer water levels do not vary significantly as water drains away into the Thames basin.
- 6.2 The flows across the surface of the London Clay have historically eroded shallow channels in the surface of the clay which tend to be filled with sand and gravel. These can have an influence on local ground water levels and ground water flows.
- 6.3 The combination of the topography and geology around Notting Hill is particularly unusual and in places causes unusually high ground water flows which can be problematic for subterranean construction, unless this is recognised and clearly understood by those designing and constructing basements.

7.0 Residential Properties in Kensington and Chelsea

- 7.1 The Borough contains the full variety of residential properties from terraces of small houses to large single properties and a variety of Mansion Blocks. Many of the larger terraced or semi-detached houses were converted to flats in the 50s, 60s and 70s. More recently there is a tendency to convert some of these back to single dwellings particularly in the highest value areas.
- 7.2 The tenure of properties is a significant factor in where new basements are likely to be procured. Buildings with multiple leaseholds create legal issues which mean that the addition of a basement is less likely, though not impossible. Residential conversions in the 19th century buildings with a generous unit on the lower levels and a shared freehold are more likely to be the subject of a subterranean development proposal than for example a mansion block or purpose built apartments. Structural considerations make the latter much more complex and problematic, as well as leasehold and freeholder issues.
- 7.3 Single owner occupancy terraced, semi-detached or detached properties are those where the addition of basements is most likely to be encountered. Many of these are relatively large compared with most London residential properties. They were built traditionally with masonry external walls and party walls where they are joined to their neighbours. These masonry walls tend to have simple corbelled brick foundations sitting on the natural ground, usually gravel or London Clay. Some late 19th century buildings of this type may have mass concrete strip foundations as generally found in 20th century single residential buildings. There are internal load bearing walls which may be timber stud or brick filled stud on upper levels but are almost always masonry on the lower level with similar foundations to the external or party walls. The floors of these buildings are generally timber with the lower floor either timber on sleeper walls or a concrete groundbearing slab.
- 7.4 The overall quality of construction varied, even in similar looking houses and, as today, depended on the attitude and skill of the original builder and money. Later interventions can add yet more variables.

8.0

Classification of Basements Projects

- 8.1 When contemplating basement construction on a site of an existing residential building, it is important that the overall situation is considered so that feasibility is judged not simply on a spatial brief, but also on the basis of adjoining ownership, planning policy and technical feasibility, taking account of the constraints that will influence the planning, design and construction of the proposed project.
- 8.2 When the work is to be done to a semi-detached or terraced property, adjoining ownership issues are governed by party wall legislation. This legislation sets out how the parties on each side of a party wall should proceed when one of them is proposing works that affect the party wall or the adjoining property. This is discussed in more detail in section 10.
- 8.3 Planning Policy is developed by local authorities within the framework of national planning legislation. Traditionally these policies were developed to control above ground development, but have equally been applied to below ground development. However, there is now an awareness that different factors apply to planning policy for below ground development.
- 8.4 The subsoil below existing buildings performs a variety of functions. It provides a founding material for buildings; it supports streets and infrastructure; it contains utilities and services; it supports plant growth and biodiversity; and it acts as a drainage medium. It is clear that the effect of below ground construction on these functions must be considered at the planning stage and that planning policy needs to evolve to control underground development, so that these functions of the subsoil are not fundamentally altered, damaged or destroyed by such development.
- 8.5 From the work on the characterisation of the Borough, it can be seen that there are a number of key factors that determine how complex basement proposals are. These factors influence their feasibility in legal, planning policy and technical terms.
- 8.6 The main issues that need to be considered are:
- a) *The configuration of the existing property and its neighbours*

This involves considerations about the layout and structural form of the building and adjoining development, whether it has an original basement or not, and the history of alteration of the building.
 - b) *The geology and ground conditions*

Is the property founded on fill, gravel or clay and what are the geological and topographical factors that need to be considered?

c) *The groundwater regime in the area and at the site*

The upper aquifer and groundwater generally need to be understood as they apply to the property in question. Are there any local subsurface water channels in the clay at or close to the site?

d) *Land drainage of the site, the immediate area surrounding the site and the wider area.*

How does the area, within which the site is located, drain? Does the site lie within any of the Borough's surface water flood hazard zones? How does the upper aquifer drain?

e) *Topographical considerations and unusual influences*

Is the site within the Notting Hill area, subject to particularly unusual groundwater flows because of the influence of the topography and geology? Is the site located close to old or existing water courses and what could be the implications of this?

f) *Major infrastructure and services (Underground railways, sewers, utilities etc)*

Development teams for all subterranean development sites need to consider whether or not they are close to or above major existing or planned infrastructure and whether such infrastructure will be affected by the proposals.

g) *The location of the new basement*

i) Under the house

ii) Under the garden

iii) Both

h) *The depth of the proposed new basement*

This is very significant factor in determining how complex and disruptive the design and construction of a new basement will be. As a general rule single levels of basements (but not all) are relatively straightforward to build. Multiple basement levels are very much more challenging and complex.

i) *The building type*

i) Terraced house

ii) End of terraced or semi detached house

iii) Detached villa/house

- j) *The foundation details of the existing property, particularly for terraced or semi-detached houses which share a party wall with their neighbours*

Where the existing building foundations are shallow and on clay, the excavation of a basement can be much more problematic for an adjoining owner in terms of the effects of movement on their property, than for situations where buildings are founded in gravel well above the London Clay. In such cases particular care needs to be taken to address this issue

- k) *The condition of the existing building and its neighbours.*

This not only involves an understanding of the construction and structural arrangement, but of the history of any ground movements within the buildings and to buildings in the nearby area. Are the movements historic? What caused them? Are they ongoing and why?

- 8.7 It is important to recognise that each case must be considered on its merits and that each needs careful consideration by experienced construction professionals. They should carry out a desk top study, research the local area and carry out on-site inspections to be able to advise fully on all of these issues at an early stage.

9.0 Structural and Civil Engineering Considerations

9.1 General

- 9.1.1 When inserting a basement under or close to an existing building and alongside adjoining buildings or structures, there is always a very close relationship and interaction between the design and construction.
- 9.1.2 Unlike most above ground structures, where temporary works tend to be independent of the permanent structure (e.g. access scaffold, formwork, falsework or temporary shoring to boundary walls), parts of the permanent works are often used as temporary works to achieve the new underground volumes. This means that the designer and constructor need to collaborate closely to understand how their work influences and relates to that of the other party. Underpinning and contiguous or secant piled walls are examples of elements of construction which have to perform both permanent and temporary works functions. Often the permanent works can only partly perform the temporary works function and have to be supplemented by temporary propping or strutting.
- 9.1.3 In most situations the design and construction are technically demanding and should not be underestimated. Problems generally do not arise when the design and construction are thoroughly and fully considered and the interaction between design and construction is properly explored and taken into account. Things tend to go wrong when basement design and/or construction is undertaken by those who do not have the ability or expertise required, or where there is inadequate interaction between design and construction. As noted earlier, building owners are often not in a position to judge the level of competence and ability required for their project. Many procure the design and construction on price alone, without understanding or checking whether those they entrust the design and construction to actually have the ability and expertise to do the work.
- 9.1.4 Designing and constructing a basement beneath or close to an existing building the following engineering issues need to be considered.
- a) How to resist earth and water pressures on the new basement walls and floor
 - b) How to deal with groundwater and potential water ingress
 - c) How to support existing structure above and adjacent to the new basement construction
 - d) Drainage

- e) Ground movements and how these affect the existing structures above and adjacent to the new basement construction both in the short and long term.
- f) Whether or not the proposals are likely to alter groundwater levels or groundwater flows.
- g) How the construction will effect landscaping and in particular trees in the short and longer term.

9.1.5 The above apply for both the temporary and the permanent works and need to be fully addressed in relation to the short and long term.

9.2 Engineering techniques for forming residential basements in urban areas

9.2.1 The approach that needs to be taken to the engineering design and construction of basement extensions depends on a number of factors. The most significant of these are:

- a) Whether the basement is under the existing house, under the garden outside the footprint of the main house or a combination of the two conditions.
- b) The depth of the basement.
- c) The ground conditions.
- d) The ground water conditions.

9.2.2 Basements under the footprint of the existing house

9.2.2.1 For single basements, underpinning is the most common form of engineering construction to extend the foundations of the existing building down to below the level of the proposed new basement floor. Generally foundations have to be lowered by around 3m to 4m. This usually involves two stages of underpinning construction to avoid dangerous, deep excavations. (Fig 9)

9.2.2.2 An exception to this is when forming single basements under terraced or semi-detached houses founded in clay subsoil where there is a history of movement, particularly if it is ongoing (see 9.2.5).

9.2.2.3 Piled walls should be considered where deeper basements are to be built (excavations of greater than 3 or 4m), where the excavations have to extend below the perched water table (Upper Aquifer) or where a basement is proposed in or adjacent to a building which is part of a terrace (or is a semi-detached property) with a history and evidence of ongoing movement and founded on London Clay or fill material. These walls are generally set inboard

of the party walls and away from the main loadbearing external walls of a building. (Fig 10)

9.2.3 Underpinning

9.2.3.1 Underpinning through London Clay is relatively straightforward, as there is usually no groundwater. Most, but not all, excavations in London Clay remain stable in the short term, but shoring will be required in all excavations to provide safe access. (Fig 11)

9.2.3.2 Underpinning through sands and gravels above the perched water table is relatively straightforward. The excavated faces require temporary shoring and extra attention is needed if the sands and gravels are loose.

9.2.3.3 Where there is a perched water table in the sand and gravel the underpinning should ideally stop approximately 300mm above the water level. If excavation has to continue below this level, then measures must be taken to control the ground water. Water ingress in an excavation can wash the fines out of the gravel causing the sides of the excavation to collapse. If the material is predominately sandy, the situation is much more challenging, as the sand can easily be washed out by the ground water. Apart from safety issues, this can lead to settlement of the surrounding area. Options available include local dewatering and permeation chemical grouting. Injection of cement based grout is unreliable in these situations and is not effective in controlling ground water inflows.

9.2.3.4 Underpinning is a challenging construction technique that needs considerable thought. It involves the temporary removal of support to the construction above in sequential stages and relies on the construction above each section of underpinning to be able to span or bridge over each excavated section while the underpins are constructed. The configuration of the structure above the foundation level is a very significant consideration which needs to be fully understood if underpinning is being proposed. Large openings at the base of walls, buried services, poor quality construction of existing walls and poor ground conditions can all be problematic and if not considered and understood, these issues can lead to problems or even collapse of structures being underpinned.

9.2.3.5 The integrity of the construction immediately above each section of underpinning is critical for the safety of the construction workers carrying out the underpinning. In cases where the masonry is not well bonded, contains voids or has lost its integrity propping may be needed. In some cases, underpinning may not be possible.

9.2.3.6 It is generally not possible to underpin isolated piers using conventional underpinning techniques. Heavily loaded piers are particularly problematic.

9.2.3.7 When underpinning operations go wrong, resulting in movements, cracking of masonry or collapse of the construction above, it is often because the issues

mentioned above in 9.2.3.4 to 9.2.3.6 have not been studied, understood and taken into account by the designers and constructors of the underpinning.

9.2.3.8 Traditional underpinning is usually designed to support vertical loads. Lateral earth pressures must also be considered. One approach to this is to adopt reinforced underpins with enlarged bases. If the wall to be underpinned is a Party Wall, these are denoted as special foundations under the Party Wall Etc Act 1996. They are not favoured, as the foundations to the Party Wall are not equally shared by both sides and there may be long term implications for both of the adjoining ownerships. (Fig 12)

9.2.3.9 The normal approach, which most Party Wall Surveyors require is the construction of a reinforced concrete box within the perimeter of the underpinning, which is designed to resist all permanent and long term lateral loads and to provide support for the internal structure. Until this structure is complete, the underpinning has to be propped (as the excavation proceeds) to resist the temporary lateral earth pressures. This approach of building a reinforced concrete box within the underpinned walls also helps with detailing of the basement waterproofing. (Fig 13)

9.2.4 Piled Walls

9.2.4.1 A contiguous piled wall is one where piles are constructed at close centres, but where there is a small gap between each pile which can easily be bridged by the ground. The construction of such walls requires a low headroom rig to work within the footprint of an existing building. This solution reduces the basement areas available and so is only really suitable for larger residential properties. It is likely that there may still be a requirement for shallow underpinning of the perimeter walls along the line of the piled walls to facilitate the construction of the capping beam on top of the piled wall. (Fig 14)

9.2.4.2 Once the piles are constructed, the basement is formed by excavating within the perimeter of the piled wall. Most piled walls need to be propped during this stage of construction to resist the lateral earth pressures on them from the retained earth and adjoining construction and to limit movement of the surrounding ground. The stiffness and arrangement of propping is critical and is often not well considered, especially as this propping is a nuisance to the contractor, because it obstructs the site and complicates the construction. Some contractors do not understand the relationship between stiffness of these propped walls and ground movements. (Fig 15)

9.2.4.3 Contiguous piled walls need to be faced up with sprayed or cast concrete walls to fully support the ground on the retained earth side of the basement in the permanent condition.

9.2.4.4 Where groundwater is present, secant piled walls are normally used. These are similar to contiguous walls but, as their name suggests, they are a continuous line of intersecting piles that provide a barrier to groundwater.

They are more specialist than contiguous piles. There are a variety of arrangements but typically, every other pile is constructed as a “soft” pile using a bentonite concrete mix, so that the subsequent hard piles which are reinforced concrete to carry the vertical and horizontal loads, can be drilled through them, intersecting the pair of “soft” piles on each side as each is constructed. Once the piled wall is built, the construction can progress as for a contiguous piled wall, but care is required, as breaches in the wall are possible due to construction tolerances of piles. These may allow water ingress locally that will need to be dealt with as soon as it is discovered.

9.2.5 Basements under terraced or semi-detached houses founded in clay which have a history of ground movement

- 9.2.5.1 Some buildings with shallow foundations in London Clay or fill material have and continue to experience ground movements, generally as a result of seasonal or climate-related changes in moisture content of the clay in the immediate vicinity of their foundations. The effects of trees on the moisture content of the clay can also be a cause of this movement.
- 9.2.5.2 Most of these buildings were built in the 19th century using weak bricks set in lime mortar and are generally able to cope well with minor movements, because the lime mortar can accommodate them without visible cracking. Internally cracks tend to be minor and distributed. Terraced properties move as a whole and semi-detached properties move together, because they have similar foundations. They are effectively single structures.
- 9.2.5.3 In structures such as this, underpinning one building in a terrace, or one of a pair of semi-detached properties, will extend its foundations and those of the party wall down to a depth where the clay is stable and where there is no seasonal variation to cause ground movements. The consequence of this can be to create new problems which are experienced by an adjoining building, because of differential movements between the structure that has not been underpinned and the one that has. These problems will be more significant than those experienced prior to the construction of the underpinning and will be ongoing into the future. They will be significant if there is a history of movement in the buildings and particularly if that movement is current. (Fig 16) In cases where terraces or semi-detached properties founded on London Clay do not have a history of movement or exhibit ongoing movements then the problem is less likely to arise but needs to be considered nevertheless.
- 9.2.5.4 It is essential when considering the construction of a basement under a terraced or semi-detached property founded on London Clay, that these issues are carefully considered, understood and addressed. Basements can be formed without underpinning and in cases where there are ground movements of adjoining properties founded on clay, other techniques such as piled walls may be more appropriate and preferable.

9.2.6 Basements under gardens or open space

9.2.6.1 In densely developed urban areas such as RBKC, piled walls are usually used when forming basements in rear gardens or on land without any construction above it. Contiguous or secant piled walls can be used but there are other methods available, particularly where there are no groundwater problems present.

9.2.6.2 It is beneficial for the existing adjoining buildings if these basements are designed and built so that they are structurally independent of the structures of the adjoining houses.

9.2.6.3 Sheet piled walls

Sheet piles can either be driven in to the ground or jacked in. Driving sheet piles is noisy and causes vibrations, so is not suitable for the construction of basements in residential areas. Jacking can be adopted, but requires relatively large construction equipment. Jacking piles through gravels can be difficult and sometimes impossible if the gravel is dense. Water jetting in conjunction with jacking can be used, but this is not suitable for the construction of basements in residential areas, close to other buildings. Another approach is to excavate a trench and slot the sheet piles in. This approach is not generally possible, as it leaves the face of the trench unsupported in the short term and the ground will have to move to fill the inevitable voids, unless the voids are grouted up.

9.2.6.4 King Post Walls

These are a practical alternative to piled walls for single level basements. They usually require less space than a piled wall but a piling rig is needed to install the king posts. However, they are less suitable for deeper basements or where excavations extend below the water table. Ground movements are generally greater than for underpinning or contiguous/secant walls and they cannot be readily used close to existing buildings.

9.2.7 Basements that are both under a house and garden

9.2.7.1 The principles set out in 9.2.2 and 9.2.6 above apply generally, but thought is needed as to how the basement walls are constructed where they cross the line of the rear (or front) wall of the property. It is not possible to construct a continuous secant piled wall across the interface so, if ground water is present, some other method of resisting the ground water inflows at the gap in the wall needs to be found. Permeation grouting is one possibility.

9.2.7.2 Additional temporary works are likely to be required to deal with pressures and ground movements at these locations until the permanent works have been completed.

9.2.7.3 It is preferable, when constructing a basement that extends both under an existing building and the rear (or front) garden, to arrange the design and construction such that there is a joint between the sections of basement under the footprint of the house and that below the garden. This will influence the spatial design of the basement (Fig 17). It is very important, when designing such basements, to give full consideration to the proper support of the walls of the house, account for differential movement between the house section and garden basement and consider the effect of the design proposals on the adjoining buildings and boundary walls. It is difficult to achieve a joint when the basement is below the water table.

9.3 Ground Movements

- 9.3.1 Excavating in the ground causes it to move. This is because the forces within the subsoil which are maintaining its equilibrium are disturbed by removal of material. The ground moves as it seeks a new state of equilibrium. Where a building or other construction is supported on ground that is disturbed or affected by excavations, it will also move and can suffer damage as a result. Minor movements generally do not cause structural damage. They may not be noticeable or result in just superficial damage to finishes.
- 9.3.2 This is not a new phenomenon. Whenever a site in dense urban area is redeveloped or a building is extended, excavations for the new construction cause local, usually small ground movements which need to be considered. What is relatively new is the excavation for new construction below existing buildings or for new subterranean development close to existing construction. It is important that these works are designed and executed in ways which limit movements such that structural damage to the existing buildings is avoided.
- 9.3.3 Generally construction techniques have been developed that seek to maintain the equilibrium in the ground when excavations take place. It is not possible to fully maintain the state of equilibrium, but by adopting methods of construction which provide continuous or near continuous support to the ground, with propping (both temporary and permanent) designed to control movements, the effects of subterranean development can be mitigated and controlled. Movements, when major works are carried out, occur both in the short term as well as over a longer period (of a year or more) as the structures settle down.
- 9.3.4 Things have gone badly wrong in situations where these issues have not been fully considered, understood or implemented, either because proposals have been too ambitious or because incorrect techniques and procedures have been followed. It is important that the various causes of potential movement are understood and considered when planning the construction of a basement beneath or next to an existing building.

9.3.5 Settlements caused by underpinning and piling

9.3.5.1 The process of underpinning a wall inevitably leads to a degree of settlement of that wall. The amount of settlement depends on a wide variety of issues, such as ground conditions, the depth of underpinning, presence of ground water, the condition of the wall being underpinned, the extent of shoring provided and the quality of workmanship. Small uniform settlements of a building do not generally cause distress, but when differential settlement occurs, this may result in cracking.

9.3.5.2 If feasible, the whole structure should be underpinned. When this is not practical, transition pins can be provided to reduce the effect of a sudden change in founding level. However, this is not feasible where one owner is forming a basement next to an adjoining building with no basement. There will be steps in founding levels between adjacent walls of adjoining buildings. This can be significant for terraced or semi-detached houses founded on fill or in London Clay which exhibit a history of movement (see 9.2.5).

9.3.5.4 The process of installing a bored pile wall or a king post wall also causes a degree of settlement of adjacent structures, as the lateral support to the soils beside the piled wall is removed temporarily during its construction.

9.3.6 Ground heave caused by excavation within an underpinned perimeter

9.3.6.1 Following the installation of the underpinning either a “top-down” or “bottom up” method of construction is used for the basement excavation. (Fig 18)

9.3.6.2 A top-down construction forms the ground level slab first which provides lateral support to the top of the walls. It is then under-dug to form the basement. A bottom up construction adopts a system of temporary props while excavation is carried out and the new basement constructed in a conventional manner.

9.3.6.3 Either solution is acceptable and the choice is usually site specific. Most basements built in residential buildings are bottom up, unless they are unusually large or deep. Generally bottom up causes slightly greater ground movements to occur.

9.3.6.4 As the excavation progresses, the loading on the underlying soil reduces and it expands or heaves. Some of this happens immediately. In London Clay part of the heave can occur over many years. In sands and gravels there are no long term effects and the short term effects tend to be small. Clay underlying sand and gravel will heave even if it is below the level of the new basement floor.

9.3.6.5 The overall heave which can occur for a single level basement is generally not a significant issue but for two storey or deeper basements, ground heave needs to be carefully considered by the designers.

9.3.7 Ground movements associated with ground heave and the excavation of a basement within an underpinned or piled wall

- 9.3.7.1 When a basement is excavated the change in stress in the ground, particularly at the bottom of the excavation, results in a general migration of the ground surrounding the excavation, towards it. The inward movement of the retaining structures (walls) even if they are well propped, cannot be completely avoided and this adds to the movements. (Fig 19) Overall, if properly designed and built, these effects are usually small, but they need to be considered for the structure above the excavation and for adjoining buildings, whether they are attached as part of a terrace or detached but adjacent structures. Initially the ground at the surface adjacent to the excavation will settle and move horizontally towards the excavation. The movements are greatest near the excavation (though the vertical movements are less immediately at the wall because of restraint). (Fig 20) In time heave can be an issue causing small upward ground movements in some cases. It is the differential movements (the difference in movement between different parts of a building) that matter, especially for the adjoining buildings. Most 19th century buildings can cope with small differential vertical and horizontal movement without suffering structural damage.
- 9.3.7.2 Each case needs to be considered on its merits. Houses with fine stone stairs need careful consideration, as cantilevering stone stairs are much less tolerant to movement than walls built in lime mortar. Similar considerations apply when there are tiled or marble floor finishes.
- 9.3.7.3 In most cases, well designed and carefully constructed residential basements can be achieved without causing structural damage to adjoining buildings. (For the classification of structural damage see section 10.8). It is not always possible to avoid minor damage to finishes, which can be dealt with by local making good and redecoration. Most situations involving structural damage associated with residential basement construction, have arisen because of a lack of correct configuration or adequate support to retaining structures and excavations.
- 9.3.7.4 The aim of all clients who embark on basement schemes for their properties should be to procure the works so that they do not cause structural damage to their own property but more importantly to their neighbours properties, and also to services, utilities and any major infrastructure (for example railways and sewers) close to these sites.

9.4 Groundwater Issues

- 9.4.1 RBKC has all the typical surface geological conditions found in central London. Each of these has different implications for groundwater.
- 9.4.2 The underlying material is London Clay which, for the purposes of this report, can be considered to be impervious. Where there are over-lying layers of sands and gravels, there is usually water at the top of the London Clay, known

as a perched water table, or the Upper Aquifer. Where there is a slope at the interface between the London Clay and the overlying gravel this water can “flow”. (Fig 21) However any flow in the ground water tends to be fairly small. Typically there is a general fall in the ground levels and the levels of the top of the London Clay from north to south towards the Thames. Around Notting Hill, where the topography is steeper and the ground conditions are more complex, groundwater issues can be significant and need much more care. (see Fig 8) There are also two significant historic water courses, Counters Creek and the River Westbourne and there can be a localised ground water flows towards them.

- 9.4.3 Another consideration relates to houses which are close to the Thames, which is tidal. The river wall is not impervious to flows of water. There is a limited flow through the wall at each tide and this can impact on basements within the affected zone. This only applies to properties close to the river.
- 9.4.4 The London Clay is underlain by the Lambeth Beds, Thanet Sands and then Chalk. There is a lower aquifer within the Thanet Sands and Chalk at considerable depth below existing ground level at RBKC. Historically this water has been extracted, usually for industrial purposes. The water level in this aquifer fell in the 19th century as a result of this extraction. The rate of extraction of this water has decreased over the last few decades, so the water level in the lower aquifer has been rising. The level of this ground water is carefully monitored as, if it was not controlled, it could start to impact on some of the deep tunnels which contain London’s critical infrastructure. It has very little relevance for domestic basement projects. It is this Lower Aquifer which is frequently referred to in reports which state that groundwater levels in London are rising. The water levels in the Upper Aquifer are not rising or changing. There are normal seasonal variations that are rainfall related.
- 9.4.5 Where the surface geology is London Clay, there is generally no upper aquifer present and no groundwater flow. Water falling on gardens or parks tends to be retained in the topsoil or upper clay layers until it evaporates or is absorbed by vegetation. Some finds its way into drains connected to the sewers.
- 9.4.6 Basements constructed in clay effectively form a hole in the clay which can fill up with water and which is not able to drain away naturally. Although the hole appears to be completely filled in by the new basement structure which displaces water, the hydrostatic water pressures in the basement are present because of water at the interface between the clay and the basement construction up to the top of the clay or slightly higher than this depending on the ground conditions above the clay. This issue needs to be carefully considered in the design. The structure needs to be designed to resist the hydrostatic pressure unless something is done to relieve it. Flotation can also be an issue, particularly for basements in clay subsoil beneath rear gardens or internal basements with little load on top of them.

- 9.4.7 Excavations in gravel or sand, which are wholly above the perched water table of the Upper Aquifer, should not impact on any groundwater issues unless the form of construction extends down close to or below the aquifer and creates a cut off to the water. If there was a groundwater flow, it can continue in the ground below the level of the new basement.
- 9.4.8 Basements which extend through the gravels below the water table into the underlying London Clay should be considered in more detail. While an individual basement is unlikely to cause any significant change in water levels, long term group effects need to be considered. Checks should be carried out on the levels of the London Clay to establish if the water may flow. If a flow is expected, then clearly identified routes should be explored, together with any potential impacts on surrounding buildings.
- 9.4.9 A long terrace of houses with a significant number of basements through gravel into clay can act as a barrier to the flow of ground water and can change the groundwater regime in an area. If an assessment of the cumulative effect of basements in a terrace shows this to be a possible problem, such changes can be addressed in the design of a basement, by providing drainage or engineered flow arrangements below or around the proposed basement.
- 9.4.10 Basements which are close to historic water courses require even more detailed checks. The two principal water courses, The Westbourne and Counters Creek are both now culverted and used as sewers. The alignment of the sewers generally follows the original route but not always. Underground water flow is more likely along the historical route. Any proposed basements in these areas need careful checking.
- 9.4.11 In areas where there are existing houses with basements or lower ground floors and where the existing perched water level is close to the lowest occupied area, a new basement needs very careful consideration. The construction of a new basement could slightly increase groundwater levels “upstream” and on either side of the basement, locally raising the level of the perched water. In certain locations this could cause previously dry basements to become damp or wet. (Fig 22) This can be addressed by the design of the new basement (see 14.4.1d).
- 9.4.12 There are a number of different names for the gravel beds which relate to the geological process when they were deposited. The area around Notting Hill has a series of terraced gravels with outcrops in London Clay. The perched water in the upper gravel terraces can flow out at the interface with the London Clay causing ground water flooding. Also the surface of the London Clay is not uniform and there are channels in the London Clay which are filled with gravels. Basement proposals in the area around Notting Hill need very careful consideration as the ground water regime is likely to be more unpredictable and complex.

- 9.4.13 In rare situations where significant groundwater flows exist or where a basement could cause the local raising of the perched groundwater level, which could be significant for adjacent existing construction, measures should be included in the design to equalise the water pressure and levels across the new construction.

9.5 Flooding

9.5.1 Flooding from the Thames

- 9.5.1.1 The River Thames is protected against a 1:1000 year fluvial flood event by a combination of the river wall and the Thames flood barrier. The critical situation for flooding from the Thames is a combination of prolonged heavy rain in the Thames Valley in conjunction with a storm surge in the North Sea, leading to extremely high tides. The effects of climate change are increasing the risk of flooding and will need to be addressed further in a future flood defence strategy for London.
- 9.5.1.2 Parts of RBKC close to the River Thames are at risk from overtopping of the river walls in a significant flood event if there was a failure of the Thames Barrier. If a more severe flood occurred, the Thames Barrier itself could overtop and be unable to defend London against the flood. Generally the Thames Barrier is operated to control the river levels in tidal flood conditions so that they do not exceed the height of the river walls in London. The areas of RBKC that are at risk of such flooding are indicated in Fig 23. While statistically this combination of events is a very low probability, the consequences of inundation are extremely serious, so all thresholds to new basements in these areas (i.e. the unprotected access points above the enclosing walls and roof slabs) should where possible be set to prevent water ingress in the event of an overtopping incident, particularly if they accommodate living accommodation.
- 9.5.1.3 Another event which also needs to be considered is a breach of the river wall i.e. a localised failure of the wall during a high tide. In the event of this occurring, water could flow onto the flood plain behind the wall for several hours before the tide drops. The areas which are affected are very similar to the areas noted in 9.5.1.2 (Fig 24). Again the thresholds of new basements should be set to prevent water ingress, ensuring that both access and egress will be safe where there is a breach incident. Where such levels cannot be achieved flood management plans can be considered as an alternative approach. These need to deal with safe exit from basements in the event of flooding (amongst other things).

9.5.2 Surface Water Flooding

- 9.5.2.1 During periods of very heavy rain, rainwater is sometimes unable to soak sufficiently into the ground, partly because of the large areas of impermeable

paving and roof and because the ground may already be saturated. When this occurs, the only route for the stormwater to escape is via the drains and sewers. Any area of the country can experience localised flooding as a result of short duration, very intensive rainfall, but the worst case scenarios are when the sewers and drains become ineffective in such storms. Road gullies and drains in hard landscaped areas may have insufficient capacity to drain the area, or drains can become surcharged. In such cases water tends to build up locally and flow along roads. At low points or where there are obstructions, significant local flooding can occur, so basements in these areas may be at risk of flooding.

- 9.5.2.2 RBKC have commissioned various studies (refer to Draft Surface Water Management Plan) which provide an indication of the estimated surface water depth and surface water flood hazard rating. These are based on surface water modelling and have been co-ordinated with historic flood records. The maps relate to several events, from a 1:30 to a 1:200 return period rainfall event. These maps give a general indication of flooding in an area but are not specific to any property. They give a reasonable indication of above ground flow paths for this surface flood water and areas where surface water flooding might occur in local depressions. (Fig 25) The Council is currently reviewing their Strategic Flood Risk Assessment (SFRA) and draft Surface Water Management Plans (SWMP). This review is expected to be completed in the spring of 2013.
- 9.5.2.3 Clients who wish to build basements in areas which have a risk of surface water flooding should consider the issue and take steps to protect their basements against water ingress as a result of this flooding.

9.5.3 Flooding from Sewers

- 9.5.3.1 London's sewage and stormwater drainage system is, mostly, a combined one, with the same drains being used to carry foul and stormwater. The system was designed and installed in the 19th century with local sewers flowing into a main west-to-east interceptor sewers built by Joseph Bazalgette.
- 9.5.3.2 The steady state foul water flows are low and the sewers depend on higher flows from rainfall conditions to cleanse them. During periods of prolonged high rainfall or short duration very intense storms, the main sewers are unable to cope with the storm flows.
- 9.5.3.3 The interceptor sewers overflow directly into the Thames but in order to do so, they back up and the water levels in them rise. This causes backing up of some local sewers and a loss of drainage capacity. The consequence of this is that during periods of intense rainfall, some roads and paved areas can flood. As RBKC is located at the lower end of the sewer catchment there have been several instances of the sewer system backing up and flooding properties. Basements and lower ground floors of buildings which are directly connected

to such sewers are at risk of flooding with sewage in these conditions, normally through sinks and toilets.

9.5.4 Groundwater Flooding

9.5.4.1 There is a perched water table within the sands and gravels which overly the London Clay. This is constantly topped up by rain (and burst or leaking water mains). Where this water table meets the surface, groundwater or springs can appear. There are a few isolated records of where this has occurred. These are shown in the draft Surface Water Management Plan.

9.5.4.2 Groundwater flooding is most likely to impact on basements where the basement floor level is close to the existing groundwater levels.

9.5.5 Combination of Effects

9.5.5.1 Flooding of local areas or basements is usually caused by a combination of events (surface water, groundwater and sewers). Within RBKC there are areas which are considered as having critical drainage problems. These areas will be formally defined following a review of the Strategic Flood Risk Assessment and Surface Water Management Plan. This review is expected to be completed in the spring of 2013.

Fig 26 shows the recorded flooding incidents within RBKC.

9.5.5.2 Basements planned in these areas will need to be designed to take account of these increased flood risks. To do this, those designing and building new basements need a thorough understanding of the flood risks and conditions.

9.6 Water Ingress

9.6.1 Modern basements should be designed to provide a dry and habitable space. The methods used will depend on the construction techniques and the experience of the designers and contractors. The two most common techniques are to either “tank” the basement by using a membrane on the outside to keep moisture or water out, or to provide a drained cavity inside the basement structure, which assumes that there may be some water ingress and provides a drainage system to collect the water and pump it away. Where a drained cavity is used, the primary basement structure should be designed to keep out major flows of water within the ground. The pumping should only deal with minor water inflows.

9.6.2 The principal sources for water ingress are as noted above:

- groundwater
- surcharging of sewers
- surface water flooding

- 9.6.3 Apart from rainfall, groundwater levels can be raised significantly due to leaking water mains. Good engineering practice generally assumes that basements should be designed on the assumption that there is an external water level at least up to 1m below ground level. The definition of ground level is an engineering decision, as it may be different for different parts of the basement. Alternatively, the highest credible water level should be considered.
- 9.6.4 Burst or leaking water mains are surprisingly common, and whilst these are usually short term events, they can have a substantial impact by causing significant local raising of groundwater levels.
- 9.6.5 During periods of heavy and prolonged rain, the existing drains in an area may be prevented from discharging and in extreme events water will flow back through the system coming out of manholes and gullies. Basement areas are most at risk. There are a variety of one way (non-return) valves which can be installed to prevent or reduce this risk. The valves need regular maintenance. However, depending on levels, falls etc the existing gullies may not be able to drain away when the non-return valves are closed. Water flowing into the local drainage system of the property will back up and can cause flooding as a result.
- 9.6.6 A more fool-proof system is to totally separate out all the drainage from the basement and use a pumped system with appropriately designed storage for all below-ground level of drainage. This arrangement has also long term maintenance requirements. At present there are a significant number of basements in the Counters Creek area which regularly experience flooding due to the drains being surcharged. Thames Water are undertaking flooding local improvement projects (FLIP) at a number of properties that are the worst affected. These are essentially non-return valves with pumps and a storage chamber In parallel they are looking at major investments in the drainage infrastructure (in particular the Counters Creek Sewer Alleviation Scheme) to increase capacity of the sewer system, and the provision of Sustainable Urban Drainage Systems (SuDS) to reduce the amount of water entering the sewer system..

9.7 Landscaping and Trees

- 9.7.1 Trees within a neighbour's garden but close to a boundary could be affected by a new basement. All trees within conservation areas and other trees with Tree Preservation Orders (TPO's) are protected and so must be considered when designing a new basement. British Standard 5837, 2012 (Trees in relation to design, demolition and construction) suggests that basements should not be constructed within a distance of twelve times the diameter of the trunk of a tree.
- 9.7.2 It may be acceptable for a basement to be partially under the canopy of a tree but the method of construction adopted should not damage the tree and this needs careful consideration at the planning stage.

9.7.3 Tree protection details should be considered with the input of an arboriculturist and no excavation arisings should be placed over the tree roots. The final ground level in the tree protection zone should be kept as close to existing as is feasible and the permeability of the ground should not be changed, so as not to alter the status quo.

9.7.4 Basements which extend under trees or Root Protection Areas² at any depth should not be permitted even though it may be possible to demonstrate that it is technically feasible.

9.7.5 It is RBKC's policy that all new basements under gardens should have a minimum 1m of soil over the slab, (plus the insulation and waterproofing layers) to allow for the cultivation of normal gardens above them. There are sound engineering principles related to surface water management and the maintenance of the groundwater on a site and in a local area that support this policy (see 9.8.5) Consideration must be given to water retention within the soil to support planting but with adequate drainage to ensure that the ground does not become waterlogged.

9.7.6 The retention of gardens and the growth of trees is important in order to retain the character of the Borough and to maintain and promote biodiversity. In addition to requiring basements built outside the footprint of buildings to have a depth of topsoil with appropriate water retention and drainage arrangements for the cultivation of gardens, there has to be a limit on how much of a garden can have basement construction beneath it. This is to ensure that trees can be planted to replace existing species that die and also to provide a hydraulic connection between the surface and the perched water table, so that rainwater can enter the ground to maintain the current status quo within the groundwater regime of the Borough.

9.7.7 There is clearly a difference between properties with large and small gardens. There is also a difference between buildings with traditional gardens (whether currently cultivated or not) and hard landscaped courtyard areas at the back of townhouses with adjoining mews properties close to and behind them.

9.8 Site Coverage by basements built outside the footprint of a house

9.8.1 The size of basements built outside the footprint of an existing house has to be limited for the following reasons

- a) Natural drainage of gardens which has to be achieved by connectivity between the surface and the Upper Aquifer or by rain water being able to soak away into the natural ground.
- b) Large tree and shrub planting to maintain the character of the gardens and landscape of residential areas within the Borough.

² The root protection area (RPA) is defined in BS5837:2012 as a layout design tool indicating the minimum area around a tree deemed to contain sufficient roots and rooting volume to maintain the tree's viability, and where the protection of the roots and soil structure is treated as a priority.

9.8.2 In all cases, every effort should be made not to alter the groundwater regime when a basement is designed and constructed. Also, it is good practice to avoid draining the new below-ground hard surfaces into the existing drains. RBKC's policy requires SuDS³ or other measures to reduce the volume and speed of water run-off entering the sewer system (Policy CE2 of the Core Strategy). Therefore, any additional water which is to drain away into the sewer system must be attenuated to a rate smaller or at least no greater than that generated on the site prior to a development happening. The principles of SuDS go further than this and generally require additional water volumes to be returned to the ground. Good practice in basement design and construction should consider this and where possible adopt it as a design principle. It is relatively easy to achieve when the near surface geology is gravel but not straightforward in clay subsoil.

9.8.3 Where the near surface subsoil is gravel, water that falls on gardens will be held in the topsoil and by the vegetation and then drain through to the gravel and into the Upper Aquifer. When a basement is built, water falling on the topsoil above it needs to be channelled or directed to an unbuilt area of the garden, so that it can enter the ground and find its way into the gravel and down into the Upper Aquifer. As a rule of thumb, 25% of the garden area is likely to be sufficient to enable this to happen. On this basis a new basement should not occupy more than 75% of the area of a garden.

9.8.3.1 It is important to arrange for the groundwater to be managed so that it is retained within the site and so that neighbouring properties are not affected by an increase in subsurface or surface flows of groundwater off the top of new basement slabs.

9.8.4 Where the near surface subsoil is clay, water that falls on gardens will be held in the topsoil and by the vegetation. It will drain through the topsoil until it reaches the clay, which will act as a barrier to the vertical flow of water. Some water will be absorbed by the clay surface. On sites with falls, water will gradually flow down any slope within the topsoil. The topsoil and ground will be waterlogged until the water evaporates or is absorbed by the underlying clay and dries out. The situation is not straightforward and will vary from site to site. It needs to be understood and the new basement construction should be arranged to maintain the surface water status quo. Care must be taken not to increase surface or near surface water flows on neighbouring properties. Also, existing ground water flows should not be interrupted, as this could cause an increase in waterlogging on neighbouring properties. There is no simple rule of thumb that can be applied here, but in situations where the garden and adjoining gardens are level, all water falling on the garden and basement footprint of the development property, should be retained on that property (or drained away using an attenuated system). To enable the clay subsoil to absorb some of the rainwater, a proportion of the garden should

³ SUDS refers to Sustainable Drainage Systems which employ techniques that manage surface water and groundwater sustainably.

not be built under and on clay sites this might be between 25% and 50%. On this basis a new basement should not occupy more than between 50% and 75% of the area of a garden on clay sites.

9.8.5 The need for the natural ground to be able to receive, absorb and then distribute the water in a way that does not change the overall balance of groundwater on a site or in an area, requires that there should be a depth of topsoil above any basement built under existing gardens. The 1.0m that is required to sustain planting should also be sufficient for the purpose of dealing with rainwater as described in 9.8.3 and 9.8.4.

9.8.6 The other factor that will need to be considered in limiting the size of a basement under a garden is the requirement to retain the ability to plant large trees. This requires areas of gardens to be kept clear of construction. In most cases a 3m strip at the rear of the garden will be sufficient to allow trees to grow, but this may depend on the nature of the garden and of the trees themselves. Where there are large gardens, a much wider strip or further areas should be left without subterranean construction beneath them to allow for extensive tree planting.

9.9 Adjoining Ownerships

9.9.1 Throughout this report, reference has been made to the possible effect that basement construction can have on the properties of adjoining owners.

9.9.2 As noted, the Party Wall act sets out what is to be done in situations where adjoining ownerships share a party wall. This is discussed in more detail in section 10.

9.9.3 In addition to the Party Wall Act or where it does not apply, the common law will apply. However, this is generally for resolving disputes and can be very costly, sometimes with unsatisfactory outcomes.

9.9.4 Good practice should apply in all cases. Owners planning basements below their buildings or rear gardens should consult with all of their neighbours in advance of proceeding with proposals to design and construct a basement. They should explain what they intend to do and show how they propose to address all of the issues contained within this report and comply with the requirements of the planning authority.

9.9.5 In cases where there is not a party wall but where an adjoining building is likely to be affected, it is possible to voluntarily proceed as if the Party Wall Act applies and it is in all parties interests that such a procedure should be followed.

9.9.6 Consultations with adjoining owners should extend to clearly discussing the proposals, stating what measures are being put in place to safeguard the adjoining properties and setting out clearly the construction methodology to include issues such as noise, vibration, working hours, overall programme, traffic impacts, control of ground movements and general inconvenience.

10.0

The Party Wall Etc Act 1996, in relation to Basement Design and Construction

- 10.1 As has already been noted, the Party Wall Act 1996 is a special piece of legislation designed to control development on each side of a party wall, so as to preserve its integrity and function. The Act also applies to construction in the ground that affects the property of a neighbour that is not actually a party wall, but which is close to the site of the construction work. The Act requires that notice is served on certain neighbours who can appoint their own surveyor to consider and advise them of the effect of the proposed works. Agreement for the works to proceed are contained within a Party Wall Award.
- 10.2 Overall stability of a party wall depends on restraint being provided from the properties on each side. They are shared structures, effectively in joint ownership of the parties who own the properties on each side of them. When one or both properties have multiple leasehold interests, the ownership issues are fairly complex.
- 10.3 The provisions of the Party Wall Act come into force when an adjoining owner proposes to carry out work in the ground within 3m of a party wall (or adjacent construction) or within 6m, if it falls closer to the party wall (or adjoining wall) than a plane defined by a line drawn at 45° from the bottom of the foundation of the wall. The Act also applies when works are proposed to a party wall by an owner on one side of it or if one of the owners wishes to raise the wall or extend it downwards for the purpose of development. In this report it is the application of the Act to work in the ground that is relevant. The rules that apply to work in the ground mean that almost all residential basement projects in RBKC require a Party Wall Award.
- 10.4 Generally party wall legislation recognises that party walls can be underpinned. Normally conventional underpinning is preferred. The party wall legislation does not permit complex reinforced concrete underpinning which is known as a special foundation under the Act. The use of these requires the express consent of the neighbour. Additionally a structural arrangement which depends on the structure of a building on one side of the party wall for its long term integrity and performance is not permitted without express consent. This is because a fundamental precept of the party wall legislation is that it should be possible to demolish and rebuild the entire property on one side of the wall (with the provision of lateral temporary support as required), without affecting the property on the other side. (Fig 12)
- 10.5 For basements formed by underpinning of party walls, the corbels of the strip footings are usually removed and the face of the underpinning is aligned with the wall above on the side of the basement construction. The underpinning then is stepped out at its base below the basement level to provide the same

degree of load spread as in the original wall. In practice, adjoining owners have a right to ask that the underpinning lines up with the face of their wall, so as not to disadvantage them if and when they decide to build a basement at a future date. This can be difficult to achieve in some soil types, but is possible using permanent shuttering and grouting. (Fig 9)

- 10.6 Often, to achieve an underpin that is restricted to the width of the wall above, the use of special foundations may be proposed. Occasionally, party wall surveyors on behalf of the adjoining owner will agree to Special Foundations being constructed where underpins are reinforced vertically to enable them to resist lateral loads.
- 10.7 Generally it is not desirable for foundations to be complex and to depend on arrangements such as offset piles on one side of the party wall or similar complex engineering solutions for the reasons described above. The adjoining owners, party wall surveyors or the engineers advising them may not agree to such arrangements being implemented in order to achieve basements in adjoining properties.
- 10.8 Where basements are formed with or without underpinning (for example by forming a contiguous piled wall along the line of the party wall), the Party Wall Act requires that the works are done in a way which does not cause damage to the party wall or change its status.
- 10.9 Most party wall surveyors interpret the Act as requiring structural damage to be avoided. Damage to masonry buildings as a result of ground movements associated with ground retaining structures is described in CIRIA report C5804 (Embedded Retaining Walls: Guidance for economic design). Structural damage is generally considered to occur if cracking takes place that is in excess of 5mm, classified as Category 2 Cracking (slight) in the CIRIA report, table 2.5. This means that when basements are procured they should be designed and constructed to limit the damage to an adjoining building to Category 1 but certainly no more than Category 2. BRE digest 251 (Assessment of Damage in Low-Rise Buildings) contains the same damage classification describing cracking of category 2 and less as aesthetic, with category 3 and 4 being serviceability damage.
- 10.10 The Party Wall Act contains provisions for dealing with damage as a result of works at an adjoining property. If the damage is cosmetic and confined to finishes (i.e. non-structural) then repairs and making good are relatively straightforward.

⁴ CIRIA is the Construction Industry Research and Information Association a member-based research and information organisation dedicated to improvement in all aspects of the construction industry.

- 10.11 When an adjoining owner receives a notice of work under the Party Wall Act, concerns are immediately raised and the whole process can be stressful and involve a great deal of emotional energy, unless it is well handled by the promoter of the work. This applies equally where works are proposed to buildings where no party wall exists but when the adjoining owners property is likely to be affected.
- 10.12 The following principles are suggested in relation to party walls and adjacent properties when a building owner proceeds with the procurement of a basement extension.
- Any underpinning to the party wall should be symmetrical and no wider than the party wall. The underpin should be widened at its base to be at least the same width as the existing foundations.
 - Any additional vertical loads associated with the construction of the basement should be supported independently of the party wall.
 - The new basement structure must provide adequate lateral support for the party wall and for the ground beneath the party wall.
 - The works need to be designed and constructed with the aim of not causing structural damage to the party wall or the adjoining building.
- 10.13 Supporting party walls off reinforced concrete basement boxes on one side of the wall is not recommended as it changes the nature of a party wall from being a structure that has its own independent foundations to one that is reliant on the ongoing existence of a building on one side of it.
- 10.14 Under certain conditions the adjoining owner, advised by his party wall surveyor, can request that a sum of money is held in Escrow as security, for example, to step in and complete works to a party wall or the neighbouring building to cover cases where building works commence but are not completed. It can also be used to pay for the repair of any damage caused as a result of the construction work.

11.0

Sustainability Issues

- 11.1 When considering the design and construction of a residential basement there are sustainability considerations associated with the construction and the long term use of the space.
- 11.2 All construction has a carbon footprint and generates CO₂ emissions. Below-ground structures in contact with the subsoil are generally always built in concrete, which has a high embodied carbon content. Measures are now available to reduce carbon by replacing some of the cement with cement substitutes (GGBS) which are natural by-products of coal-fired power station and steel production or other pozzolanic material. Aggregates can also be used from recycled sources to reduce the depletion of our natural resources although this can sometimes increase the embodied carbon in new concrete structures, due to the extra transport required.
- 11.3 Another significant construction-related aspect is waste. The construction industry produces around 25% of the waste in the UK each year, 13% of which is unused materials. This represents three times more waste than is produced by the total of all UK households combined. National legislation and planning policies are addressing these issues and they should be considered on basement construction projects. In addition to taking steps to reduce waste, the disposal of waste is equally important. Much of the waste from construction is potentially hazardous and disposal must be carefully planned to minimise environmental damage. Some waste can be recycled, but is not. It is reasonable to require that all such materials are recycled, even if some additional vehicle movements are generated by this. Other non-recyclable waste should be segregated. All aspects of waste reduction, management and disposal should be set out in a site Waste Management Plan. This is already a requirement of larger construction projects.
- 11.4 The principles of lifetime homes should be applied to residential basement projects. This means creating spaces which are flexible and adaptable and which can accommodate changes in the lifestyles of the occupants, quickly, cost effectively and without major upheaval. Very bespoke single use developments could, in time, become difficult to use, so at the planning stage, consideration should be given to alternative uses and configurations of the space in the future.
- 11.5 Once constructed, basements tend to perform much better in environmental terms than above ground construction. They are not subject to extreme variations in temperature which result in high heating or cooling loads. They also have high thermal mass which can be used beneficially to retain the space at a regulated temperature. It is not always possible to incorporate insulation on the outside surfaces of basement retaining walls or below their slabs and the building regulations requirements sometimes result in

insulation being applied internally. This negates the advantages of thermal mass and runs the risk of requiring more heating and cooling.

- 11.6 Basement drainage often has to be pumped. This could be considered as unsustainable but generally the power consumption of pumps to deal with foul water is small. If pumping is needed to control ground water, this can be much more significant. Low energy use can be achieved through using the basement structure as the primary barrier to water ingress and only pumping the minor seepage that might occur through it. Major pumping to control groundwater in domestic basement projects should be discouraged.

12.0

Construction Issues

- 12.1 All construction is disruptive and involves noise, dust, vibration, delivery of materials to and from site, access to the site by construction operatives and access for plant, machinery and equipment. Most construction sites in inner London involve the suspension of car parking bays and the establishment of welfare facilities for the workers on or adjacent to the site.
- 12.2 Residential construction projects can vary from minor alterations works to much larger scale works to an existing building. Where the works involve the excavation of a new basement below or adjacent to an existing building, they tend to be at the upper end of the scale of domestic construction projects as far as the potential for disruption to neighbours is concerned. Basement projects also tend to go on for much longer than projects which involve works only to the above ground elements.
- 12.3 There are many ways to mitigate against the disruptive effects of construction and in cases where the disruption has the potential to be most severe, as with basement construction projects, it is reasonable for RBKC to require that undertakings are given at the planning stage in respect of access, vehicle movements, working hours, noise, vibration and public safety.
- 12.4 The design and construction of basements requires a significantly higher degree of specialised expertise than other forms of construction. Health and safety issues and construction risks are more relevant. The construction process can be made more complex when the building remains occupied and both the underpinning and excavation have to be carried out using tunnelling techniques.
- 12.5 Construction of basements under existing buildings is a slow process. There is a requirement to remove large quantities of bulk excavation from site and to deliver construction materials and equipment.
- 12.6 It is possible for there to be more than one construction project in one street. Construction methodology and in particular the Construction Traffic Management Plan for a project must have regard to the impact of multiple permissions for basements in a street or area. This is particularly important where the streets are narrow or have limited access.
- 12.7 In order to assist with controlling vehicle movements, construction vehicle trips should be limited for each site. While it is inevitable that at least one car parking space will be required for a skip, consideration should be given to requiring all other materials to be stored within the site and not on pavements or roads. Consideration should be given to limiting the number of parking spaces which the contractor can apply for. Parking facilities for construction workers should not be provided. Traditional white vans should also be restricted and if required, should be counted as vehicle trips.

- 12.8 In accordance with good practice all sites should be fully hoarded and secured. Skips on the road should either be within a hoarding or have dust protection. They should have appropriate signage and lighting provided. Conveyors for the removal of excavated material, if required, must have suitable protection for pedestrians. Skips should generally be restricted to normal size units for most residential streets. If larger skips are possible, because of the site layout or nature of the street, they can be considered if they involve fewer vehicular movements. If skips are to be placed above basement vaults, then these vaults should be assessed by a Chartered Engineer and consideration should be given to installing back-propping within the vaults.
- 12.9 Disposal of groundwater must follow good practice and where specifically requested done in a way that is agreed with the relevant authority. Silt traps should be provided to remove all fines prior to disposing of the water. Silt needs to be placed in skips or bags for separate disposal.
- 12.10 Water used to clean concrete wagons or concrete pumps and other equipment must not be discharged into road gullies. It should be discharged into skips or containers and stored for a minimum of 12 hours to allow fines to settle out, following which excess water may be disposed of as in 12.9 above. All fines or hardened concrete should be removed from site as in 12.9 above.
- 12.11 All basement projects should have a Construction and Demolition Management Plan (CDMP) and a Construction Traffic Management Plan (CTMP) – these should provide details of:
- overall programme
 - working hours
 - materials handling and storage
 - protection of existing fabric when works are proposed to a listed building
 - traffic management/access routes
 - suspension of parking bays
 - site hoardings
 - welfare facilities
 - vehicle size and numbers
 - protection of vaults and public utilities
 - controls on construction vehicles waiting in the vicinity
 - a detailed construction methodology to include demolition, excavation, disposal of rain and ground water and methods of new construction

- a clear construction sequence illustrated with sketches showing how the construction relates to the design and in particular how temporary propping and support is to be provided for the basement construction.
- details of diversion of working sewers, if intended
- how materials are to be delivered to site and placed in the construction without damaging the existing buildings
- how excavated materials are to be removed from site without damaging the existing buildings
- the plant and equipment that is to be used including noise levels
- how plant and equipment is to be placed on site and later removed from it- a statement describing how noise and vibration from construction activities will be controlled and mitigated, including details of any monitoring that is proposed
- an undertaking not to dewater in ways that remove fines from existing subsoil, (generally dewatering of the Upper Aquifer by well point pumping should be avoided)

13.0 Recommendations for Basement Design and Construction

13.1 Relevance

- 13.1 These recommendations apply to residential buildings constructed traditionally of masonry with timber upper floors. Internal loadbearing walls are either of masonry or timber stud construction, or a combination of both.

13.2 General

- 13.2.1 The construction of basements below or next to residential buildings is technically challenging. Building owners (freeholders or leaseholders) who seek permission for such projects need to recognise the special nature of the work they propose to undertake and demonstrate through the pre-planning work they commission, that they are employing designers, in particular Chartered Structural or Civil Engineers, with the relevant experience and skills. For the post planning construction stage, the building owner must undertake to retain the services of their Chartered Structural or Civil Engineer to detail the structural works, review the contractor's proposals, method statements and temporary works proposals and regularly monitor the construction. If for some reason the appointment of the Chartered Structural or Civil Engineer is terminated a replacement Engineer with equivalent relevant experience should be appointed and retained. The building owner must appoint a contractor with relevant expertise and experience. This should extend to the individuals within the contractor's organisation and any subcontractors they employ and not just be corporate experience of the businesses.
- 13.2.2 Each basement proposal is unique. Generic basement designs are not appropriate and should not be permitted for consideration at planning. Each application must demonstrate a recognition and understanding of the special and unique factors that apply in each case.
- 13.2.3 Applicants who wish to construct residential basements beneath or next to their properties need to consider both the design and construction issues at the planning stage. An Engineering Design and Construction Statement (EDCS) must be proposed (see 14.4). In overall terms it must demonstrate what is proposed to be done in engineering terms. In order to do this, the engineering design has to be advanced to at least a well worked out Detailed Proposals Stage (as set out in the Services of ACE⁵ Agreement 1: Design, 2009 Edition. In addition to the design, the applicant must consider, at the planning stage, what the construction process will be to implement the design. Generic construction statements are not sufficient.

⁵ ACE is the Association for Consultancy and Engineering.

A clear sequence and method of construction must be developed that is specific to the project and that reflects the design. There is an overlap between design and construction in basement projects where the early permanent works might be part of the temporary works. This must be recognised in the design and construction statements at the planning stage. These design and buildability statements are different from a traditional construction methodology statement which deals with issues such as noise, working hours, welfare, nuisance, vehicle movements etc.

- 13.2.4 Because basement construction projects in residential areas are slow and generally more extensive in their scope than above-ground extension or alteration projects, it is reasonable to expect that there should be special measures put in place to mitigate the effects of the construction activities on the public and neighbouring residents. Noise and vibration limits should be set and checked during the works by monitoring. Vehicle movements in residential streets must be controlled and limited together with disruption to pedestrians, cyclists and drivers using the street and parking on it.
- 13.2.5 Prior to the submission of a planning application, there should be effective consultation with adjoining owners and their representatives which should explain the proposals to these third parties and set out what the implications of the works are likely to be. This needs to deal with the final proposals and the works that will be done to construct them. Evidence of this consultation should be presented with the planning application. Where an adjoining owner does not wish to engage in consultation, it will be sufficient for the applicant to have provided the details of the proposals and what they mean for the adjoining owner, to them.

13.3 Specific Recommendations

- 13.3.1 New basements under terraced or semi-detached houses founded in clay or fill with a history of structural movement, should generally not be formed by underpinning the party walls of the property.
- 13.3.2 New basements under gardens close to existing buildings founded in clay subsoil with a history of structural movement should generally not be formed by underpinning the existing building.
- 13.3.3 The depth of underpinning to party walls of semi-detached or terraced houses should generally be limited to 4m below the underside of the foundations of the party walls. Deeper basements should be avoided or else formed using piled walls if feasible.
- 13.3.4 Underpinning that extends into the Upper Aquifer in Gravels and Sands should generally be avoided where possible. Alternative techniques for forming basements in these ground conditions should be considered.

- 13.3.5 The footprint of new basements built under front or rear gardens of existing houses should be limited and not occupy the whole of the garden area in order to maintain the surface water and ground water status quo on the site. Each site needs to be looked at individually (see 9.8) but generally the following limits should be considered
- a) In sites where the near surface conditions are gravel or sands, no more than 75% of the area of a garden should be built under with a basement.
 - b) In sites where the subsoil is clay, no more than between 50% and 75% of the area of a garden should be built under with a basement.

In referring to 'a garden' this guidance should apply to front and rear gardens separately when both exist.

The requirement that provision be made for large tree and shrub planting to maintain the character of gardens in the Borough may further restrict the area of gardens which can be built under.

- 13.3.6 Basements below rear gardens should generally be formed within a bored piled wall, a sheet piled wall or a king post wall. The use of reinforced concrete walls formed sequentially using underpinning techniques should generally not be permitted close to boundaries or existing buildings.
- 13.3.7 Basements formed below gardens must have 1.0m of topsoil above the waterproofing and insulation layers to allow for planting and to be able to maintain the surface water and ground water balance on a site. Appropriate drainage must be provided to prevent the ground becoming waterlogged, but the direct connection of drains into main drains and sewers should not be permitted. Water retention to support plant life must also be considered.
- 13.3.8 If a basement proposal falls close to or within a Root Protected Areas of a tree (as defined in BS 5837, 2012) a report of an arboriculturist should be provided to support the proposals.
- 13.3.9 Basements proposed within areas with critical drainage problems should have a site specific flood risk assessment carried out and provided with the application. Measures to prevent flooding, protect against its effects and to reduce surface water run-off need to be included with the proposals for planning.
- 13.3.10 Basement proposals within areas with critical drainage problems also need to consider how to prevent flooding from sewers and surcharged drains, for example by including positively pumped devices. The application needs to show how flooding of the basement is prevented and also how the basement drainage will work when the main sewers are surcharged and unable to function.

13.3.11 Ground water must be considered and designed for at the planning stage. Where a basement is to be built below the level of the perched water table (upper aquifer) a clear strategy is needed for the construction and long term performance of the basement. This needs to include considerations of whether or not the ground water levels will be affected and measures to mitigate this, particularly where adjoining buildings have their lowest floors close to the water table. Cumulative effects must also be considered. The issues raised in sections 9.4, 9.5 and 9.6 of this report all need to be considered and taken into account in the proposals.

14.0

Work to be done and/or submitted when a planning application is made for the construction of a basement in a residential building in RBKC

14.1 Actions by the Applicant

- 14.1.1 Appoint design team including a Chartered Structural or Civil Engineer experienced in the design and construction of basements in residential buildings, to design the new basement structure and monitor its construction. The engineers' brief should include reviewing the contractors' construction proposals, method statements and temporary works. Provide evidence of this appointment.
- 14.1.2 Undertake to retain the services of the Chartered Engineer or if, for some reason, the Engineers' appointment is terminated, appoint a replacement Engineer with relevant expertise to continue with the project both as designer and construction monitor.
- 14.1.3 Engage in consultation with adjoining owners and nearby residents to explain what is proposed, what the implications for the owners and residents will be and what mitigation measures are to be put into place. Where neighbours refuse to engage in consultation, provide evidence that the relevant information has been provided to them.
- 14.1.4 Initiate Party Wall procedures with adjoining owners and provide evidence that Party Wall Award negotiations are being progressed.
- 14.1.5 Undertake to engage or provide evidence of engagement of a builder or contractor experienced in the construction of basements similar to that being proposed on the site.
- 14.1.6 Require the design team, and particularly the Chartered Engineer and contractor to follow the guidance of this 2012 report and good industry practice.

14.2 Preplanning Work – Desk Study and Site Investigation

- 14.2.1 A thorough desk study must be carried out to establish at least the following
 - a) The site history
 - b) The age of the property
 - c) The topography

- d) The geology and ground conditions
 - e) Rivers and Watercourses whether existing or old
 - f) The surface water and ground water regimes
 - g) Flood risk issues
 - a) Fluvial flooding
 - b) Surface water flooding
 - c) Critical drainage flood potential
 - h) Underground infrastructure, particularly LUL assets, Main Drains and Utilities
- 14.2.2 Visual assessment of the existing building and its neighbours and Physical Investigations
- 14.2.3 A visual assessment of the existing buildings and the adjoining buildings should be undertaken to look for origins of historic or ongoing movements and to establish the likely overall condition of the buildings. Past alterations to the structure should also be considered. This assessment should inform the feasibility of the basement proposals and be used to determine appropriate engineering design solutions. The visual assessment should extend to looking at buildings in the area generally.
- 14.2.4 A site investigation must be undertaken to establish the ground conditions including the geological strata and the presence of the Upper Aquifer. It is particularly important to distinguish between sites where the subsoil is clay and those where it is sand or gravel.
- 14.2.5 Ground water monitoring should be implemented where the Upper Aquifer is present, so that a thorough understanding of the ground water regime on the site is known and how this relates to the adjoining and nearby properties.
- 14.2.6 Trial pits must be dug on all walls to be underpinned or have piled walls built close to them to establish the details of the existing foundations and their condition. The Engineer needs to decide on how extensive these trial pits need to be.
- 14.2.7 Opening up of the existing structure may be needed to establish its details and condition if these are important (see section 14.4.1.c below).
- 14.2.8 The results of these physical investigations to be clearly presented with accompanying drawings and sketches including plans and sections.

14.3 Engineering Design Work

- 14.3.1 For the planning application, the engineering design should be advanced to Detailed Proposals Stage (see Clause 13.2.3). Appropriate drawings must be

prepared and submitted that describe the detail of the engineering designs and that illustrate how it addresses all of the issues raised in this report. In particular the engineering design must fully address the following:

- Groundwater
- Drainage
- Flooding
- Vertical loads
- Lateral loads
- Movements
- Ground Conditions
- Trees and planting
- Infrastructure
- Vaults
- Existing Structures
- Adjoining buildings and structures
- Overall stability (permanent and temporary case)
- Underpinning (if proposed)
- Piling (if proposed)
- Special considerations e.g. cantilevered stone stairs and landings, balconies or other important functions or features in an existing building which need special consideration

14.4 Engineering Design and Construction Statement (EDCS)

14.4.1 An engineering design and construction statement is required to accompany the planning application. This statement needs to show how all relevant design issues have been addressed and how these relate to or influence the construction of the basement. No basement design should be undertaken without consideration by the designer as to how it can be constructed. In particular the EDCS should clearly contain the following information:-

- a) The Desk Study information and an analysis of the findings in relation to the proposals
- b) The physical investigations (see 14.2.4 to 14.2.8) with an engineering interpretation of the results

- c) An appraisal of the existing building structure and an understanding of the structural arrangement and condition of the adjoining buildings (see 14.2.3) with particular reference to condition and history of movements
- d) A clear statement on groundwater with relevant proposals to deal with it when the new basement is below the water table level. In such cases, consideration must be given to the possible cumulative effect of the basement, with other basements nearby, on the groundwater regime. Where the groundwater at a site lies close to the underside of existing ground or lower ground floor levels of the building or those of its neighbours, the potential for the new basement to cause a local rise in the water level of the Upper Aquifer must be considered and dealt with in the proposals.
- e) An analysis of the surface water conditions on the site and how surface water will be dealt with when the basement has been constructed, demonstrating how the status quo is maintained without increasing surface water flows onto adjoining properties.
- f) A statement on flooding and flood risk taking account of fluvial flooding, surface water flooding and critical drainage issues (including sewer flooding) explaining how these are accounted for in the design. In sites within areas with critical drainage problems as full Flood Risk Assessment (NPPF compliant) should be provided.
- g) Consideration by the designer as to how the basement structure is likely to be built. This should include the envisaged sequence of construction, temporary propping and the relationship between the permanent and temporary works. In particular, attention must be paid to how the vertical and lateral loads are to be supported and balanced at all stages and what must be done to limit movements of the existing structure and adjoining buildings.
- h) An assessment of movements expected and a statement of how these will affect the existing property, adjoining buildings and other adjacent structures. This assessment can be by calculation or empirical means with appropriate justification. It needs to cover both short term and long term movements relating to the construction and the performance of the permanent works. The design and construction methodology should aim to limit damage to the existing building on the site and to all adjoining buildings to Category 2 as set out in CIRIA report 580 (see para 10.8) and the Engineering Design and Construction Statement should clearly explain how this is to be achieved.
- i) How any nearby trees are being dealt with and protected.
- j) A justification of the size of the basement in relation to groundwater and landscape (9.8).

- k) Any other site specific issues that are relevant and which have been considered in the design, such as major infrastructure and unusual ground conditions.
- l) Any building specific issues that are relevant such as the presence of fine cantilevered stone stairs in the building or adjoining properties that are particularly susceptible to movement, with proposals for their protection.
- m) Details of movement monitoring to be carried out during the construction works, including “traffic light” trigger levels and actions to be followed by the contractor.

14.5 Construction and Demolition Management Plan (CDMP) and Construction Traffic Management Plan (CTMP)

These need to be prepared and submitted. They must address all of the points listed in 12.11. Particular attention must be given to how plant and materials for the basement construction are to be moved onto site and how excavated material is to be removed with particular reference to the protection of the retained elements of existing buildings. This is particularly important when basements are proposed in the gardens of listed buildings. Also the provision of temporary works, particularly the propping of underpinning, piling or other structures forming the basement retaining walls needs to be described and drawn by both layouts and sequence of construction. The CDMP should be such as to show how the construction of the basement reflects the design of the structure and the requirements or assumptions of the designers in their work.

14.6 Sustainability Statement

A statement must be included to show how sustainability issues are being addressed as part of the basement design and construction. This should include any information on any pumping needed to control groundwater or to drain the property.

14.7 Landscaping and Planting Statement

Where basements are proposed beneath gardens, details should be provided of how the garden will be replanted, including confirmation that the requirement of a minimum depth of 1m of soil is to be provided with appropriate drainage and water retention provisions. If the basement is close to or intrudes into the root zones of trees, an Arboriculturalist’s report is required, together with confirmation that the guidance in 9.7 is being followed unless the Arboriculturalist recommends further measures to protect existing trees.

14.8 Drawings to be provided (minimum requirement)

- Site plan
- Survey Plans, Sections and Elevations of the existing building and all adjacent buildings
- The location of existing trees and their species on or within 6m of the site and a description of the existing garden and paved areas of the building and adjacent properties
- Drawings of the existing building showing its structure
- Architectural plans, sections and elevations of the proposed works
- Structural engineering plans, sections and details of the proposed works
- Drawings showing the groundwater levels and the relationship of the groundwater to the proposed new basement. The drawings should show the direct of flow for both groundwater and surface water run-off.
- Drawings to illustrate how it is envisaged that the project will be built, showing a sequence of works and the envisaged temporary works, particularly propping to limit and control ground movements

These drawings are to be referenced in the relevant ECDS, CDMP and other statements provided for planning.

15.0 References

Documents

- RBKC Town Planning Policy on Subterranean Development Phase I Scoping Study 2008 by Arup Geotechnics
- RBKC Draft Surface Water Management Plan by Halcrow
- RBKC Strategic Flood Risk Assessment August 2009 JBA Consulting
- RBKC Planning Policy documents
- CIRIA C580 Embedded Retaining Walls: Guidance for Economic Design
- BRE Digest 250 Assessment of Damage in Low-Rise Buildings
- Party Wall Etc. Act 1996
- BS5837 2012 Trees in Relation to Design, Demolition and Construction

Appendices

Appendix A

Figures

Figure 1	Historical Development of RBKC c. 1745
Figure 2	Historical Development of RBKC c. 1851
Figure 3	Historical Development of RBKC c. 1862
Figure 4	Historical Development of RBKC c. 1880s
Figure 5	Historical Development of RBKC c. 2010
Figure 6	General Topography, Geology and Historic Water Courses
Figure 7	Detailed Topography, Geology and Historic Water Courses
Figure 8	Geological Sections
Figure 9	Typical Underpinning Detail to Form a Basement
Figure 10	Basement Construction using a Piled Wall
Figure 11	A Typical Sequence of Construction for Underpinning
Figure 12	Special Foundation
Figure 13	Typical Cross-Section for a New Basement
Figure 14	Sequence of Construction using Low Headroom Piling Rig
Figure 15	Bottom-Up Basement Construction using Piled Walls
Figure 16	Potential Effects of Basement Construction for Houses Founded on Shallow Foundations
Figure 17	Typical Section with a Basement under the House and part of the Garden
Figure 18a	Bottom Up Construction
Figure 18b	Top Down Construction
Figure 19	Indicative Ground Movements due to Basement Excavation
Figure 20	Indicative Ground Movements due to Construction of a Large Basement with Piled Walls
Figure 21	The Upper Aquifer and Potential Flow of Ground Water
Figure 22	Potential Impact of Basement Construction below the Perched Water Level
Figure 23	Overtopping Inundation
Figure 24	Breach Inundation
Figure 25	Local Surface Water Flood Risk Zones
Figure 26	Critical Drainage Areas

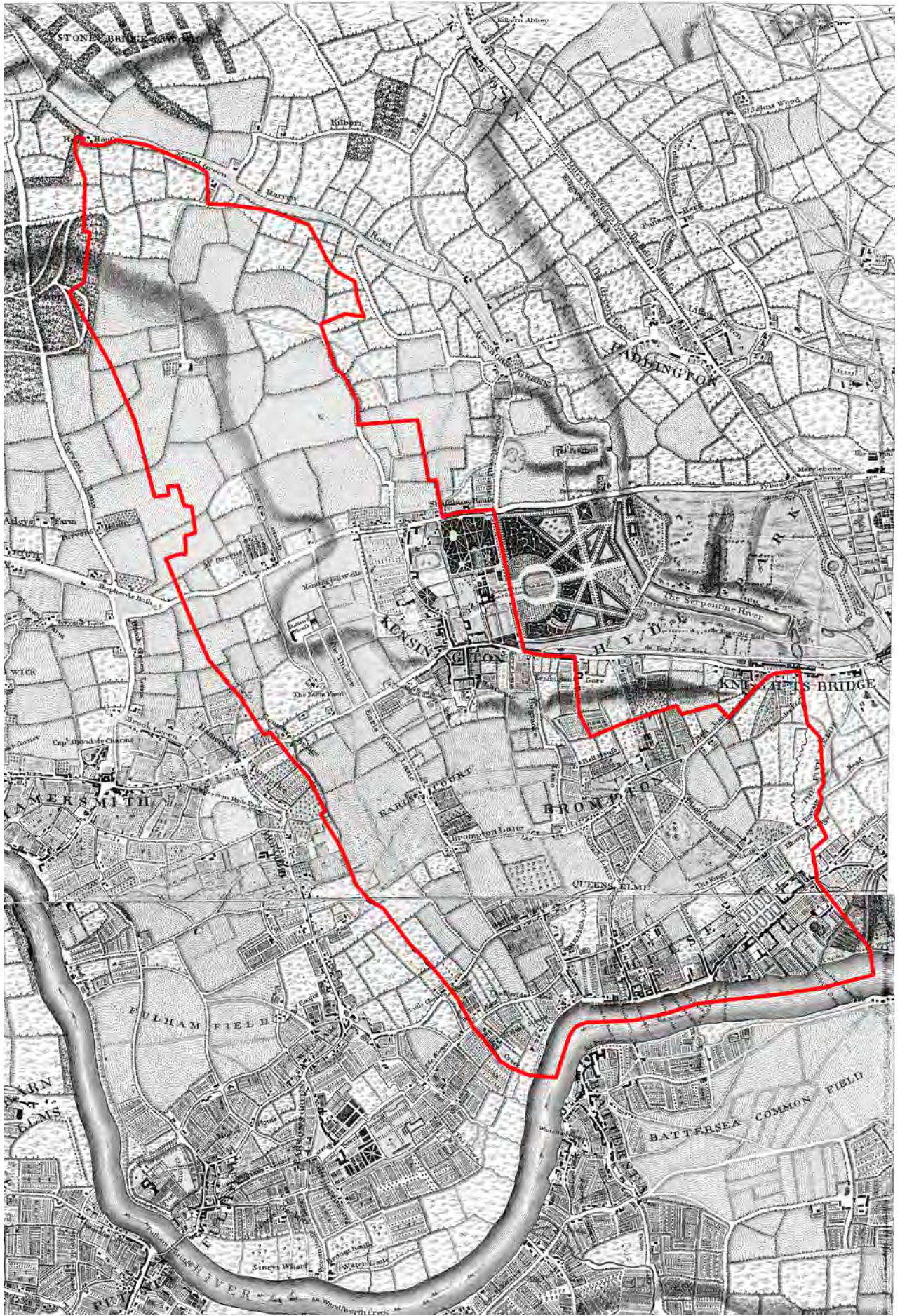

Roque, 1745

ROYAL BOROUGH OF KENSINGTON AND CHELSEA
RESIDENTIAL BASEMENT STUDY REPORT

HISTORICAL DEVELOPMENT OF RBKC
c. 1745

0954/130

Figure 1

DEC 2012

Alan Baxter

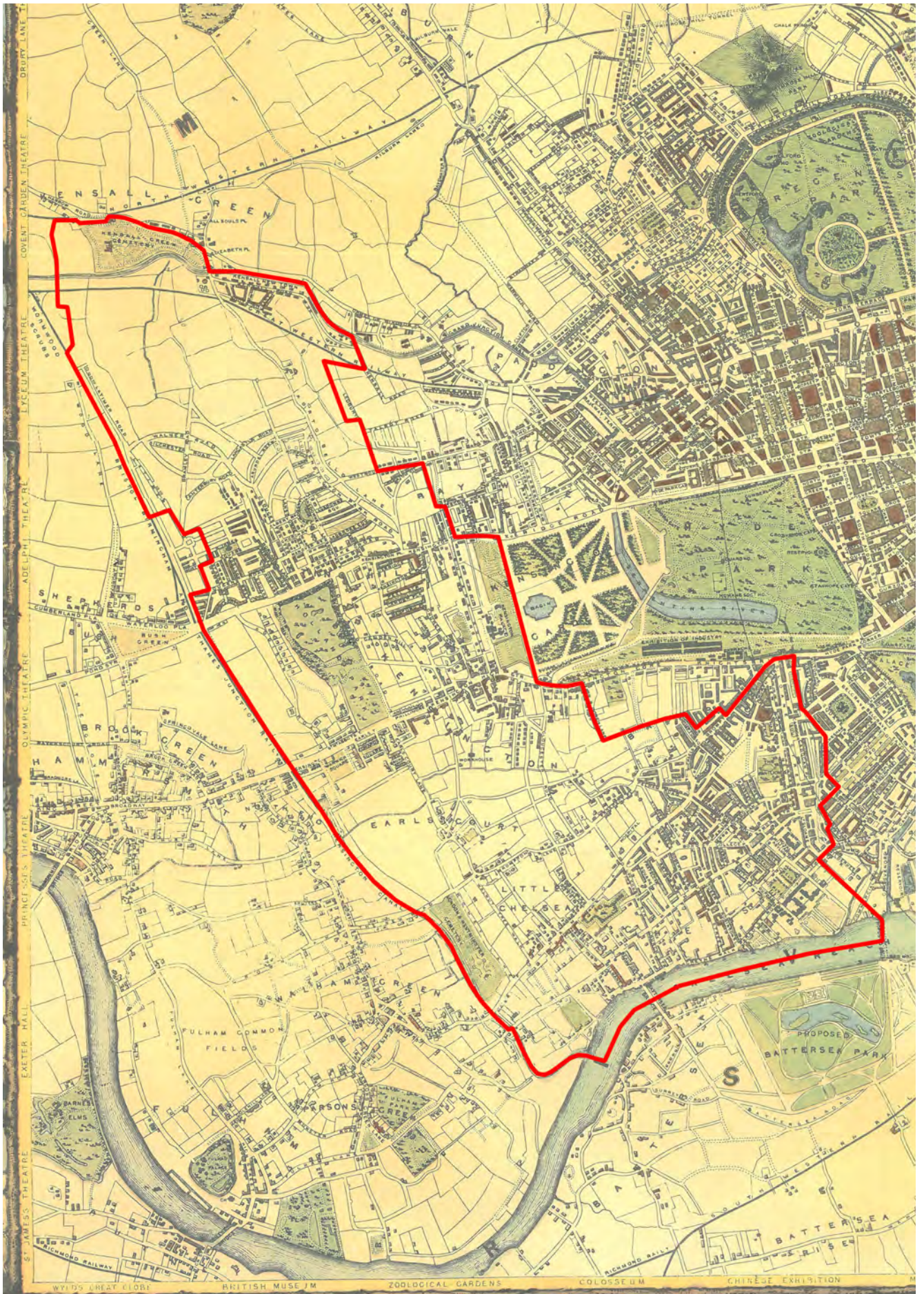

Charles Booth, 1851

ROYAL BOROUGH OF KENSINGTON AND CHELSEA
RESIDENTIAL BASEMENT STUDY REPORT

HISTORICAL DEVELOPMENT OF RBKC
c. 1851

0954/130

Figure 2

DEC 2012

Alan Baxter

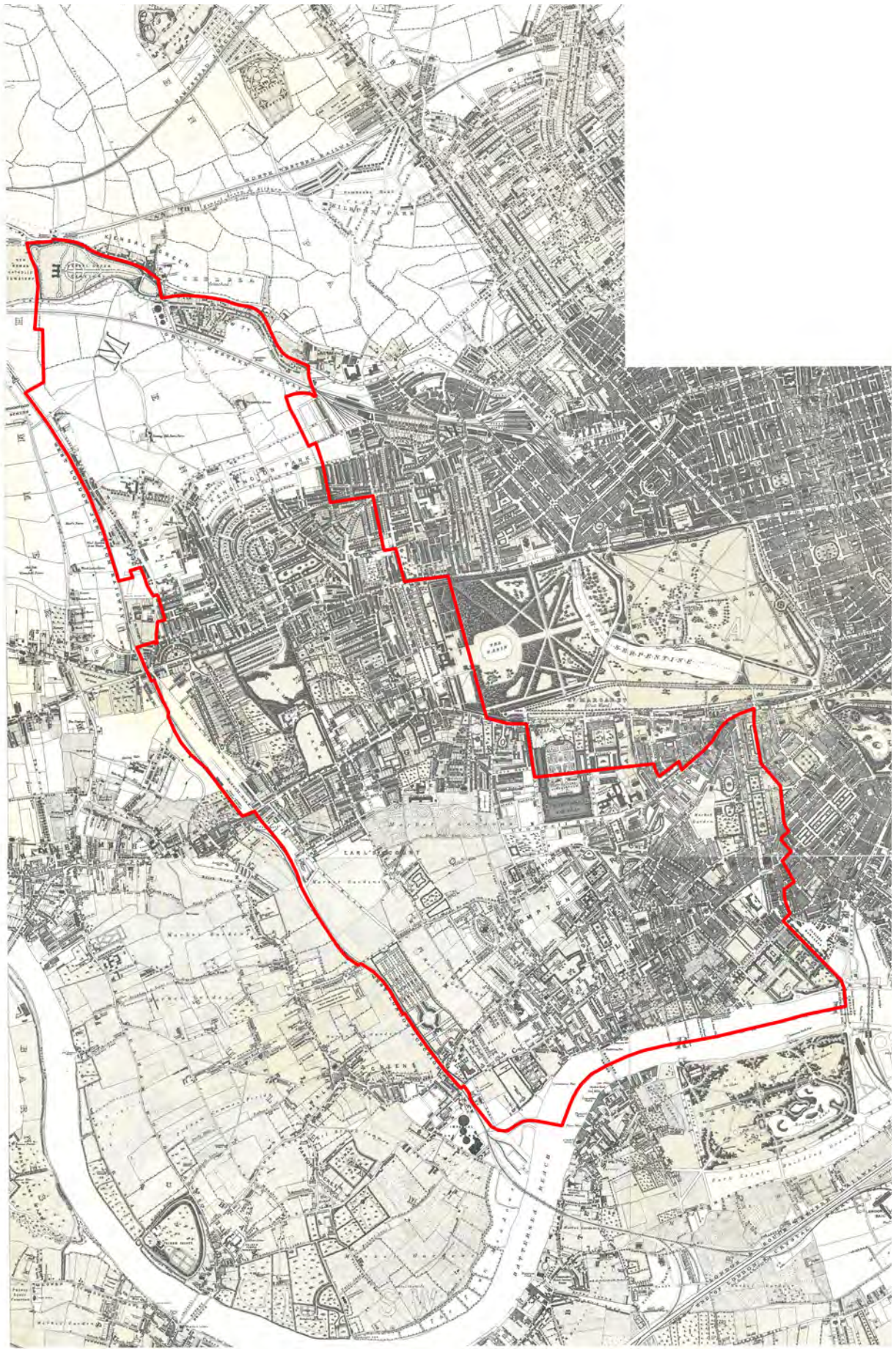

Stanford, 1862

ROYAL BOROUGH OF KENSINGTON AND CHELSEA
RESIDENTIAL BASEMENT STUDY REPORT

HISTORICAL DEVELOPMENT OF RBKC
c. 1862

0954/130

Figure 3

DEC 2012

Alan Baxter

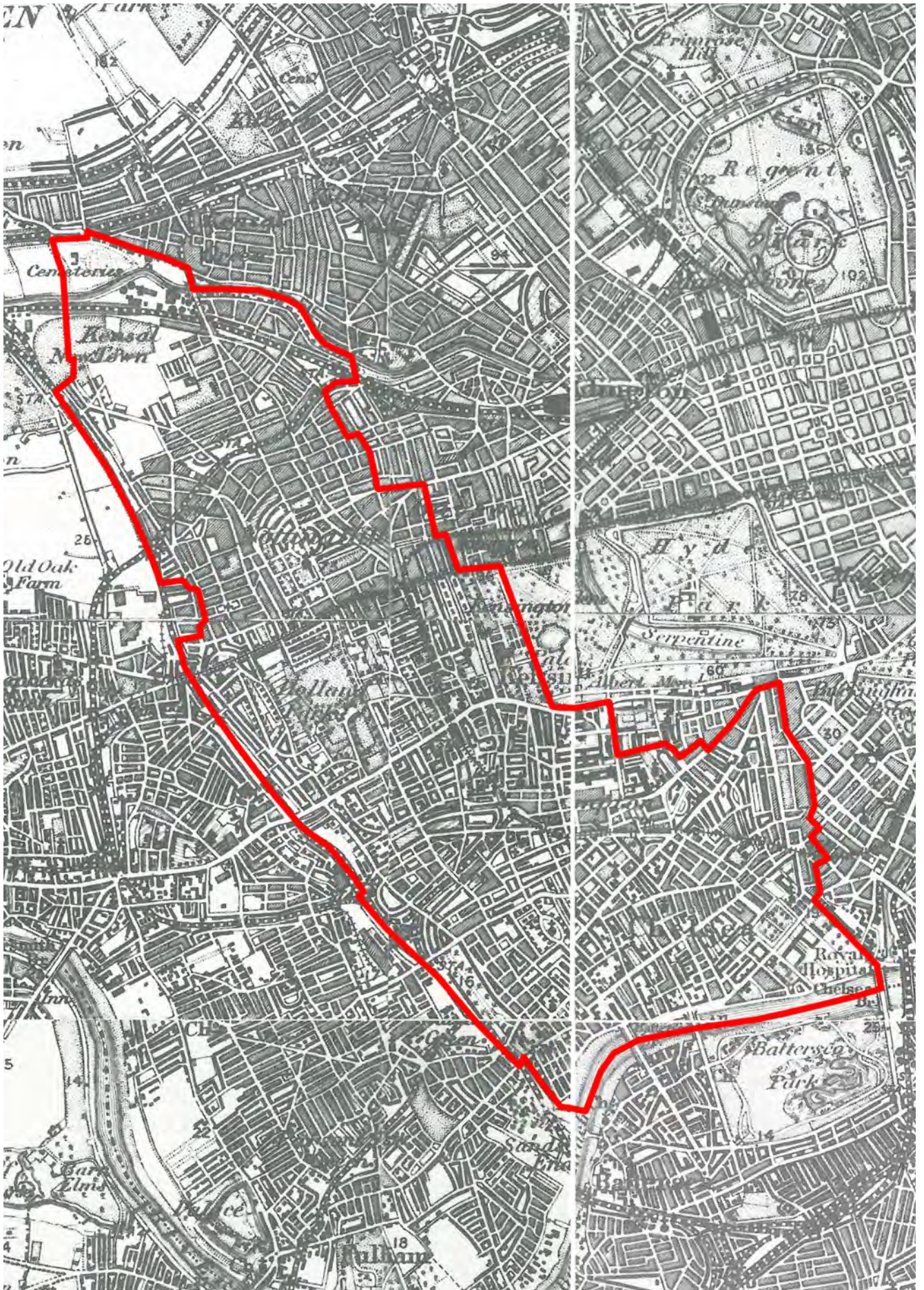

Unknown, c.1880s

ROYAL BOROUGH OF KENSINGTON AND CHELSEA
RESIDENTIAL BASEMENT STUDY REPORT

HISTORICAL DEVELOPMENT OF RBKC
c. 1880s

0954/130

Figure 4

DEC 2012

Alan Baxter

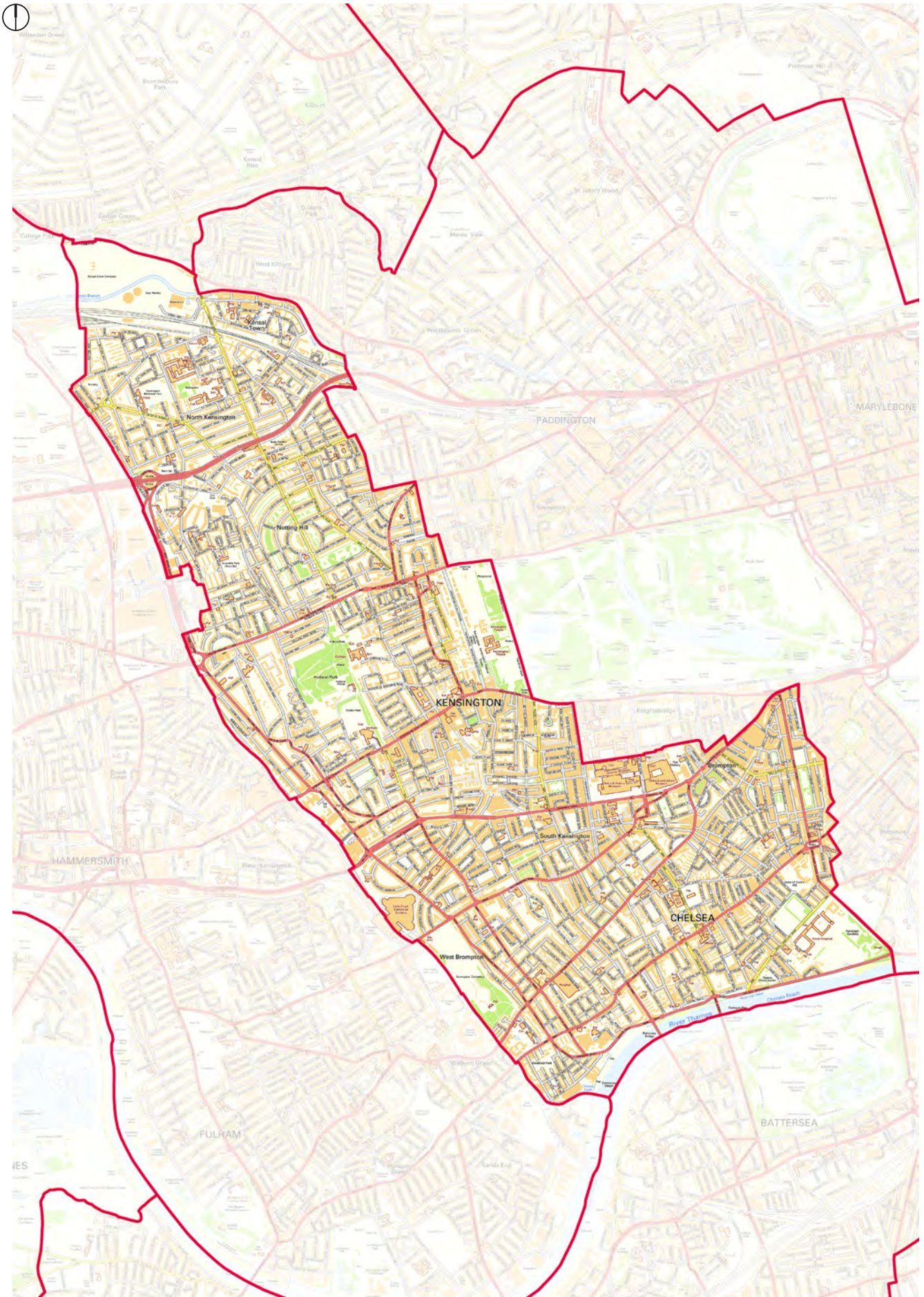

Provided by RBKC

ROYAL BOROUGH OF KENSINGTON AND CHELSEA
RESIDENTIAL BASEMENT STUDY REPORT

HISTORICAL DEVELOPMENT OF RBKC
c. 2010

0954/130

Figure 5

DEC 2012

Alan Baxter

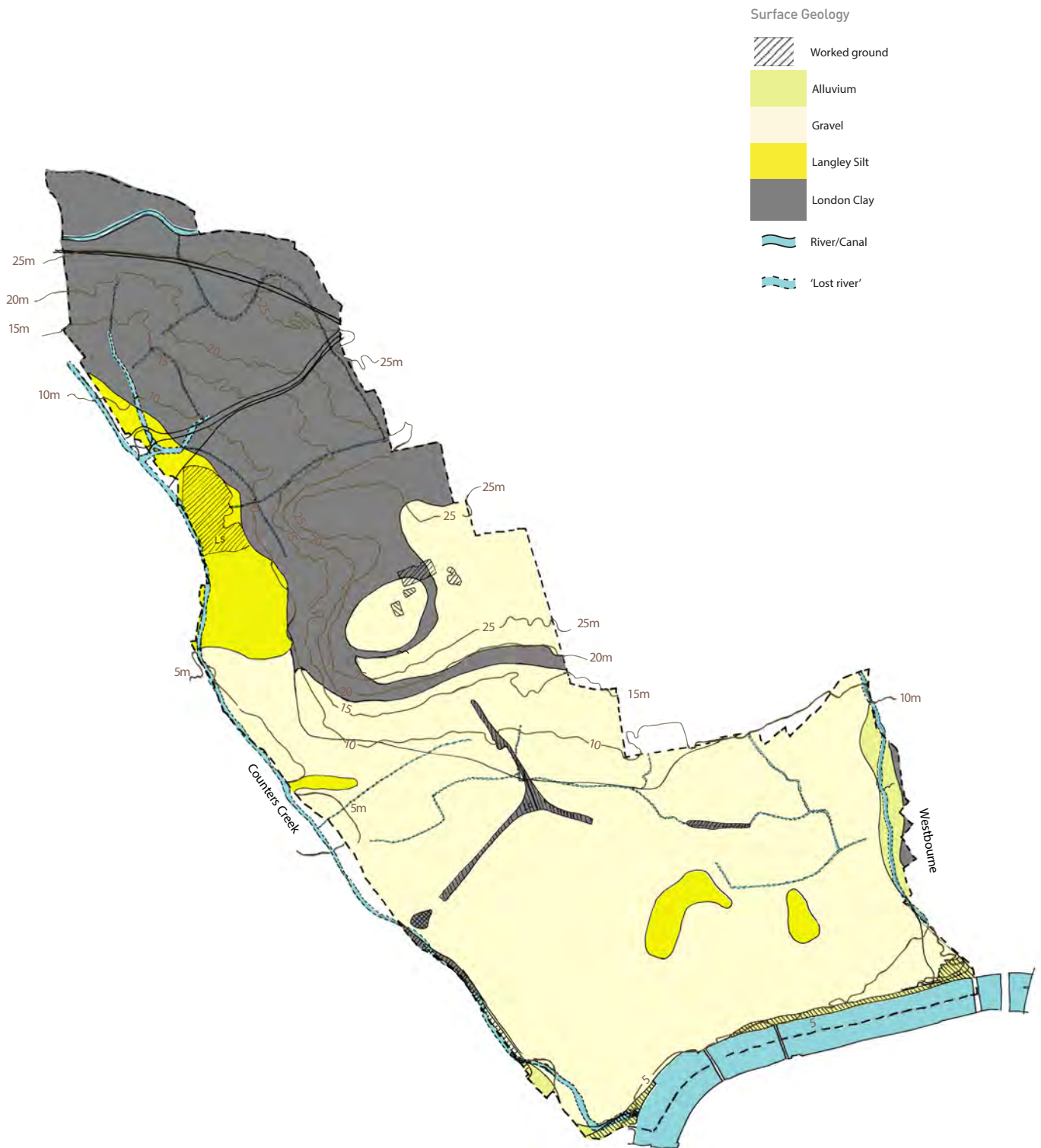



Surface Geology

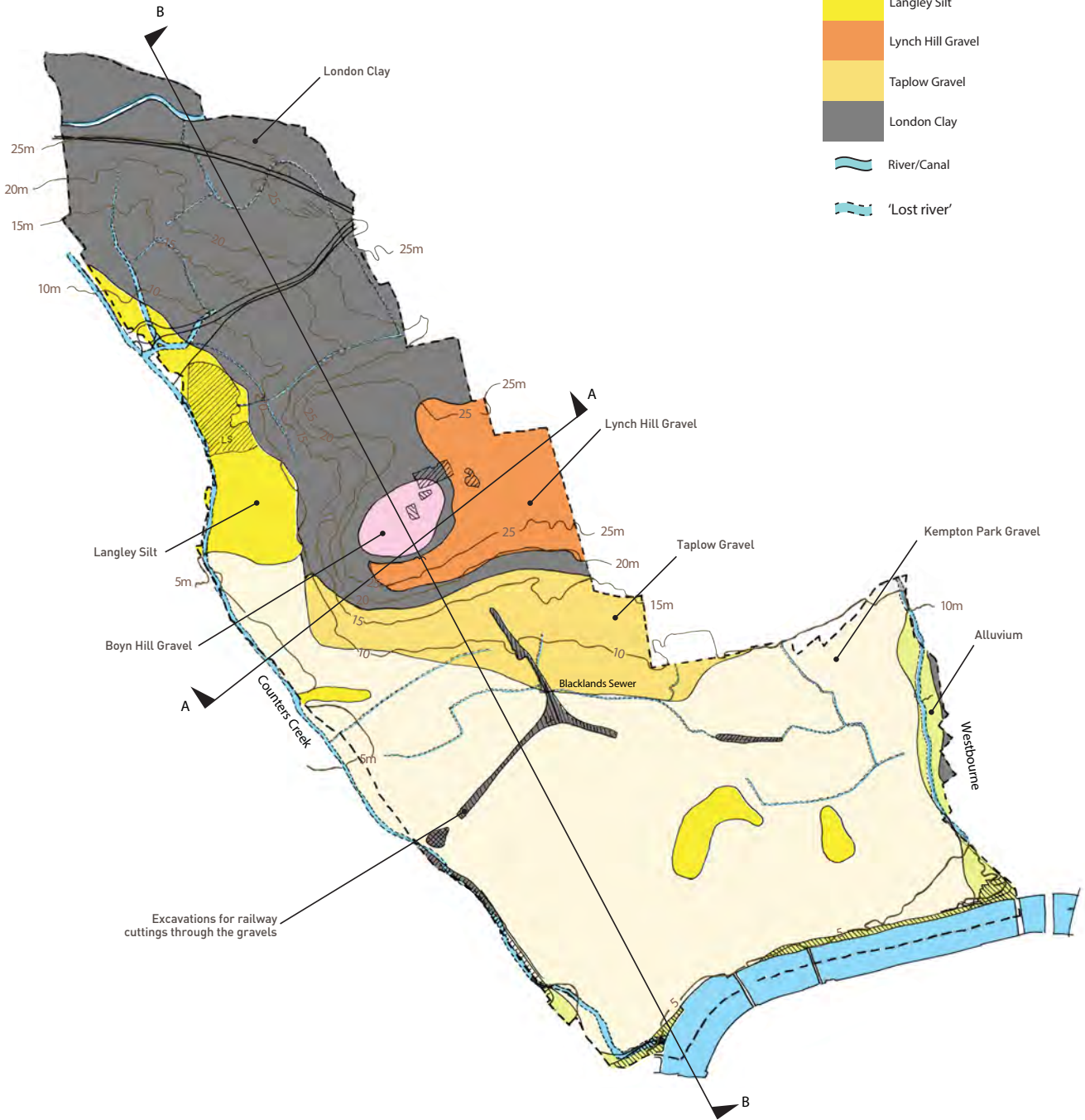



Surface Geology

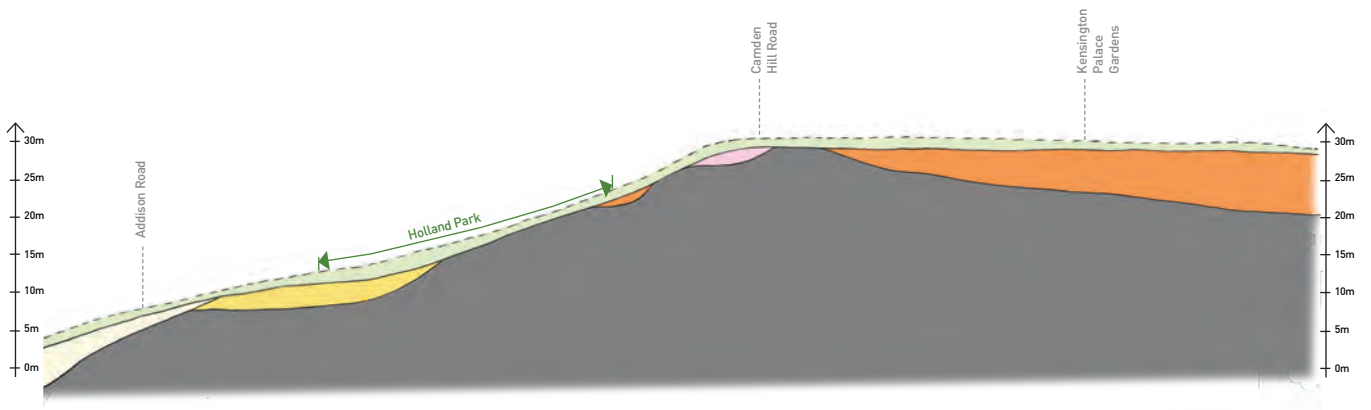
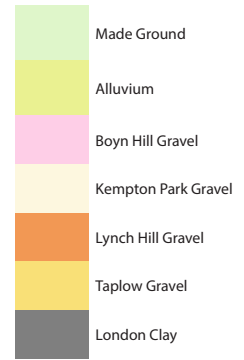

Horizontal scale = 1:2500
Vertical scale = 1:250 at A4

Section A-A

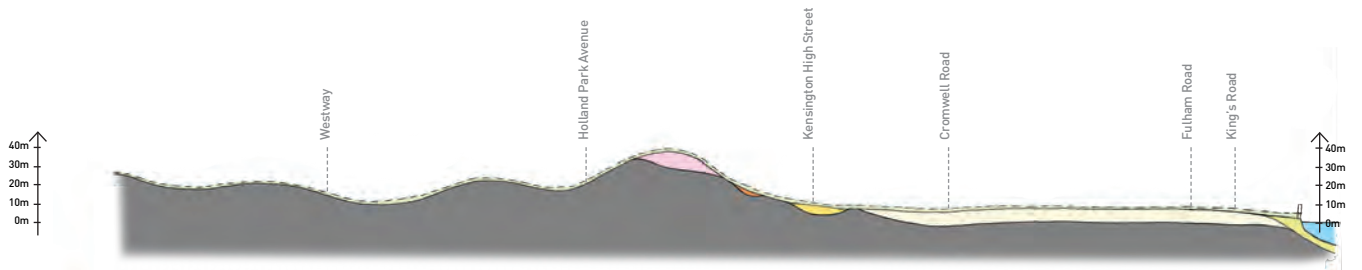

Horizontal scale = 1:2500
Vertical scale = 1:250 at A4

Section B-B

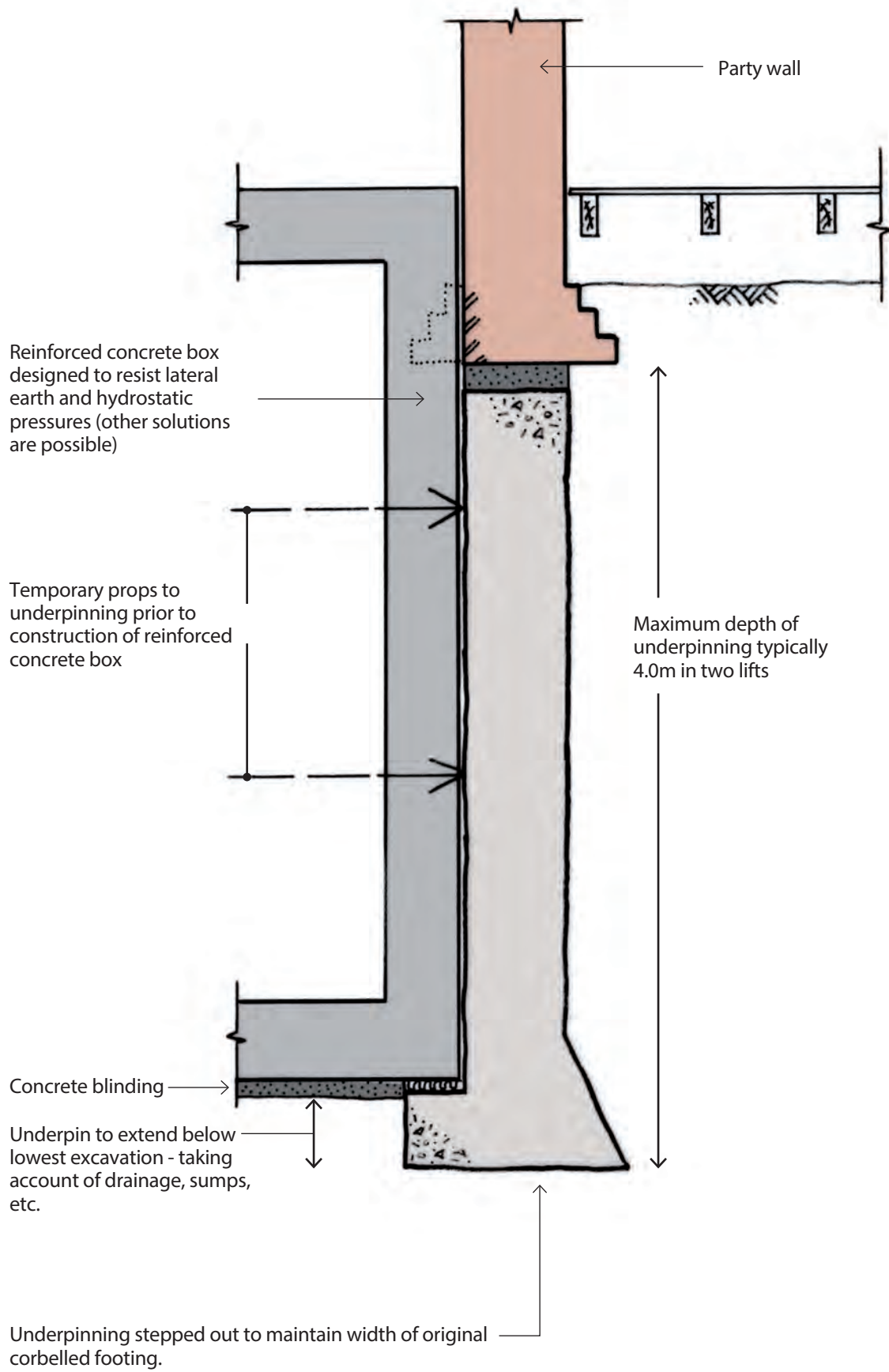

Width of underpinning symetrical with wall over.

Width of underpinning may need to be increased - depending on soil conditions.

ROYAL BOROUGH OF KENSINGTON AND CHELSEA RESIDENTIAL BASEMENT STUDY REPORT	
TYPICAL UNDERPINNING DETAIL TO FORM A BASEMENT	
0954/130	Figure 9 (NTS)
DEC 2012	Alan Baxter

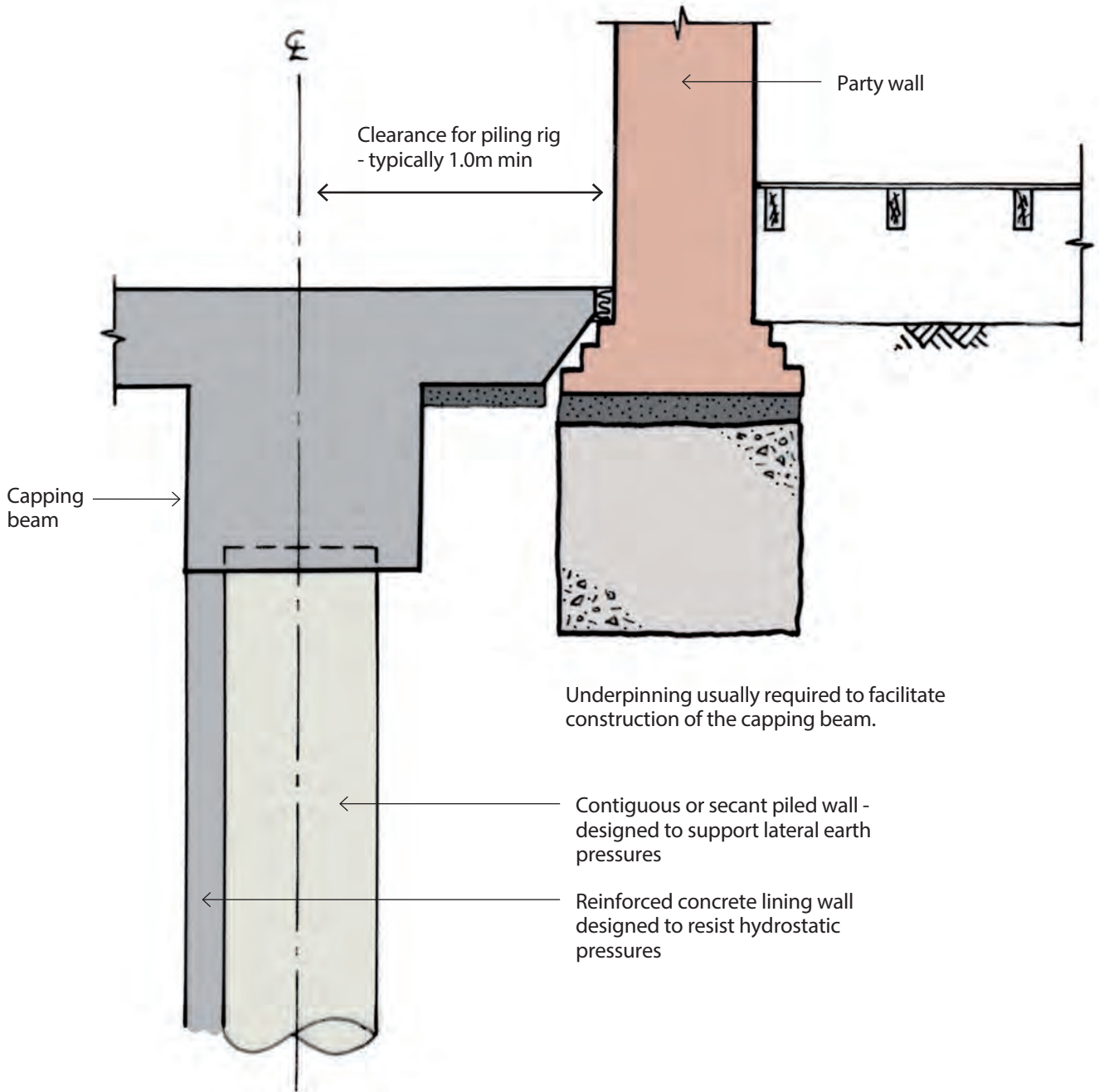

Underpinning usually required to facilitate construction of the capping beam.

Contiguous or secant piled wall - designed to support lateral earth pressures

Reinforced concrete lining wall designed to resist hydrostatic pressures

Step 1 - Excavation in carefully considered sequence

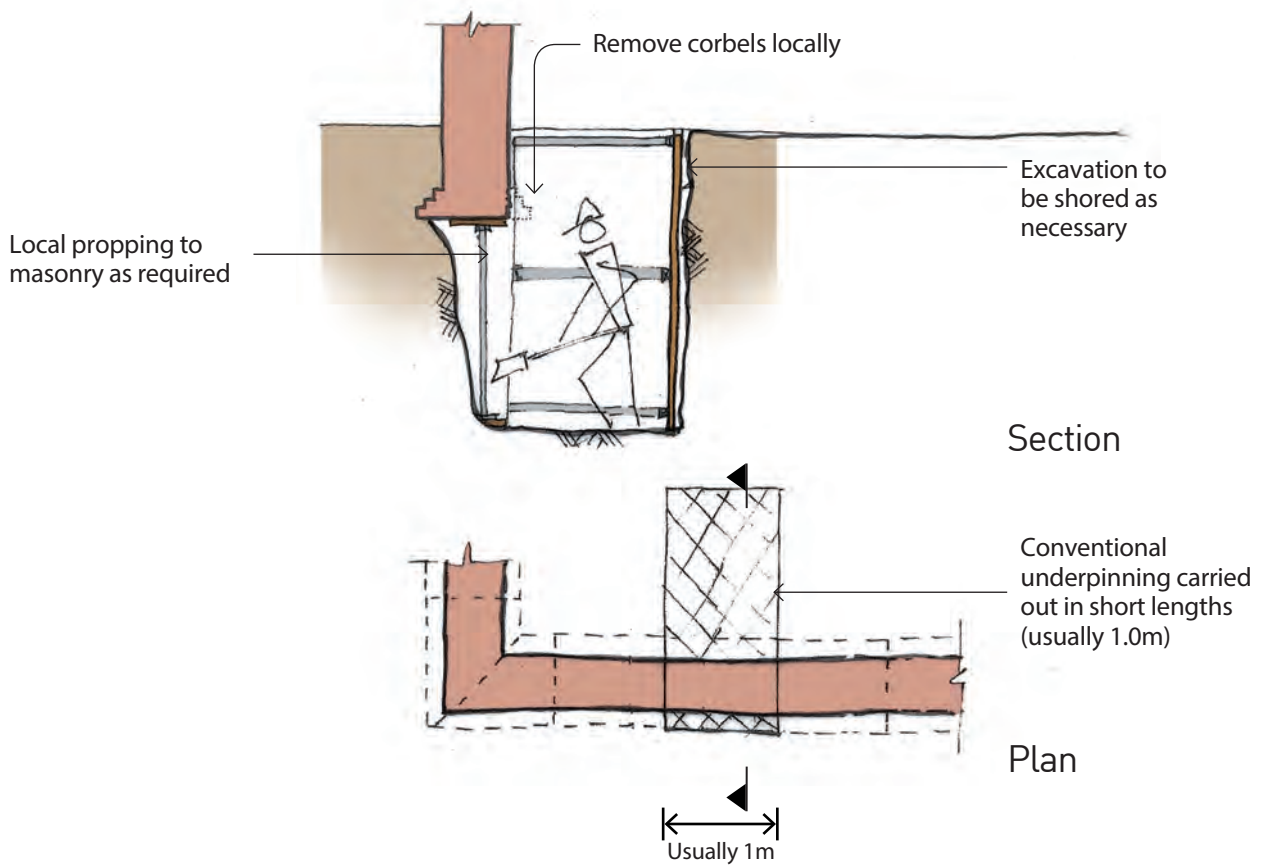

Step 2 - Casting and drypacking of each underpin

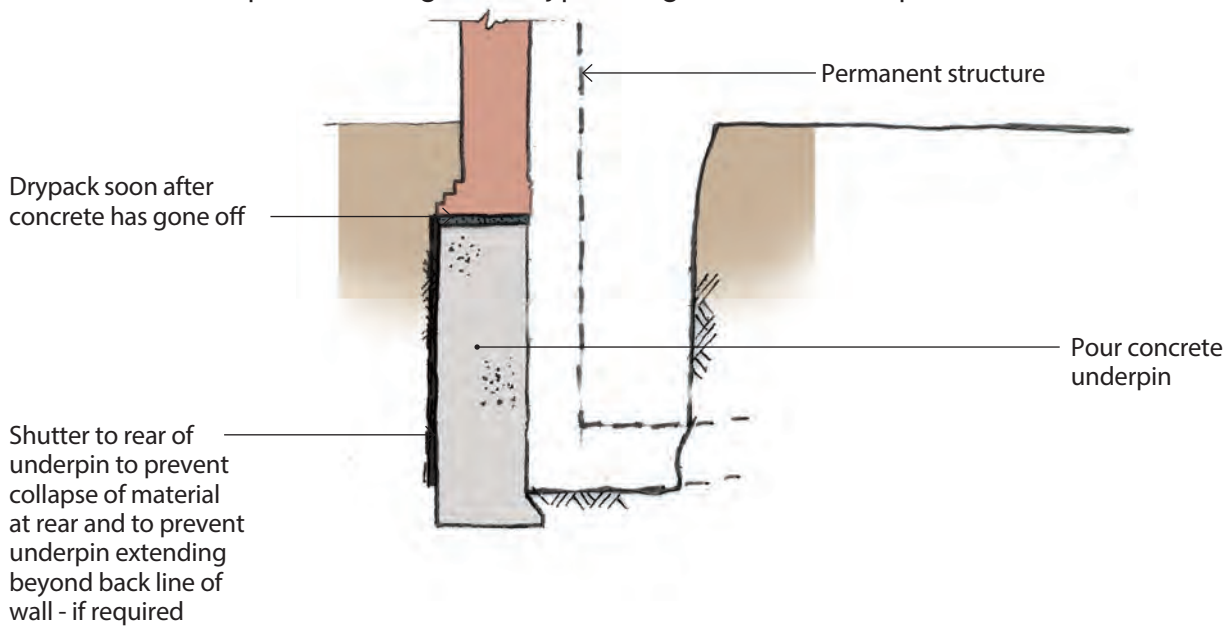

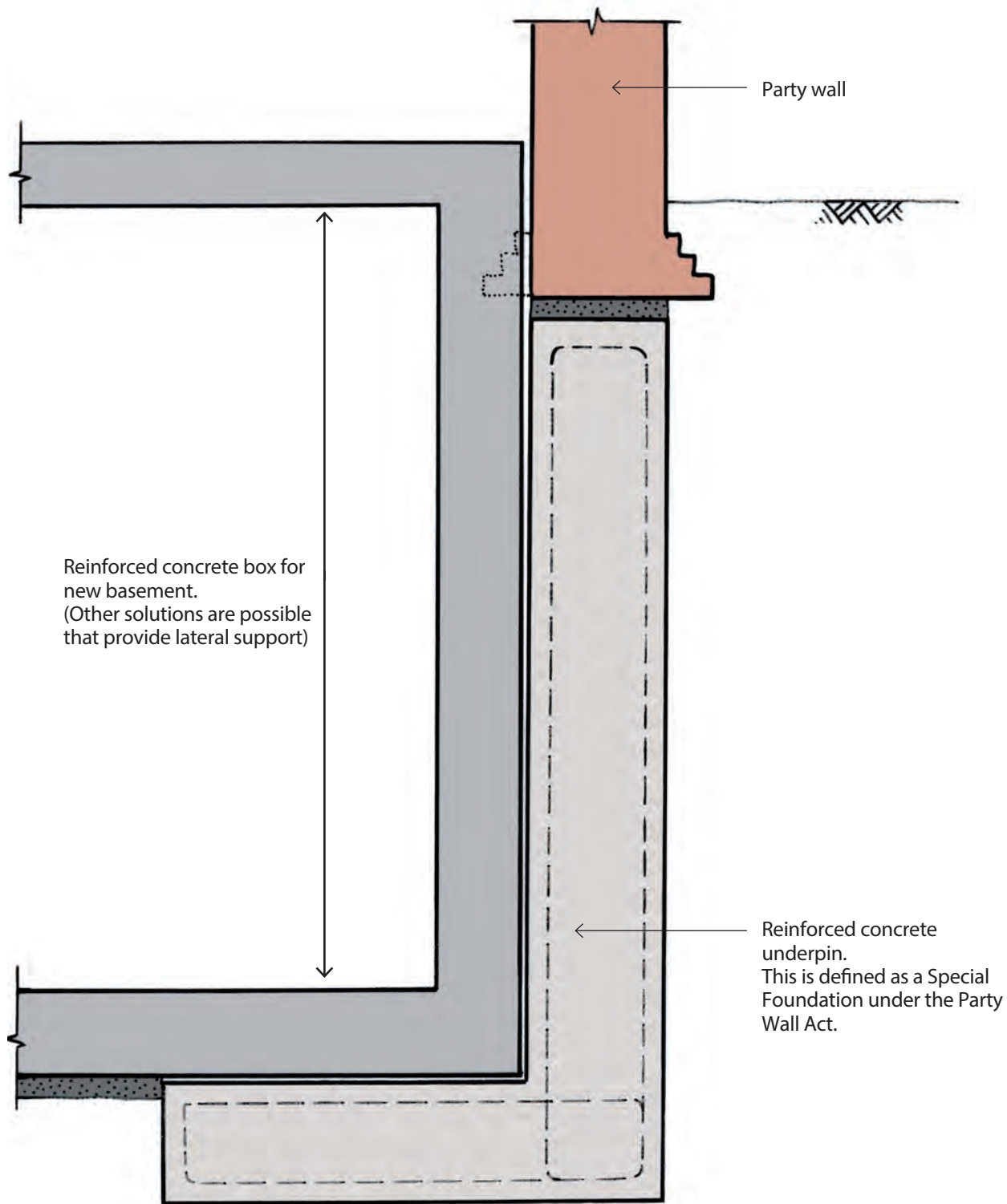

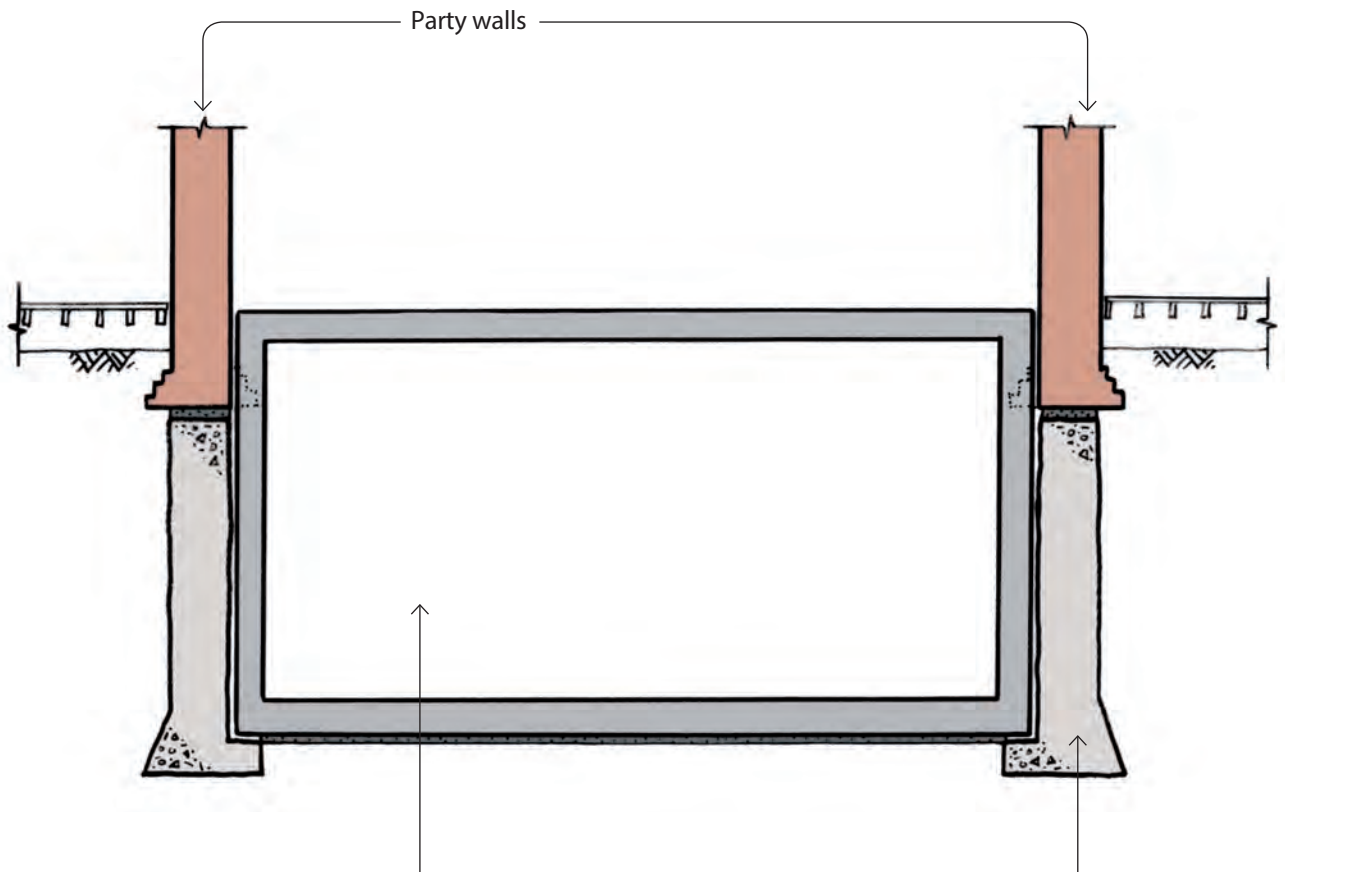

Reinforced concrete box forms new basement and support to internal structure.

Temporary lateral props to the underpins should be provided during construction.

Other permanent solutions that provide lateral support to the underpinned sections are possible.

Underpinning to party walls - width at base should be symmetrical with party wall over.
Note: Width may need to be increased, depending on bearing strata.

Step 1

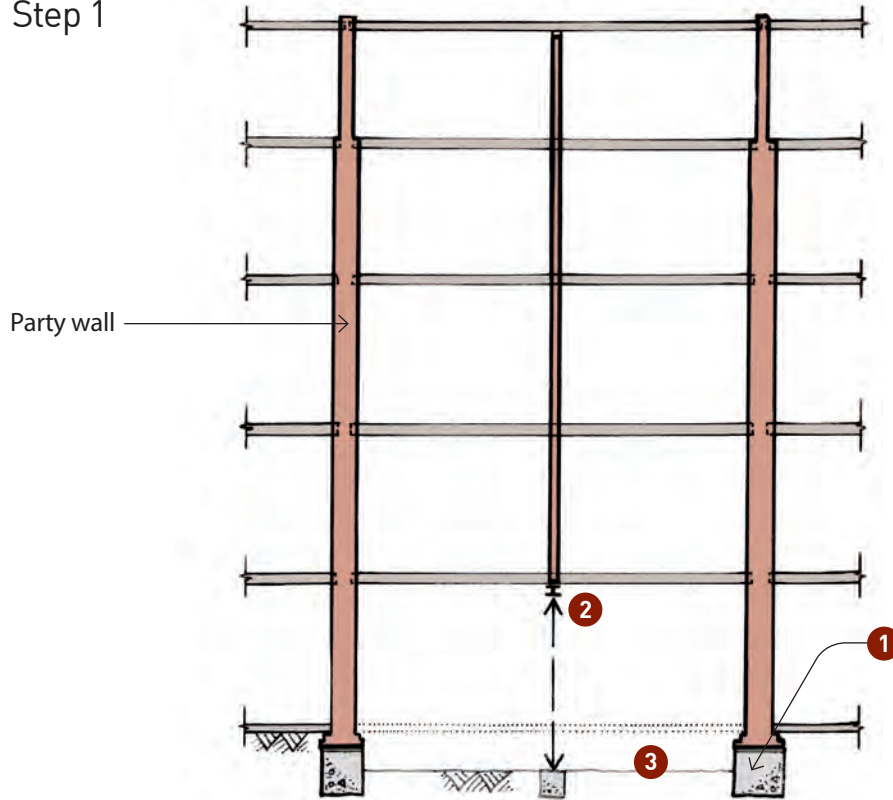

- 1 Locally underpin party walls if required
- 2 Install temporary steel beams and columns on temporary foundations to support internal structure
- 3 Lower the ground floor level if required to provide head room for piling rig - check lateral forces on underpins

Step 2

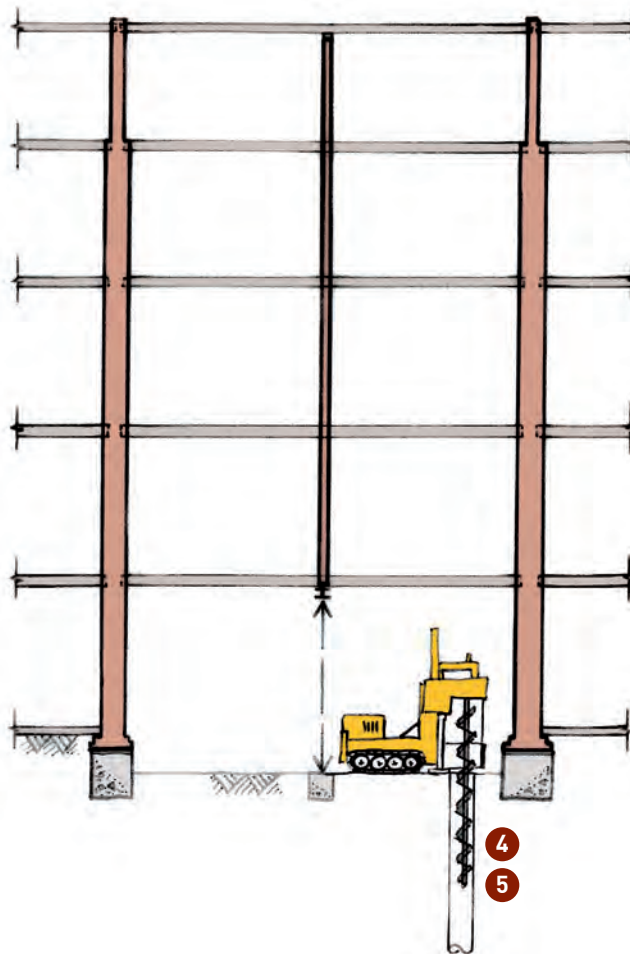

- 4 Install piled perimeter wall using low headroom piling rig
- 5 Proceed with basement construction using top-down or bottom-up construction

ROYAL BOROUGH OF KENSINGTON AND CHELSEA
RESIDENTIAL BASEMENT STUDY REPORT

SEQUENCE OF CONSTRUCTION USING
LOW HEADROOM PILING RIG

0954/130

Figure 14

DEC 2012

Alan Baxter

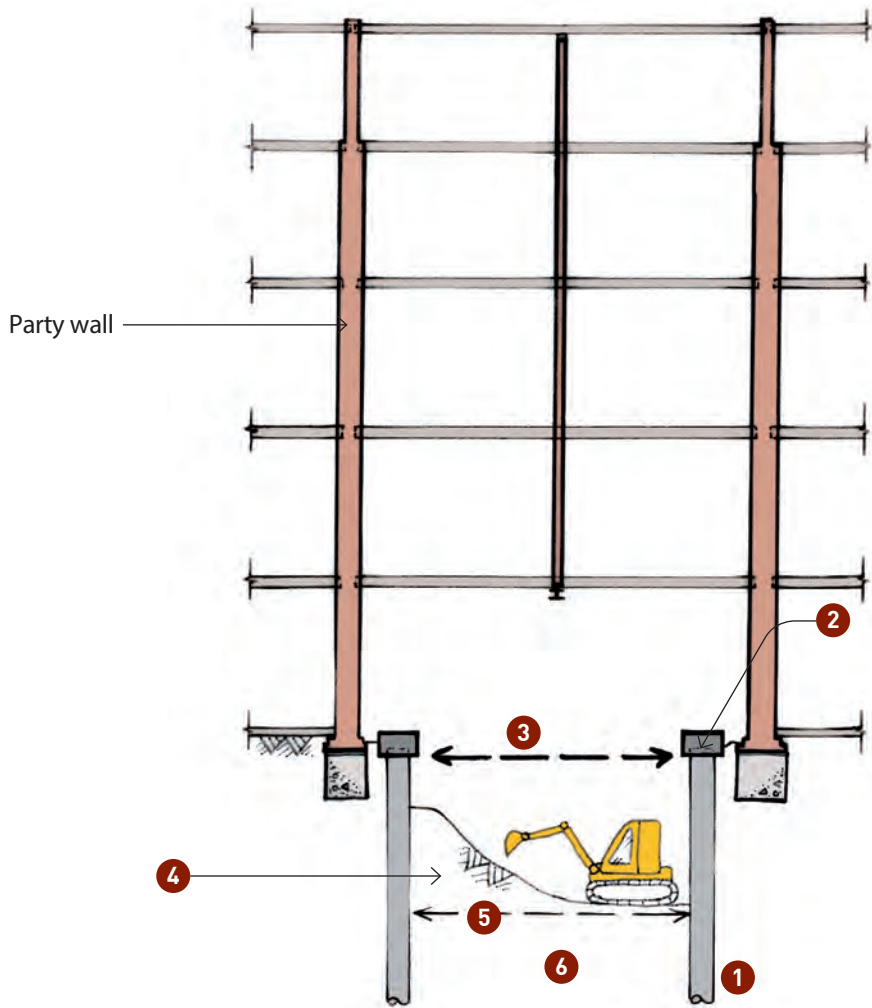

- 1 Install contiguous/secant piled wall
- 2 Cast capping beam
- 3 Install high level props
- 4 Commence excavations
- 5 Install 2nd level of props where required
- 6 Construct basement

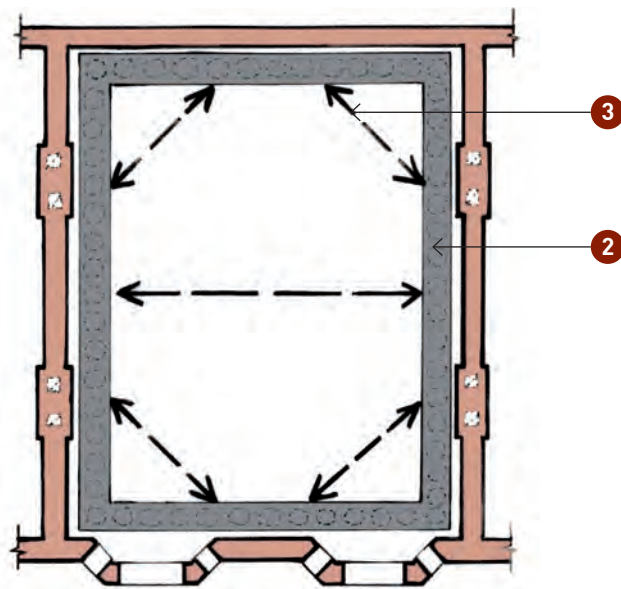

Plan

a.

Masonry walls constructed using lime mortar can adjust to small movements without structural cracking

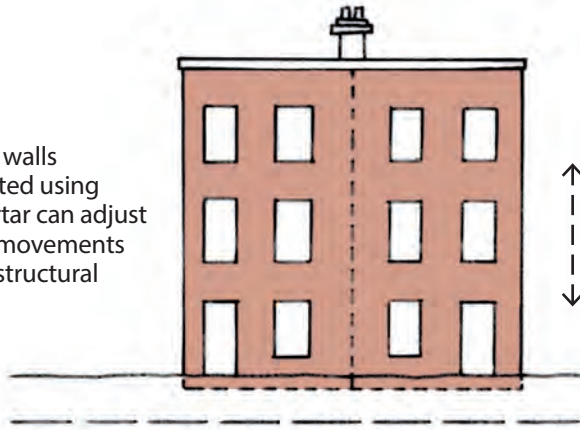

↑
- - -
↓
Semi-detached or terraced houses.
No significant differential movements due to seasonal movements

↕
Zone of subsoil which may be subject to seasonal movements

b.

Differential movements are increased which may cause cracking to the adjacent property

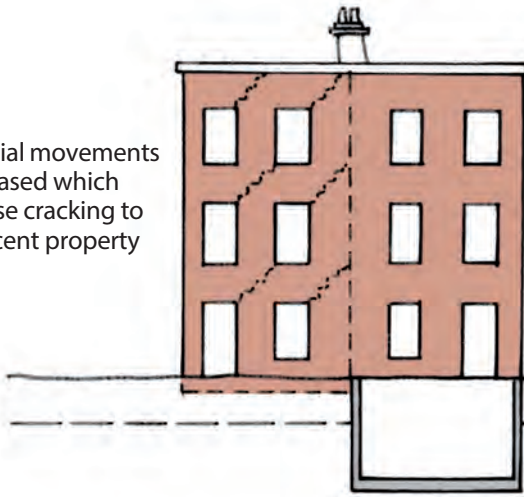

Constructing a basement means one house is founded on ground which is more stable

↕
Zone of subsoil which may be subject to seasonal movements

↕
Stable ground

c.

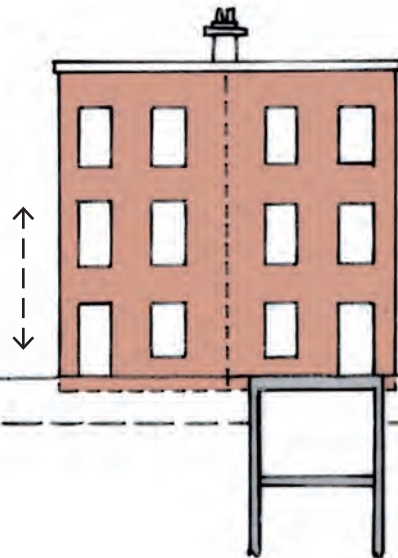

Basement formed using internal piled walls without deep underpinning, within the load bearing walls. The original house can continue to move - this reduces the likelihood of differential movement problems

↕
Zone of subsoil which may be subject to seasonal movements

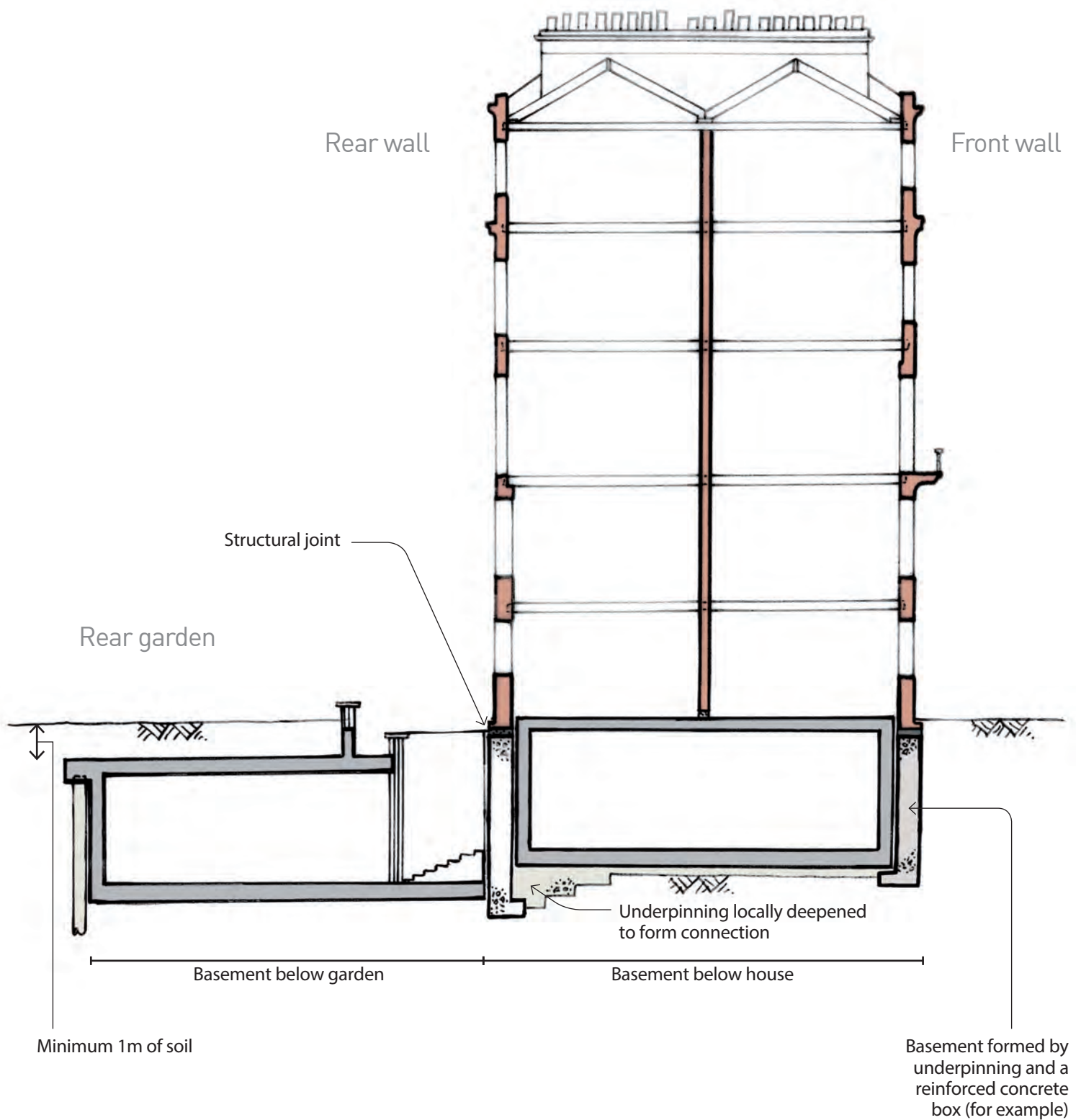

Bottom up construction

Step 1

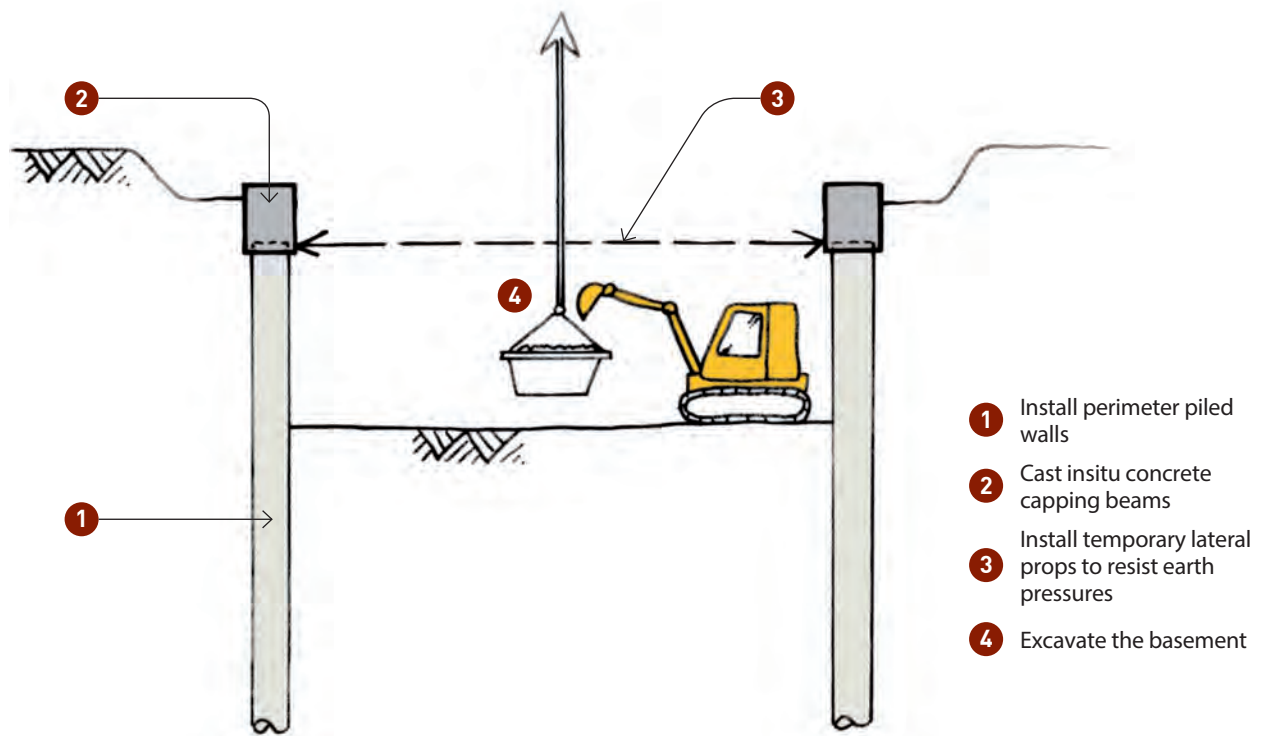

Step 2

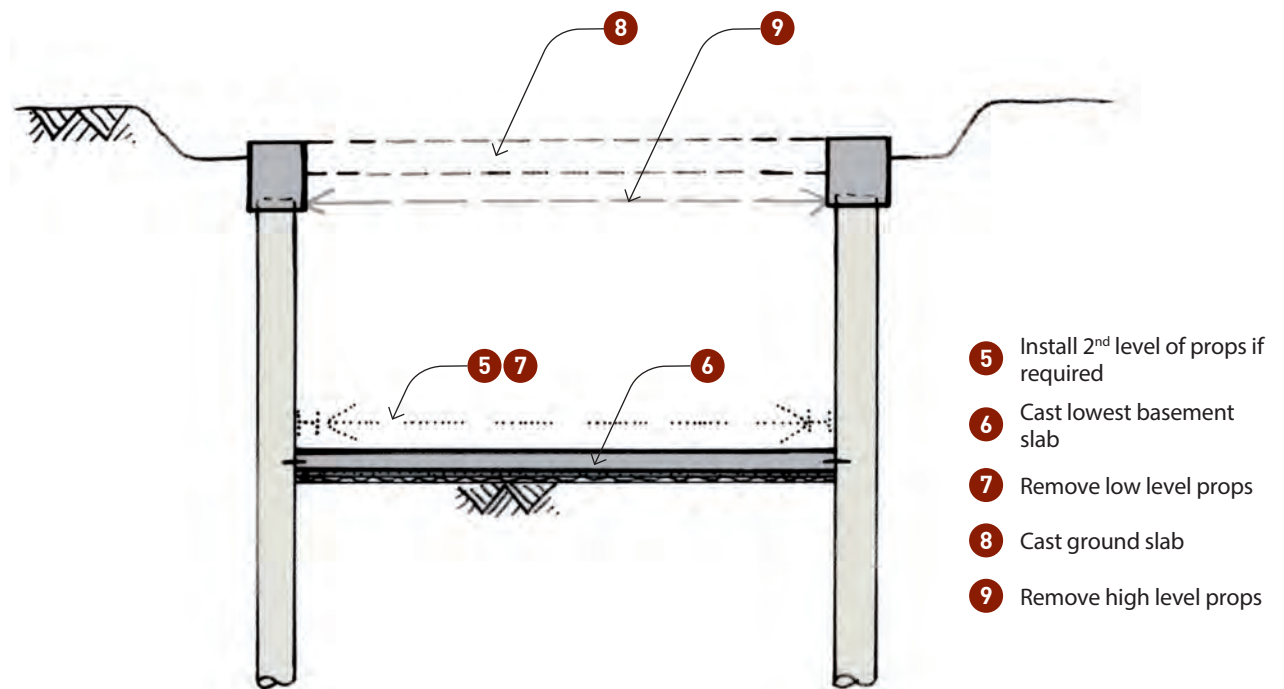

Top down construction

Step 1

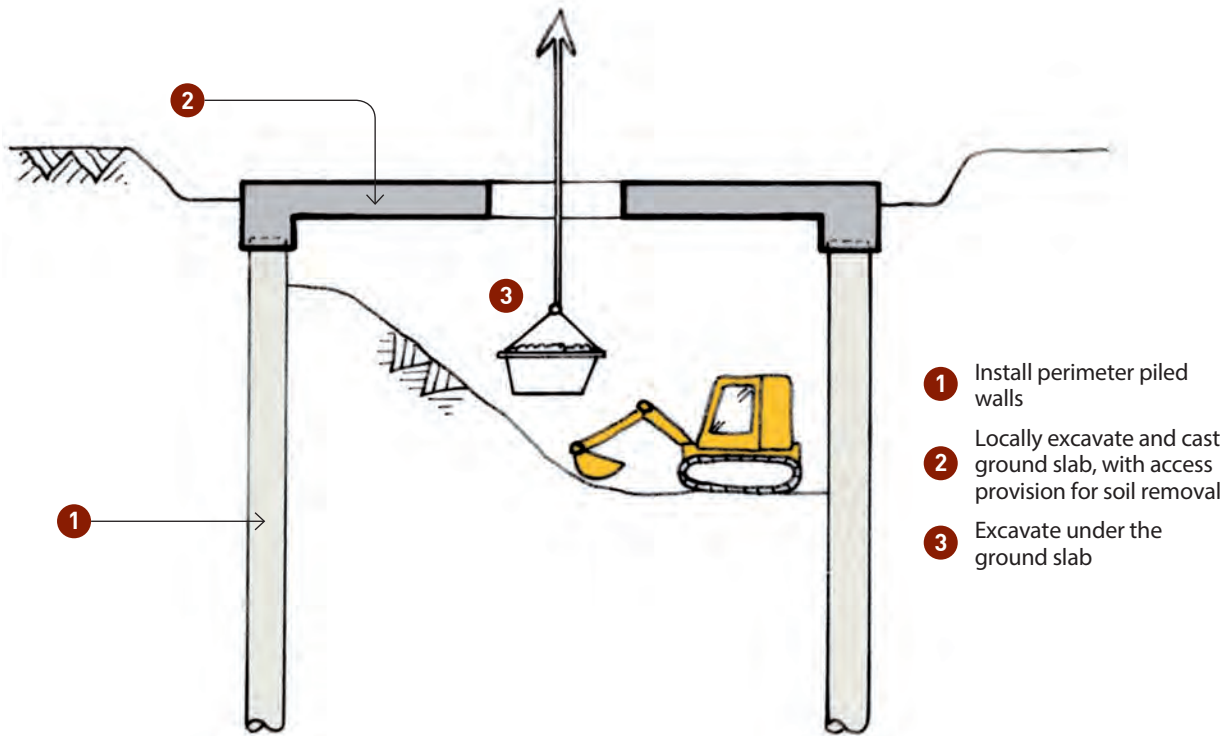

Step 2

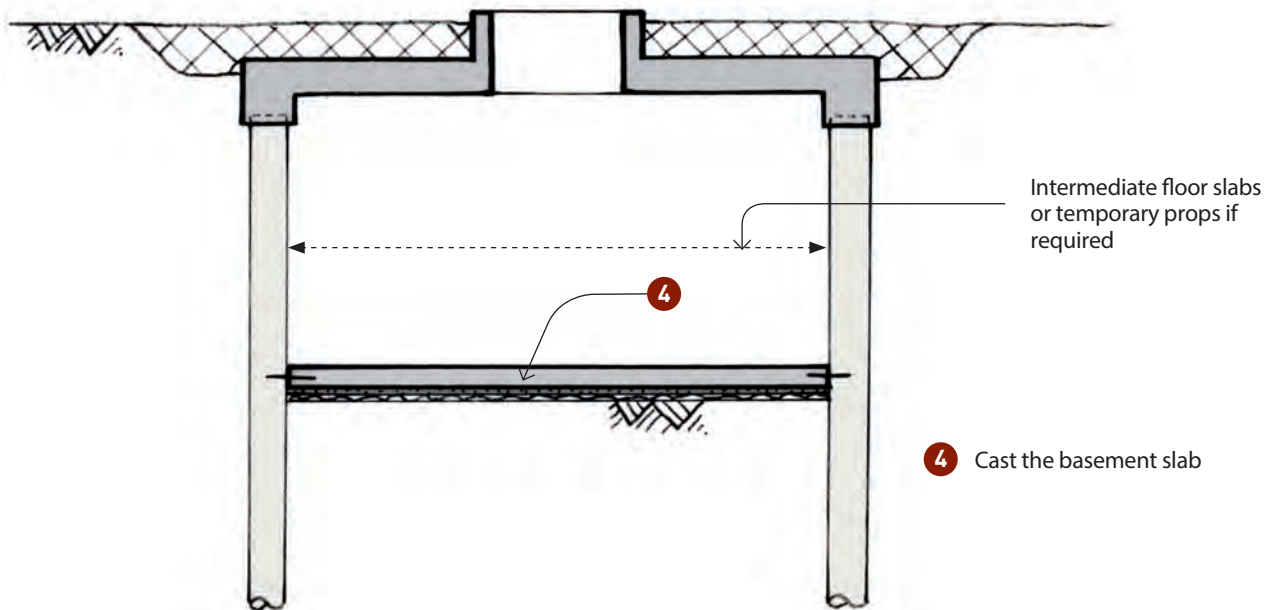

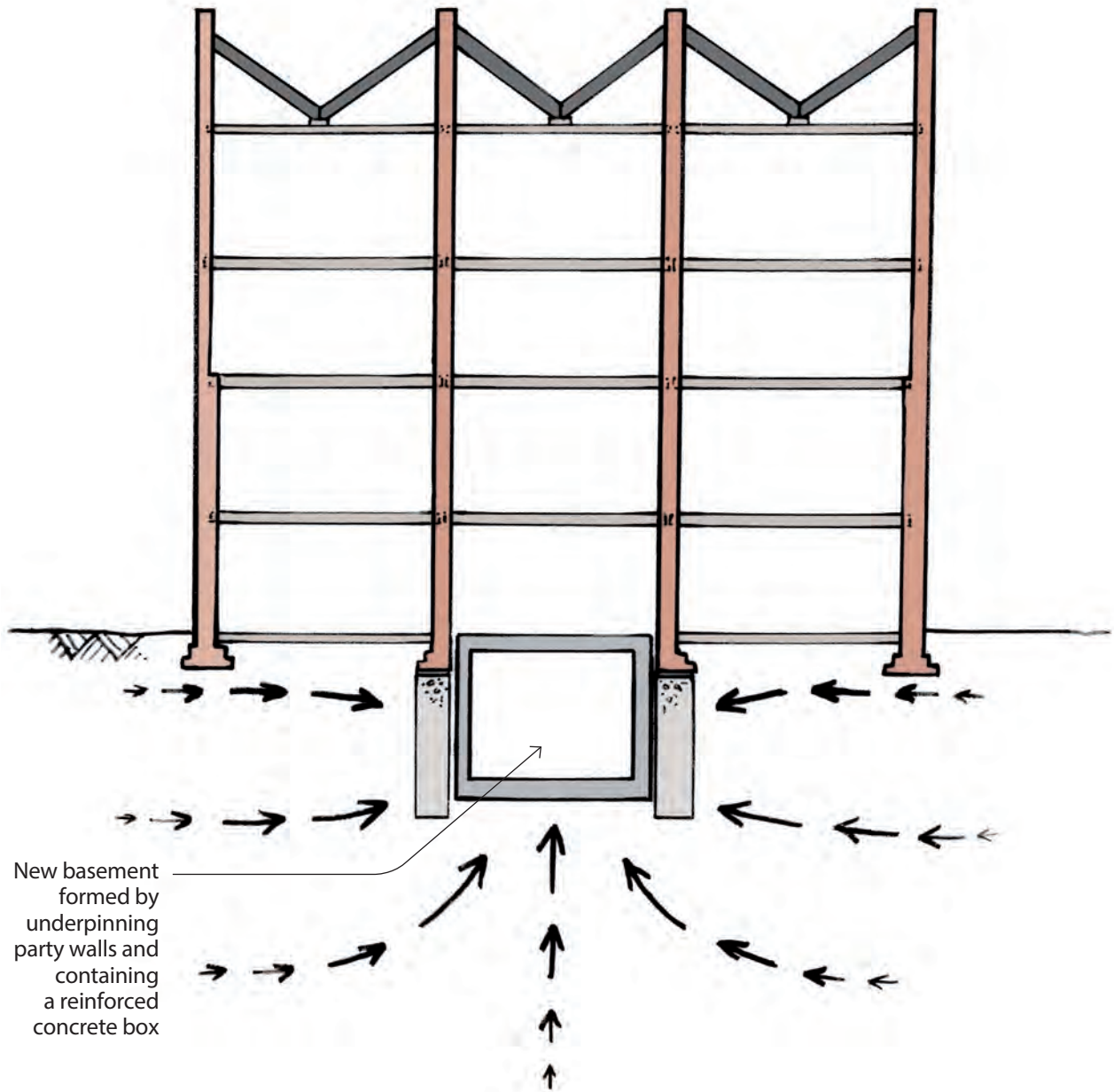

New basement formed by underpinning party walls and containing a reinforced concrete box

As the basement is excavated, the ground tends to move towards the excavation. This causes lateral pressures on the sides of the underpinning and an uplift on the basement.

ROYAL BOROUGH OF KENSINGTON AND CHELSEA RESIDENTIAL BASEMENT STUDY REPORT	
INDICATIVE GROUND MOVEMENTS DUE TO BASEMENT EXCAVATION	
0954/130	Figure 19
DEC 2012	Alan Baxter

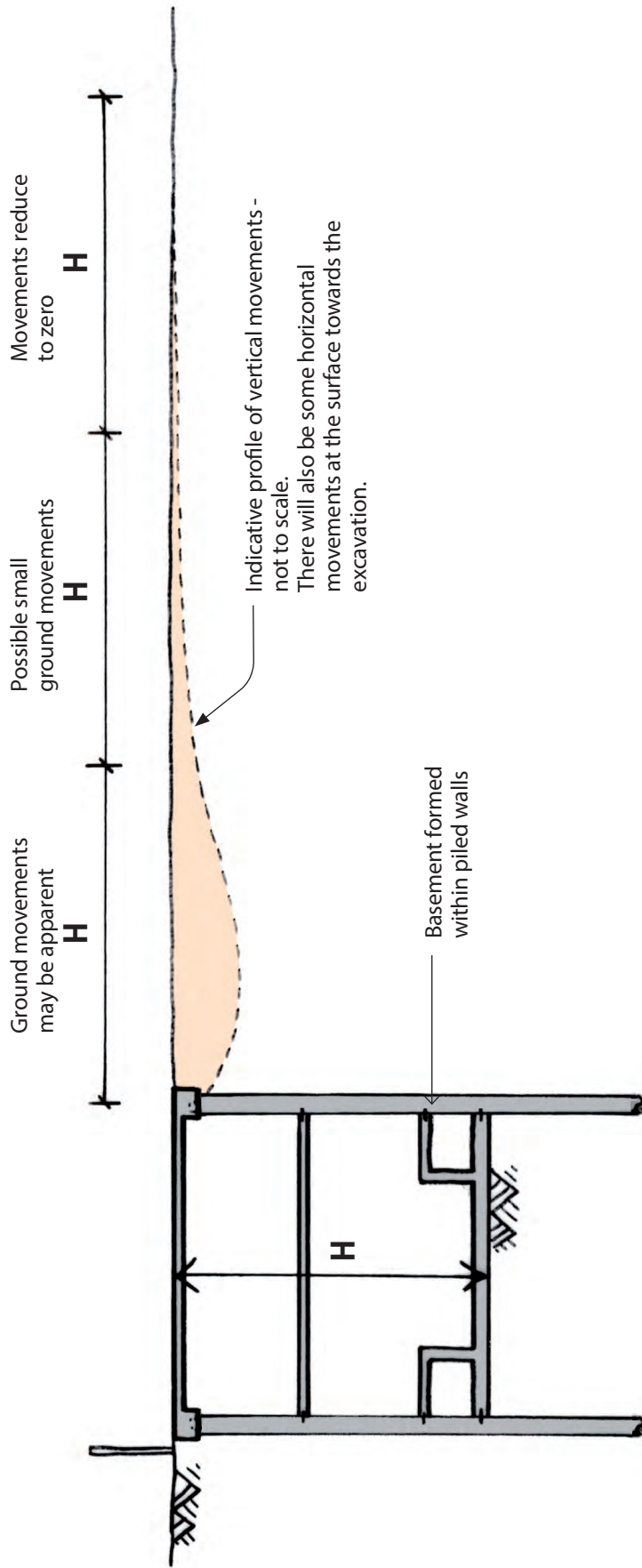

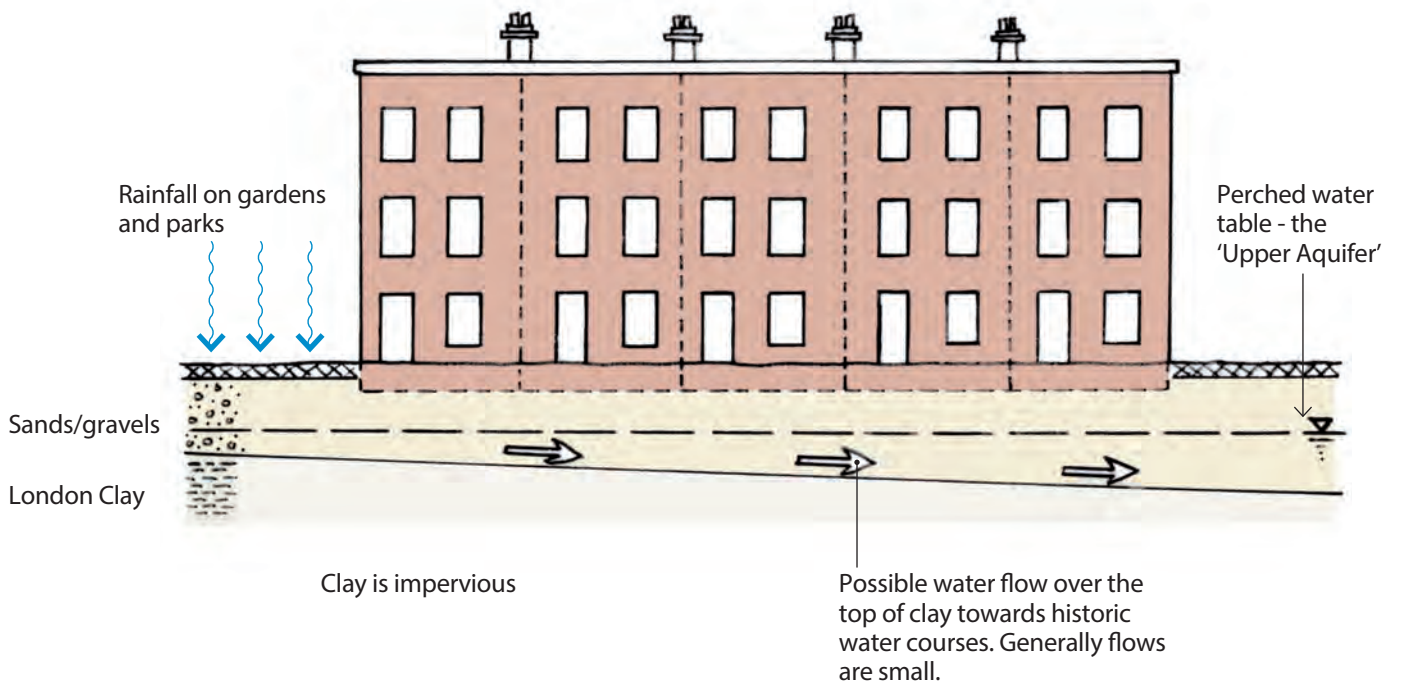

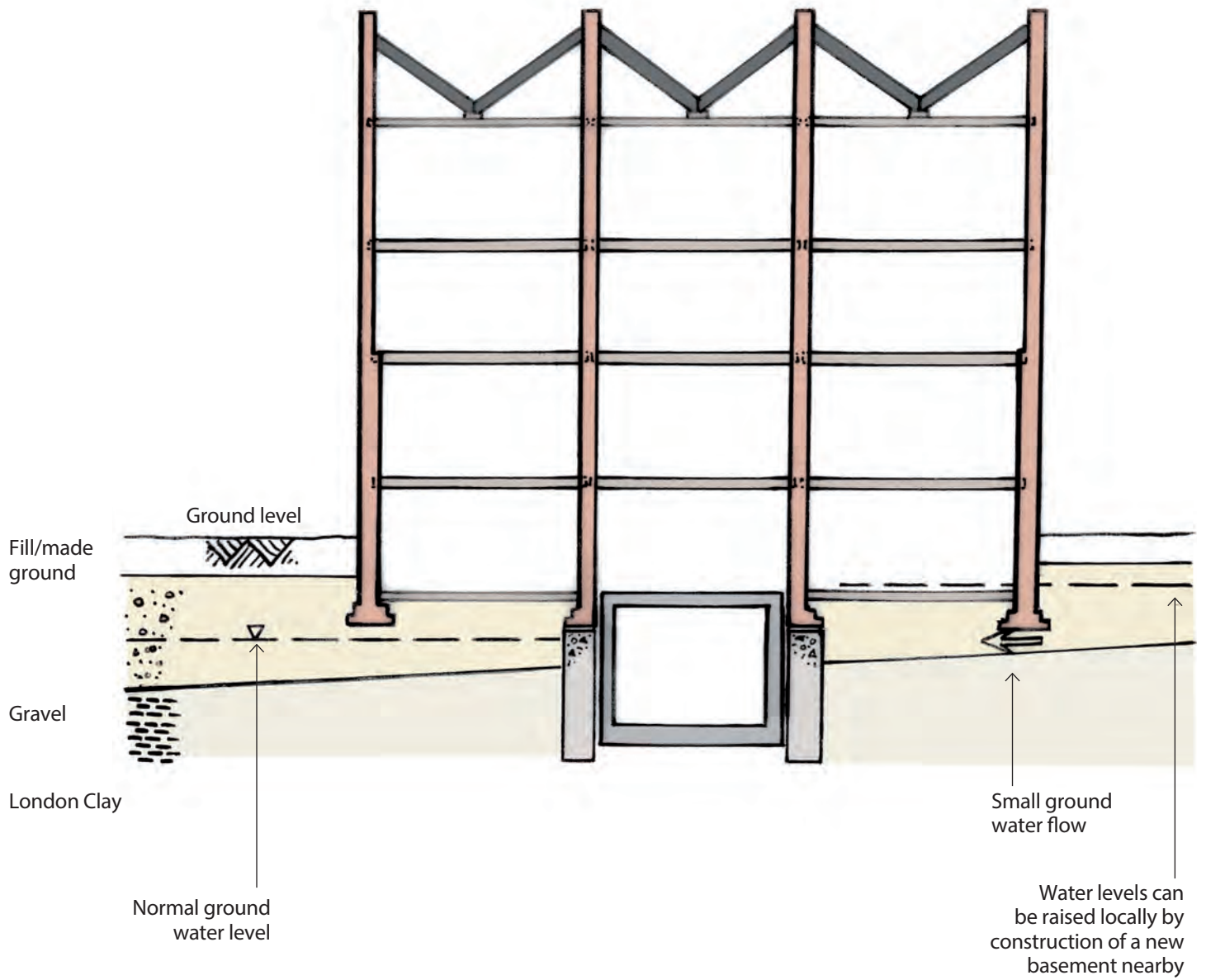

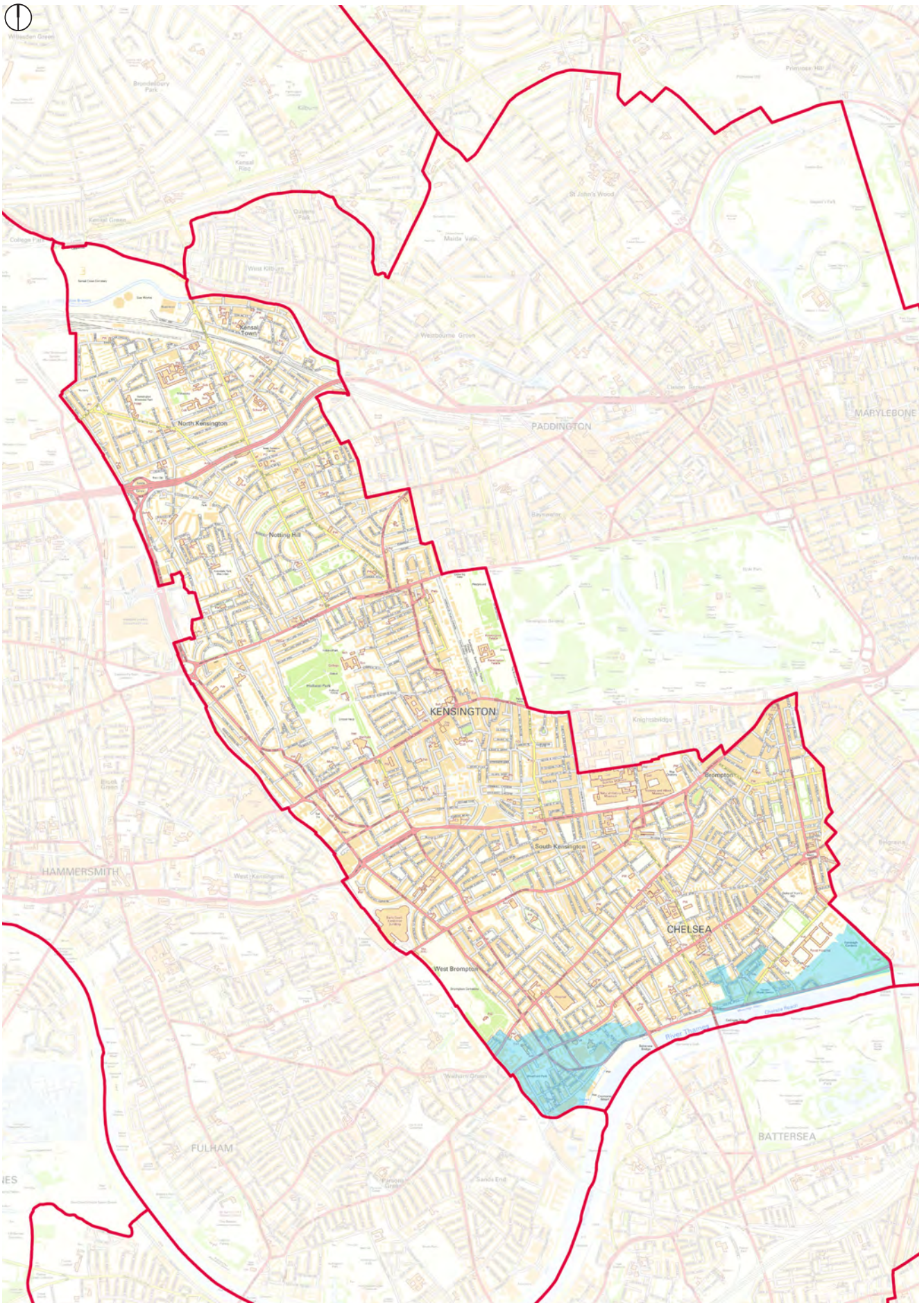

Note: Indicative only, and for initial guidance purposes

Areas at risk of flooding

Reproduced from RBKC Strategic Flood Risk Assessment

ROYAL BOROUGH OF KENSINGTON AND CHELSEA
RESIDENTIAL BASEMENT STUDY REPORT

OVERTOPPING INUNDATION

0954/130

Figure 23

DEC 2012

Alan Baxter

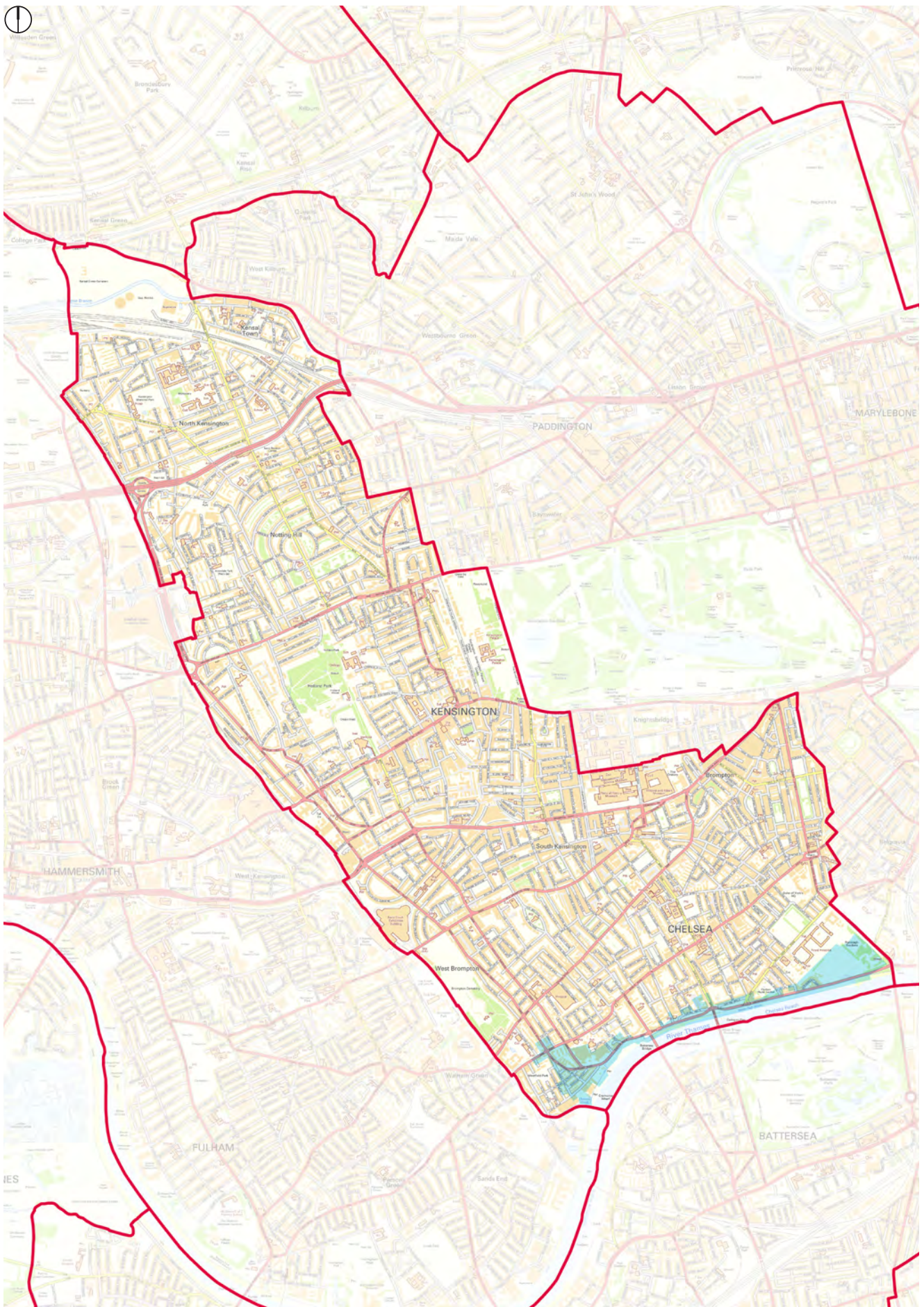

Note: Indicative only, and for initial guidance purposes

 Areas at risk of flooding

Reproduced from RBKC Strategic Flood Risk Assessment

ROYAL BOROUGH OF KENSINGTON AND CHELSEA
RESIDENTIAL BASEMENT STUDY REPORT

BREACH INUNDATION

0954/130

Figure 24

DEC 2012

Alan Baxter

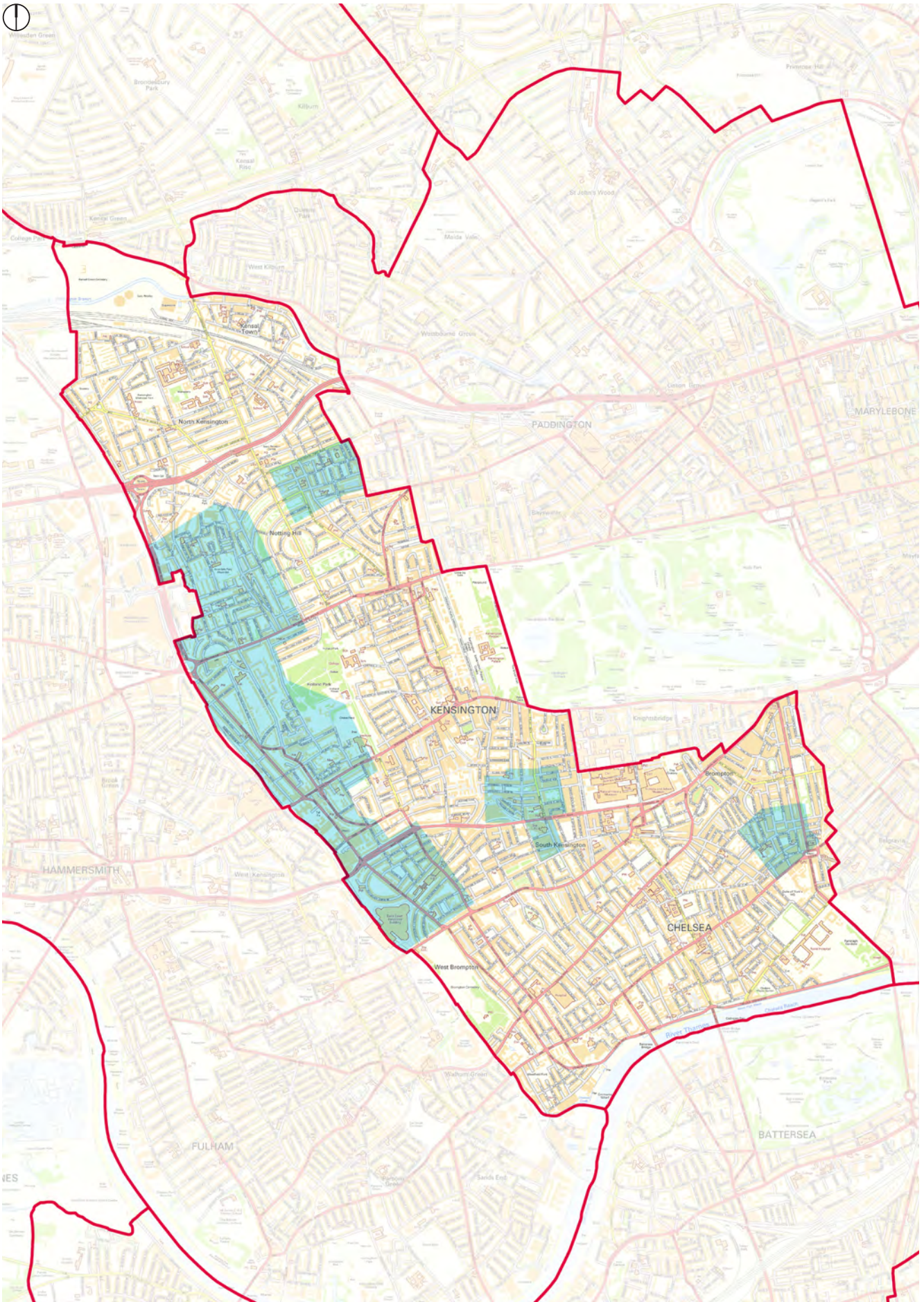

Note: Indicative only, and for initial guidance purposes

Areas which historically have had increased risk of surface water flooding

Reproduced from RBKC Draft Surface Water Management Plan

ROYAL BOROUGH OF KENSINGTON AND CHELSEA
RESIDENTIAL BASEMENT STUDY REPORT

LOCAL SURFACE WATER FLOOD
RISK ZONES

0954/130

Figure 25

DEC 2012

Alan Baxter

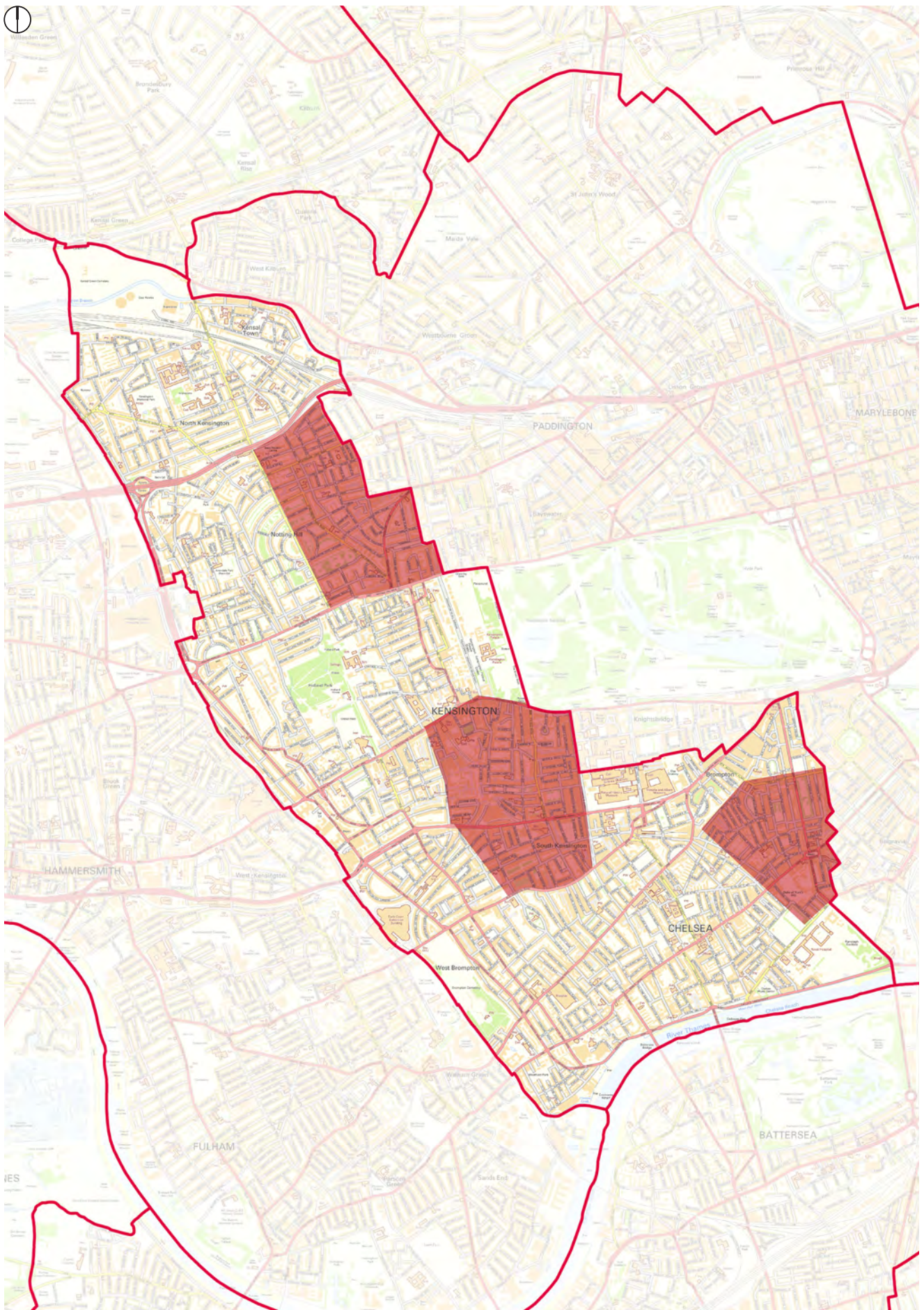

Note: Indicative only, and for initial guidance purposes

Areas where there is a significant increased risk of the drains being surcharged during periods of heavy rainfall

Reproduced from RBKC Draft Surface Water Management Plan

ROYAL BOROUGH OF KENSINGTON AND CHELSEA
RESIDENTIAL BASEMENT STUDY REPORT

CRITICAL DRAINAGE AREAS

0954/130

Figure 26

DEC 2012

Alan Baxter

Appendix B

Questions and Answers

Question 1

Does a basement extension at one end of a terrace “anchor” the terrace which otherwise would have “floated” as a single entity, thereby contributing to structural damage?

Answer

The construction of a basement under a single property of a terrace results in a discontinuity of the foundations of that terrace. It does not matter if the basement is at the end of the terrace or in the middle of it. The consequence of such basement construction very much depends on the subsoil conditions, the nature of the structure of the terrace and the history of movements of the buildings in the terrace. When the terrace has shallow foundations in fill or on clay, a basement constructed by underpinning party walls will act as an “anchor” in that it will prevent the property with the new basement from moving together with the rest of the terrace. This could generate problems for the adjoining properties and the terrace as a whole. There are other ways of creating a basement in this situation which do not “anchor” the basemented building and allow the terrace to continue to move. (see – Clause 8.6 (j) of the report.)

Question 2

Are there different risks associated with the construction of basement extensions for different property types i.e. detached and terraced properties?

Answer

Practically every basement project has a different set of risks or issues which need to be considered in the design process. This is a prime reason why generic basement solutions should not be accepted (see 13.2.2). The designers need to identify what the issues are and take account of them in their proposals. Generally if a basement is to be constructed under or next to a detached house in its own grounds this will involve less risk to adjacent properties than in a case where a building is attached on one or more sides. The closer the basement is to adjacent properties, the more factors there are that will need to be considered. The engineering issues are listed in section 8.6 of the report. The greatest risks to adjoining or adjacent properties arise when those commissioning, designing and constructing a basement do not understand the engineering issues set out in this report, or follow good practice.

Question 3

What is the impact between subterranean development and properties which do not directly abut the basement development/share a party wall?

Answer

This question does not have a simple answer. A number of factors come into play including the distance between the basement and the nearby properties, the ground conditions, the depth of the basement, the method of construction and temporary works. All of these factors are set out and explained in the report. If the basement depth is such that it displaces or alters groundwater flows, in some instances where surrounding buildings have built space close to the Upper Aquifer water table, these spaces could be affected by locally raised ground water levels even if they do not immediately abut the new basement space.

Question 4

Does the building of larger basement extensions have greater risks in terms of structural stability and all types of flooding. In principle, can double (or greater) extensions be created without having a detrimental impact upon groundwater and structural stability? Do multi-storey basements have particular implications with structural stability and groundwater?

Answer

If a basement is wholly above the level of groundwater, then it should have very little if any effect on the groundwater.

Basements which extend below the water table need further consideration and checking, but unless there are specific site circumstances or the existing water table is close to the floor level of adjacent buildings an individual basement is unlikely to change the groundwater regime. Where there are several basements close together their cumulative effect could alter the groundwater levels (see clause 9.4.9). When a basement extends below the water table, the effect on the water if any is the same whether it extends 1m or 5m or more below the water.

Lateral ground pressures increase with depth so the deeper the basement, the greater the care required in both the temporary and permanent design and construction. Generally, overall, ground movements increase with basement depth, assuming that the design and temporary works are properly addressed. Deeper basements need larger and more robust structural walls and temporary works.

Question 5

Is there a direct relationship between the depth of the work, proximity of neighbouring properties and risk of structural instability? Could an approach be justified which resists basement extensions where the depth of the deepest engineering works lies within a given distance and angle from an adjoining property.

Answer

Deeper basements very close to neighbouring properties have an increased potential to cause greater movements. However, by adopting good practice and techniques discussed in the report, it is feasible to design and construct relatively deep basements close to neighbouring properties. It is not appropriate to define an angle and distance from one adjoining property – this would prevent practically all basements in terraced or semi-detached properties.

Question 6

Does the mass of a building that is subject to underground extension have an impact upon possible structural damage to adjoining buildings? Might, for instance, a four storey building settle more than one which is two storeys?

Answer

Foundations of buildings are generally sized to limit the bearing pressures on the ground – so as a rule a four storey building will have wider foundations than a two storey building.

The process of underpinning can cause settlement but this settlement does not vary significantly according to the height of the building. The structural condition of the wall, ground conditions, ground water level and the degree of care taken during construction are all important factors. They are independent of the height of the building to be underpinned.

Question 7

Are there circumstances where a basement beneath an existing building (underpinning) may be more appropriate than that beneath a garden (cut and cover)?

Answer

Constructing a basement in a garden should have fewer engineering challenges than constructing one under a house. It should result in less overall movements for the house and be quicker and more cost effective to build. Where the basement abuts the house the challenges are similar as if it was being built under it. However, where there are large trees, a basement in a garden may not be feasible, so it may be more appropriate to construct it under the house.

Building basements under gardens may also have more impact on the character of the area and the ability of the garden to support major trees and shrubs, and may contribute to increased run off of rainwater with the subsequent impact on the drainage systems.

Question 8

Does the method of construction have implications on risk, be this concerning structural stability or upon noise and vibration?

Answer

The method and sequence of construction is probably the most important aspect of basement construction. When problems such as movements of adjacent properties arise, it is nearly always because either design or the method of construction is flawed, or there is a lack of adequate temporary works. There is a close relationship between the design of a basement and the method of construction. This is sometimes not adequately understood or reflected in the way basement projects are procured.

It is essential that both the design team and the contractors are carefully selected, that they work closely together and that they can demonstrate a track record of design and construction of basements.

Question 9

What is the long term risk of structural stability, following years of settlement?

Answer

The major risk to structural stability occurs during the construction process. When the basement construction is complete there may be small ongoing movements which continue for many months but often these are imperceptible. The exception to this is where the adjacent buildings are founded on shallow foundations in a material which is subject to seasonal variation. In such cases the design and construction needs to be arranged to take account of this as described generally in this report (see clauses 9.2.5, 9.3.5.2 and 9.3.7)

Question 10

Are there particular risks associated to listed buildings, many of which are properties which have shallow foundations? If there is a greater risk to such buildings should this be mitigated by "exclusion zones" of basement development from listed structures?

Answer

From a structural engineering viewpoint there is little difference in risk between a listed and unlisted building. However one difference is that some listed buildings may be more likely to have delicate or special finishes which might be more susceptible to cracking as a result of ground movements and be more difficult to repair. Structurally older buildings tend to be more able to accommodate ground movements than more modern brittle structures. The objection to basements under listed buildings primarily relates to how a building is used rather than any particular structural risk.

Question 11

Will these conclusions be dependent on the particular characteristics of the part of the Borough in which the property lies?

Answer

The decisions on the approach to designing and constructing a basement do vary with the different characteristics of the part of the Borough. Practically every project will have a different set of parameters which need to be taken into account in the proposals. Again, this is why a site specific design and approach is needed.

The north of the Borough has clay subsoil close to the surface. To the south the subsurface material is gravel. These differing ground conditions need a different design approach. The area around Notting Hill has more complex ground conditions with ground water close to the surface in places. Basements proposed in this area need special consideration (see clauses 5.6 and 6.3).

Question 12

Are the requirements of what the Council expect within a Construction Management Statement adequate (as set out in the Subterranean SPD). This should include considering:

- *How does one pick up localised springs which could cause flooding? Will the drilling of a single borehole be adequate?*
- *The Council currently requires self certification by a Chartered Civil Engineer or Structural Engineer. Are there qualifications that should be demanded of the constructor, or expertise that the constructor should bring in, or some form of monitoring that should be done, to ensure good construction methods are followed?*

Answer

This report includes a section on the information which should be provided with a Planning Application. The report also indicates general areas in the Borough where the risk of localised springs may occur. In these areas the Developers should seek additional specialist advice in relation to groundwater and carry out more detailed site investigations. As a minimum, this would probably require at least two boreholes and monitoring of groundwater levels over a period of time. (Note: This report is not intended as a definitive guide to areas which have increased risks of ground water issues – it is intended to illustrate principles. The developer should make his own enquiries to establish site specific risks.)

Chartered Engineers will have experience of a wide range of structures. In addition to being Chartered, the Engineer should also be able to demonstrate a successful track record in the design of basements of a similar size and nature to that proposed.

Similarly the Contractors should also be able to demonstrate a track record of successful projects.

Appendix C

Brief Case Studies

Case Study 1

New basement under rear garden of a terraced house with deep foundations on London Clay

Project Description

The project relates to a proposal to construct a basement in the rear garden of a large house which is in the middle of a row of similar terraced houses.

The existing house had a lower ground floor where the floor level was approximately 2m below garden level. The terrace is founded in London Clay at a reasonable depth below ground level.

The proposals included:

- Underpinning the rear wall of the house by 2m
- Forming a contiguous piled wall to one side and the end of the garden
- Forming a reinforced concrete wall very close to the boundary on the fourth side of the basement using “underpinning” techniques.

There was no ground water found during the site investigation.

Design

Structural engineering drawings, proposed sequence of construction and temporary works proposals were provided as part of the approval process. During the party wall negotiations, the adjoining owners advisors requested that the underpinning be stepped up along the party walls to mitigate the sudden change in founding level of the rear wall and party walls as a result of the proposed underpinning. They also queried the practicality of installing the reinforced wall using underpinning techniques. The engineers produced detailed sequences to show how this could be carried out and how the reinforced wall would be supported using temporary props to maintain lateral stability.

Although the entire terrace of houses was founded on London Clay, the foundation level was in the region of 2.5m below original ground level and so the foundations of the houses were not subject to seasonal variations in moisture content. As such, the London Clay provides a reasonably stable founding material for these buildings and forming a basement as proposed should have been a relatively straightforward undertaking.

Construction

The underpinning to the rear walls and stepped underpinning to the party walls was carried out successfully, as was the contiguous piled wall to one side and to the end of the garden. Problems arose with the construction of the reinforced wall to the fourth side due to a lack of adequate lateral support by the contractor when the basement was excavated. This was not picked up by the designers possibly because of a lack of involvement on site during the construction process. The effect of this was that the adjoining garden moved laterally by 40 to 50mm, requiring reconstruction of the hard landscaping and reconstruction of the garden fence.

Conclusions

The construction of a reinforced concrete wall in this manner and excavation for a basement on one side of it may be feasible but it requires carefully considered sequences of construction and the installation of properly conceived temporary works by the contractors. While this form of construction could possibly be adopted adjacent to gardens, it is too risky in areas where it could impact on an adjoining building. The use of a contiguous piled wall solution reduces the potential risks involved with basement construction. The lack of adequate temporary lateral support might have been picked up if the appropriate designers had an ongoing role during the construction process.

Case Study No. 1

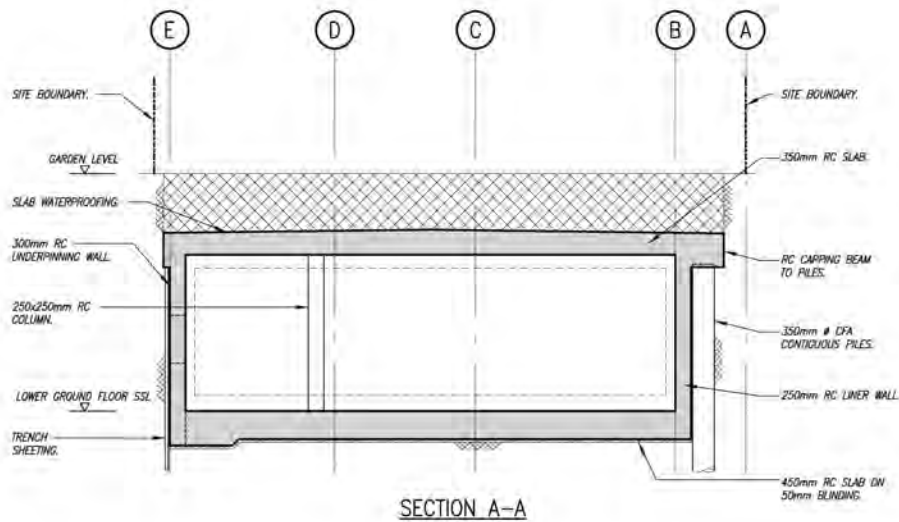
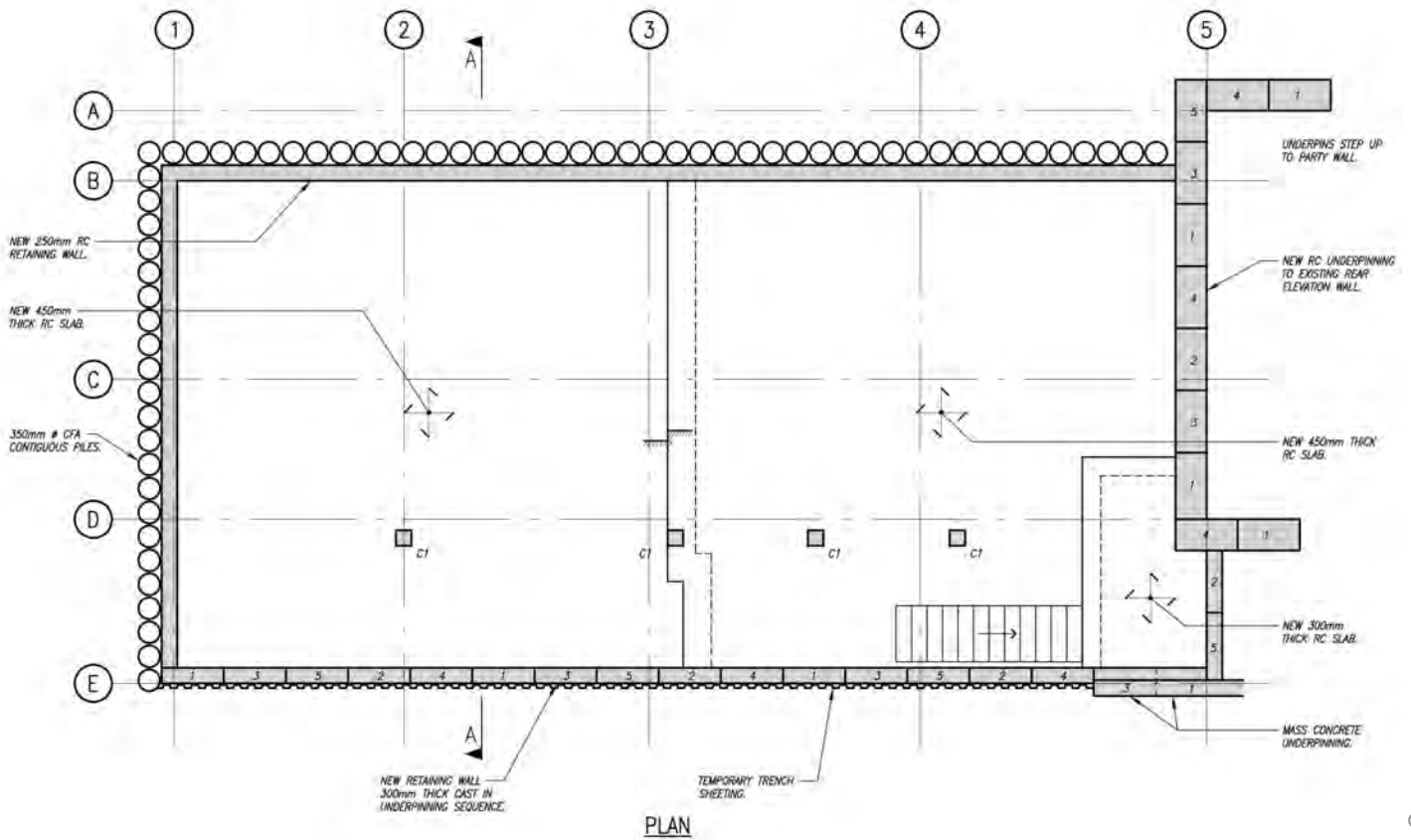

Case Study 2

New basement under Mews House

Project Description

This relates to a mews house which was in the same ownership as the main house. The whole property was being refurbished to a very high standard. There was a requirement to construct a substantial plantroom. This was to be located under the mews house. The mews house was much altered and the general condition was very poor so it was decided to only retain the party walls.

The mews was founded on a thin layer of Langley Silt over approximately 10m of gravel. The perched water level was 7m below ground level.

The proposals included:

- Underpinning the retained walls in two lifts to a total depth of 4.5m below the existing foundations. The underpins to the party walls were stepped up gradually towards the main house but this was not feasible with the adjoining properties.
- Construct a contiguous piled wall to form the rear basement wall
- Construction a reinforced concrete box within the underpinning and piled wall.

Design

Structural engineering drawings were provided as part of the approval process. These showed an indicative sequence of construction including the requirement to provide lateral restraint to the underpins at all times until the permanent works were complete.

The mews houses were all founded on, or very close to gravel and so were not subject to any seasonal movements, as the gravel forms a very stable founding material. The perched water table was more than 2.5m below the proposed underpinning depth, therefore the basement should have no impact on the ground water regime.

Construction

During construction detailed method statements, sequence of construction and temporary works were provided by the contractor and reviewed by the designers. The designers had an ongoing site visiting role. The underpinning and construction was carried out successfully with minimal reported damage occurring to adjacent properties.

Conclusion

Underpinning properties founded in gravel where the work is above the level of the perched water level can be successfully carried out provided the team fully consider and implement the sequence of construction and temporary works proposals. Using a contiguous piled wall is a better approach than reinforced concrete wall formed with underpinning techniques (see Case Study 1).

Case Study No. 2

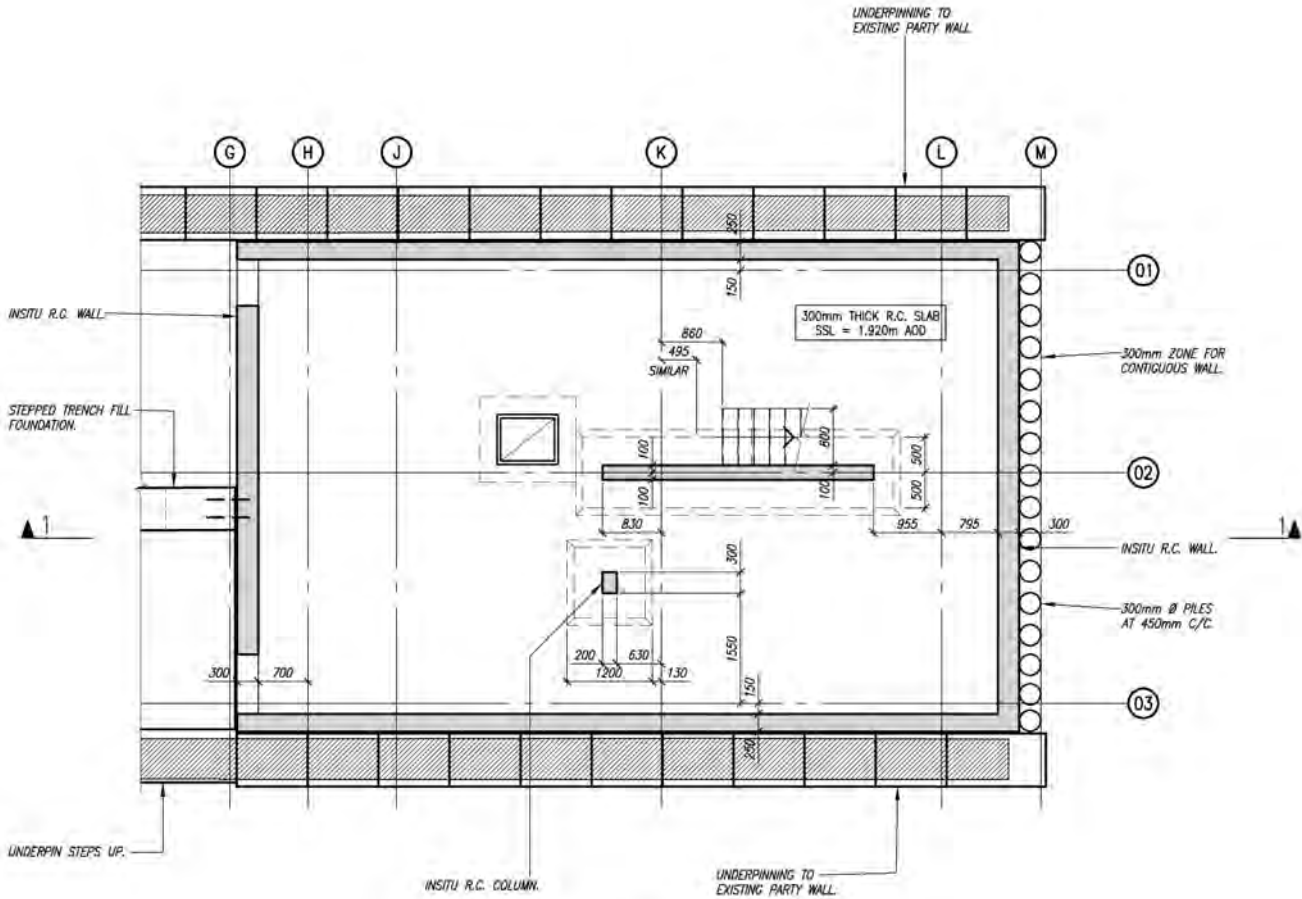

Basement Plan

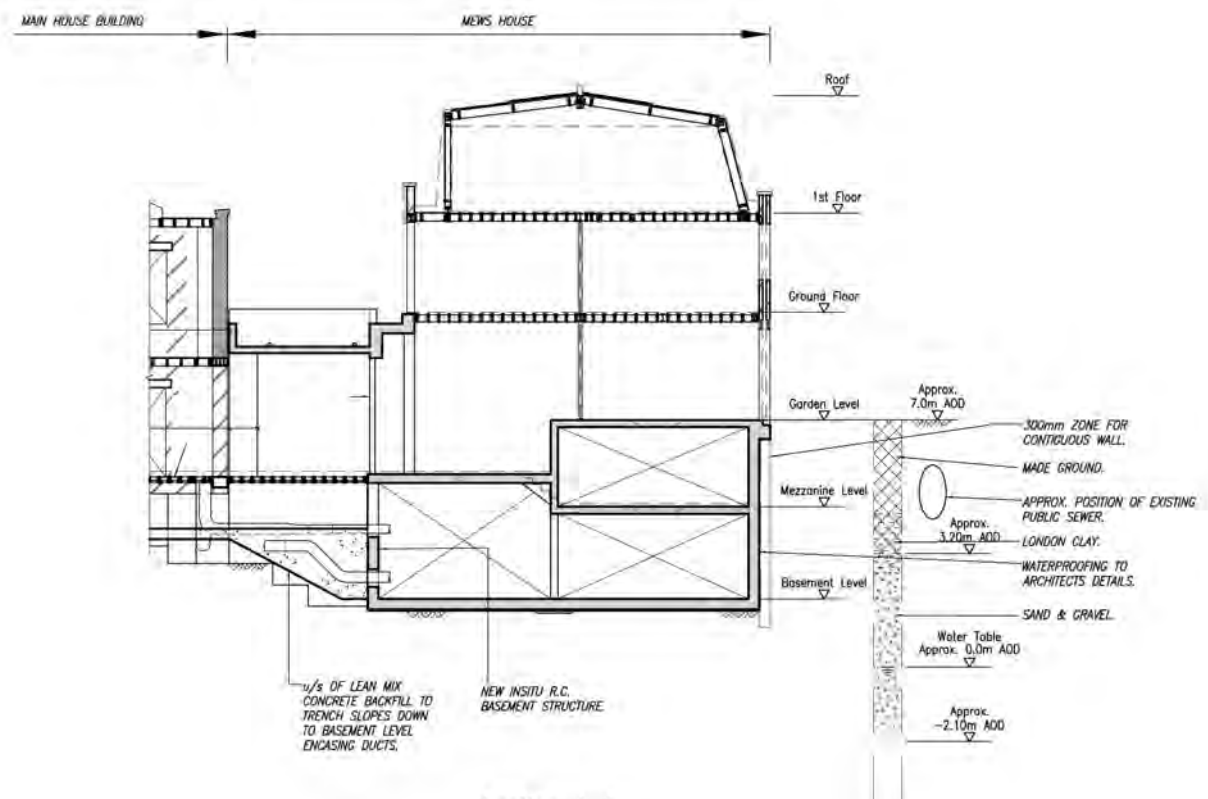

Section 1-1

Case Study 3

New Basement under Rear Garden of a Detached Listed House which Extends below the Water Table and into London Clay

Project Description

The project relates to the construction of a new two level basement in the garden of a large listed detached house. An underground link connection to the house was required.

The existing house has a lower ground floor level and was founded on gravel over London Clay. The gravel layer was approximately 3m thick, and there was 1.5m of perched water within the gravel.

The proposals included:

- Locally underpinning of the rear wall to form a below ground connection from the house to the basement. The underpinning extended below the water table.
- Form a piled wall to all sides of the basement box.
- Construct a reinforced concrete box within the piled wall using a bottom up technique.

Design

Structural engineering drawings, proposed sequence of construction and temporary works proposals were provided as part of the approval process. A 450mm diameter secant pile wall was proposed to minimise water ingress to the basement box. As the walls to the house were to be locally underpinned below the perched water level, chemical permeation grouting of the gravels was proposed. The house was founded well below ground level on gravel, but stepped underpins were provided to mitigate the change in founding level. A general assessment of the potential cumulative effects of basement construction on any groundwater flow was carried out and it was concluded that in this instance this was not a concern.

Construction

During the underpinning operations, even following repeated permeation grouting, there was an inflow of groundwater to the excavation which was difficult to control. There were significant problems with forming the secant piled wall with piles being out of tolerance so that they did not interlock. This can be a problem for small diameter secant pile walls particularly where a mini piling rig is used – 600mm diameter is usually the minimum size recommended to reduce the risk of this occurring.

The lack of fit of the piles required extensive measures to control groundwater inflow and to remove and rebuild some of the piles where they protruded too far into the basement.

The contractor proposed a different sequence and method of propping but following reviews, this was considered acceptable.

No significant settlements or ground movements were noted.

Conclusion

Construction below the water table adds significantly to the complexity of the scheme, particularly where the gravels are very permeable. Small diameter secant piled walls i.e. less than 600mm diameter, can be difficult to construct so that they fully interlock.

Case Study No. 3

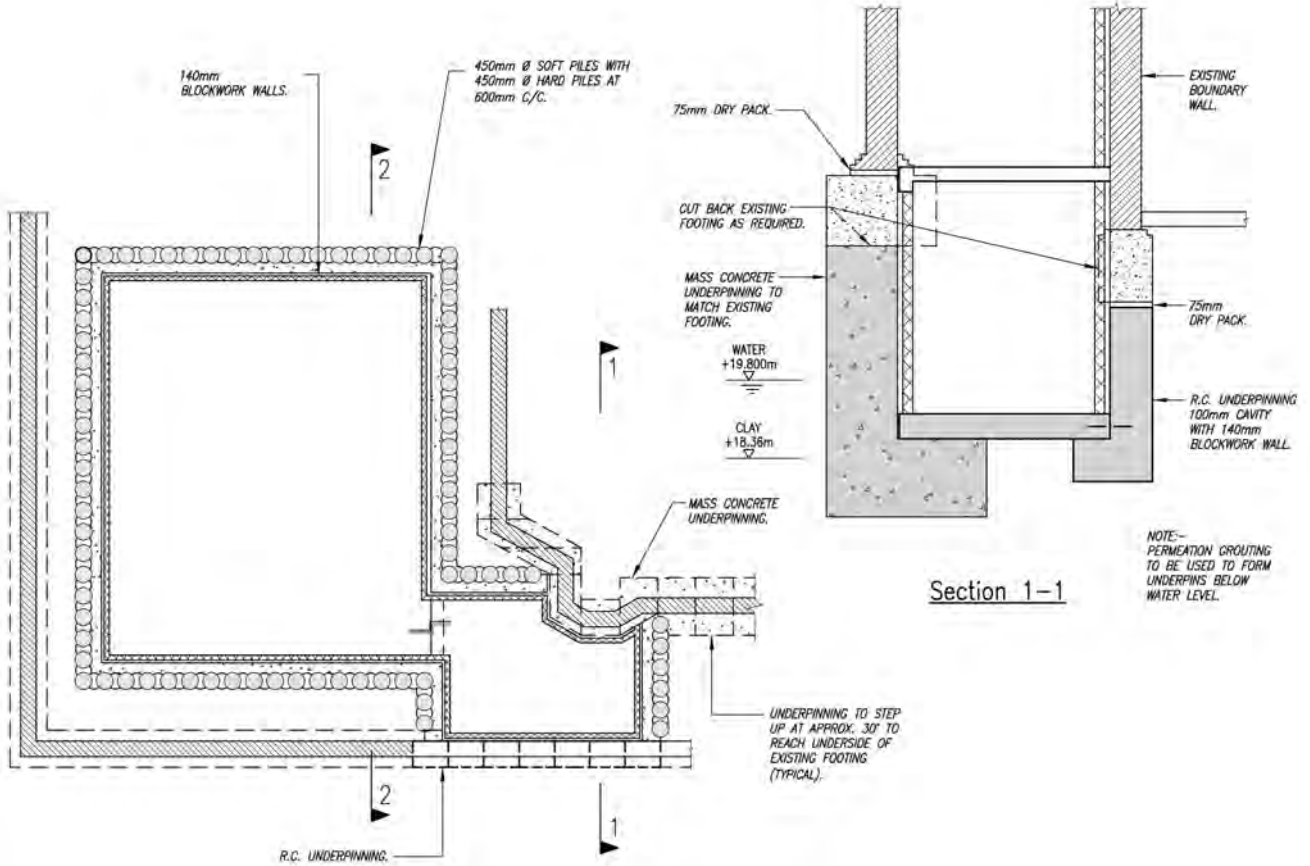

Plan

Section 1-1

NOTE: PERMEATION GROUTING TO BE USED TO FORM UNDERPINS BELOW WATER LEVEL.

Appendix C

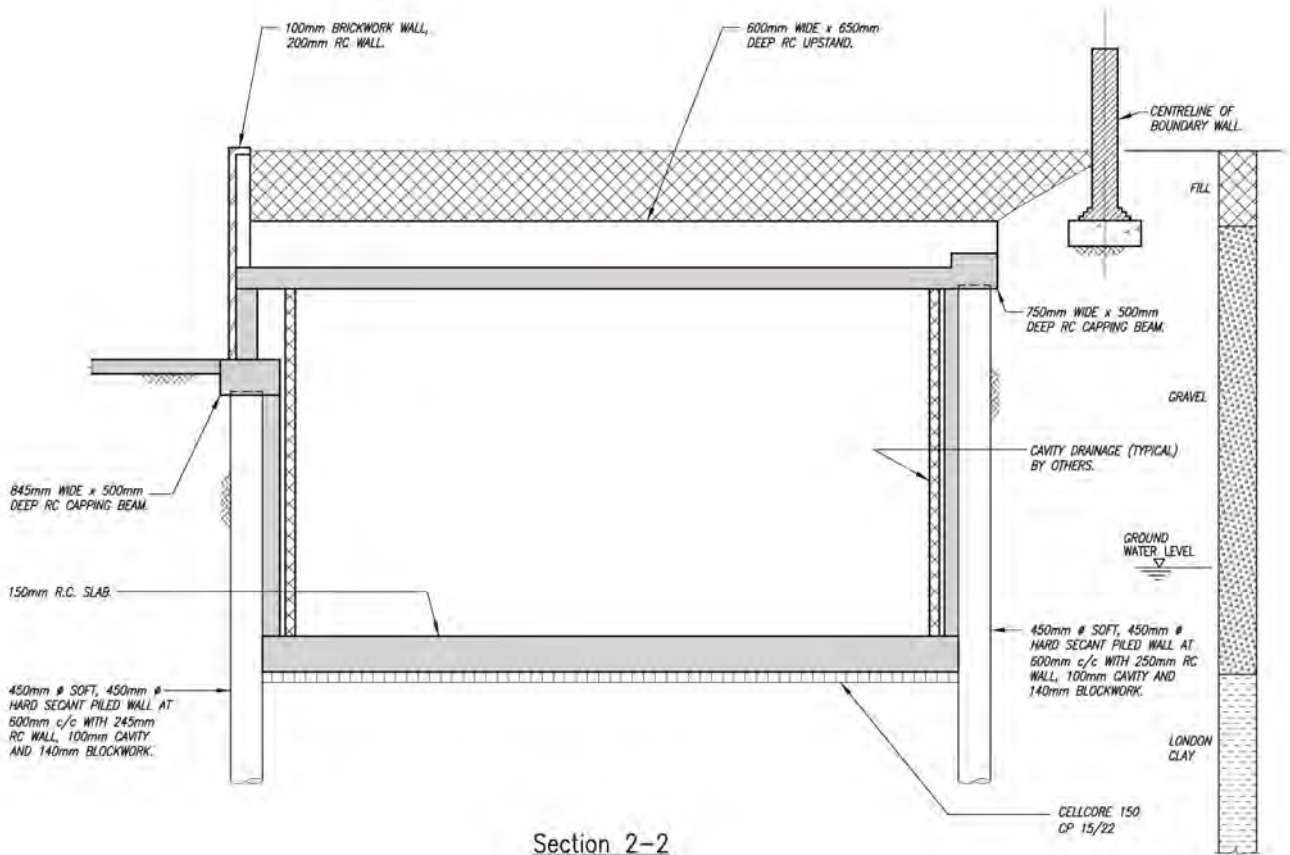

Section 2-2

Appendix D

The Historical Development of Kensington and Chelsea

- D.1 The Anglo-Saxon settlements of Kensington and Chelsea (with Kensal to the north) existed separately over many centuries before they were gradually absorbed by London from the late 17th century. By 1086, however, the Manor of Chelsea was owned by the Earl of Salisbury, and Kensington by Aubrey de Vere.
- D.2 After 1520, Sir Thomas More, Lord Chancellor to Henry VIII, built Beaufort House near the river and other nobles followed including the Duke of Norfolk, the Earl of Shrewsbury and Henry VIII. All built large show houses and Chelsea became known as the 'Village of Palaces'. Further north, in the 1590s Sir Walter Cope began to purchase land in Kensington, and in 1604 he built Cope's Castle in what is now Holland Park. James Hamilton's 1664 map of Kensington and Chelsea shows Chelsea and Kensington as villages focused on their parish churches, with grander houses stretching along the riverfront at Chelsea and on the higher land between Kensington High Street and Notting Hill Gate.
- D.3 Nottingham House, purchased in 1689 by William III as a country house, was enlarged by Christopher Wren to become Kensington Palace. Nearby Kensington Square (begun 1685), until then a failing venture, became a popular residential quarter. The square introduced the red brick terrace to the area. The arrival of the Court also created a boom in trade and by 1705 John Bowack would describe Kensington as having an 'abundance of shopkeepers and ...artificers...which makes it appear rather like part of London, than a country village.'
- D.4 Otherwise the area remained largely rural in character, with the southern part towards Chelsea known for its market gardens and nurseries from the late 16th century until the mid-19th century when the land was required for housing. The King's Road became a centre for horticulture.
- D.5 Many Georgian houses from the early 18th century remain in the Chelsea area but most of the larger houses built by Elizabethan or Jacobean courtiers and merchants have been redeveloped. In 1705 Chelsea had about 300 houses but by the end of that century the village had spread north to house a population of some 12,000.
- D.6 The late 18th century was another period of expansion for Chelsea, which had remained a riverside village with variegated domestic building types. Hans Town (Hans Place and Sloane Street, built from 1777 and redeveloped as tall brick terraces by the 1870s-80s) and Knightsbridge were among the neighbourhoods to be developed at this time. Chelsea began to join up with London proper.

- D.7 In Kensington development was patchier but, from 1811, Lord Kensington was granting leases west and south of Kensington High Street. The pace of change accelerated with the end of the Napoleonic War until the financial crash of the late 1830s. Edwardes Square (1811 – 1819) was a forerunner of the garden squares that later characterised the area. Brompton and Hereford Squares were being developed in the 1830s and 40s. Modest streets of smaller houses extended towards Campden Hill.
- D.8 Still, as Pevsner notes, even by 1837 much of the area outside the original villages. remained rural with sporadic development along lanes that were developing into the three main highways to Fulham, Hammersmith and Uxbridge. The population of Kensington (excluding Chelsea) rose from 8,556 in 1801 to nearly 27,000 by 1841. A decade later it had exploded to 44,000.
- D.9 The 100-acre Brompton Park nursery was given over to building in the mid 19th century and formed an extension of Knightsbridge. The Italianate stucco influences that were to dominate much subsequent development first became notable here (and also found their way into northern Chelsea). Villas were as less common domestic type and those that were built have often been redeveloped in order to make more economical use of land available for building plots. Some Villa's remain, scattered around Holland Park and towards Kensington Gardens.
- D.10 Northern Kensington remained in agricultural use well into the Victorian era, with two farms, Notting Barns and Portobello occupying some 400 acres of land – most of the area. Both were given over to building by the mid 19th century. Development began on the Norland Estate; this was followed by the Ladbrooke Estate, where large terraces and (with land somewhat cheaper) some villas were built, especially in Notting Hill with its crescents of stucco and brick around communal gardens. This was the continuation westward of the development of Bayswater in the City of Westminster that had first begun in the early 19th century.
- D.11 Two events were especially important to the thorough-going urbanisation of Kensington & Chelsea during the 19th century. Firstly, the Great Exhibition of 1851: With the profits from the exhibition, the 1851 Commissioners purchased 87 acres, creating Albertopolis in South Kensington and giving the area the cachet of Mayfair. The hugely tall stucco terraces of the streets around Queen's Gate swiftly followed – speculatively built and ponderously Italianate until visual Dutch Renaissance red brick began to break the monotony from the 1870s, when the latter style was especially popular around Holland Park and was followed in the 1880s by the fashion for red-brick houses with 'Queen Anne' details.

- D.12 The second important event was the extension of the District and Metropolitan railway. By 1871 the whole area from Sloane Square to West Brompton and from Kensington High Street to Notting Hill was served by rail. The lines in the east served already built-up areas, while those in the west acted as an impetus for more, increasingly dense development.
- D.13 That more profits were to be had from speculative building than from agriculture was by this time well-established and London expanded rapidly from east to west across the area. Between 1850 and 1880 heavy urbanisation continued, with the development of great estates often ensuring a consistency of architectural approach.

South Kensington remained a high-class residential area composed mainly of large terraced houses of the 'premier type'. Smaller speculative developments characterised Chelsea at this time, with thousands of houses built during the 1860s and 70s. Further west the buildings of Earl's Court Farm were demolished and its 190 acres sold for development between 1875 and 1878.

- D.14 The late 19th century also saw houses give way to flats. In the form of mansion blocks had arrived with all mod cons. Norman Shaw's Albert Hall Mansions of 1879 led the way. Another new building type, pioneered by Shaw in Melbury Road South of Holland Park, was the purpose-built artists' house incorporating studio and living space. Some areas around Kensington High Street and Earl's Court became solidly flatted but Chelsea, with notable exceptions such as Sloane Avenue, remained at a smaller scale and developed in a mix of architectural styles: the influence of the Arts & Crafts remains visible in areas such as Tite Street which was developed in the 1870s.
- D.15 While the 20th century has seen further blocks of flats built in Kensington, much of the borough is still made up of the housing stock that was present when urbanisation reached its peak before the First World War.
- D.16 However the area from Notting Hill north to Kensal Green has experienced massive change since the Second World War, due to, slum clearances, the redevelopment of the industrial sites of the potteries and refuse collectors to the north of the Norland Estates and the creation of the Westway. New developments in the north of the borough varied from Goldfinger's Trellick Tower (completed 1972) to more contextual infill around St Mark's Road.
- D.17 Apart from further high-rise developments around World's End the scale of Chelsea remains, on the whole, much more modest. The housing stock remains less homogeneous than Kensington's and more artisanal. Despite the building of the Embankment (and Second World War bombing) the narrow streets of village Chelsea running back from the river remain insitu.
- D.18 The joint borough, created in 1965, remains one of the most densely populated in the capital.

References

- 1 Scoping Study
- 2 Pevsner: London 3: North West
- 3 Survey of London Volumes:
 - Chelsea, pt I - Walter H. Godfrey (1909)
 - Chelsea, pt II - Walter H. Godfrey (1913)
 - Chelsea, part III: The Old Church - Walter H. Godfrey (editor) (1921)
 - Northern Kensington - F. H. W. Sheppard (General Editor) (1973)
 - South Kensington Museums Area - F. H. W. Sheppard (General Editor) (1975)
 - Brompton - F. H. W. Sheppard (General Editor) (1983)
 - Kensington Square to Earl's Court - Hermione Hobhouse (General Editor) (1986)
 - Knightsbridge - John Greenacombe (General Editor) (2000)
- 4 The History of the Borough as told in the Virtual Museum: <http://www.rbkc.gov.uk/virtualmuseum/> Accessed, 2nd August, 2012.

