

Arup**Geotechnics**

Royal Borough of
Kensington & Chelsea

**RBKC Town Planning
Policy on Subterranean
Development**

Phase 1 - Scoping Study
DRAFT

Document ref
REP/123002/001/DRAFT

REV B

ARUP

ArupGeotechnics

Royal Borough of
Kensington & Chelsea

**RBKC Town Planning
Policy on Subterranean
Development**

Phase 1 - Scoping Study
DRAFT

June 2008

Ove Arup & Partners Ltd
13 Fitzroy Street,
London W1T 4BQ
Tel +44 (0)20 7636 1531 7755 2121
www.arup.com

This report takes into account the particular instructions and requirements of our client.

It is not intended for and should not be relied upon by any third party and no responsibility is undertaken to any third party

Job number 123002

Job title	RBKC Town Planning Policy on Subterranean Development	Job number	123002
Document title	Phase 1 - Scoping Study DRAFT	File reference	67
Document ref	REP/123002/001/DRAFT		

Revision	Date	Filename	RBKC-Sub-Dev-ARUP-Phase1-ScopingStudyReport-Nov07-ISSUE.doc		
Issue	13/11/07	Description	Draft issue for review and comment by RBKC		
			Prepared by	Checked by	Approved by
		Name	Vicki Hope / Pietro Bologna	Vicki Hope	Tim Chapman
		Signature			
Rev A	29/01/08	Filename	RBKC-Sub-Dev-ARUP-Phase1-ScopingStudyReport-Jan08-ISSUE.doc		
		Description	Draft issue for public dissemination		
			Prepared by	Checked by	Approved by
		Name	Vicki Hope / Pietro Bologna	Vicki Hope	Tim Chapman
		Signature			
Rev B	30/06/08	Filename	RBKC-Sub-Dev-ARUP-Phase1-ScopingStudyReport-30Jun08.doc		
		Description	Draft FINAL (following public consultation)		
			Prepared by	Checked by	Approved by
		Name	Vicki Hope / Pietro Bologna	Vicki Hope	Tim Chapman
		Signature			
		Filename			
		Description			
			Prepared by	Checked by	Approved by
		Name			
		Signature			

Issue Document Verification with Document

Contents

	Page	
1	Introduction	1
	1.1 Scope	1
	1.2 Community involvement and consultation	1
2	Subterranean development	3
	2.1 Types of subterranean development	3
	2.2 Typical construction methodology for basements	4
	2.3 Summary of principal issues for consideration	7
3	Royal Borough of Kensington and Chelsea	11
	3.1 General context of the Borough	11
	3.2 Geology of the Borough	11
	3.3 Hydrogeology of the Borough	13
4	Planning applications for residential basements in the Borough	16
	4.1 Introduction	16
	4.2 Overview of data	16
	4.3 Observations on the incidence of basement applications	16
5	Discussion of the main effects of basements	19
	5.1 Underground water	19
	5.2 Surrounding buildings	20
	5.3 Sustainability and legacy	22
	5.4 Nuisance caused during works	23
	5.5 Safety during the works	23
	5.6 Hazards to passers-by	24
6	The planning context for basements	25
	6.1 UDP	25
	6.2 LDF: public consultation	25
	6.3 LDF: mechanisms under the new framework	26
	6.4 Other consent processes and constraints	26
7	Conclusions of Phase 1 scoping study	30

Appendices

Appendix A

Effects of excavation on foundation strengths

1 Introduction

1.1 Scope

The Royal Borough of Kensington and Chelsea (RBKC) has set up a study of Town Planning Policy on Subterranean Development in response to a rise in the number of planning applications involving subterranean development in the Borough, and an increase in the public's perception of the potential adverse impacts of such developments. The Council's existing development plan (the Unitary Development Plan, UDP) includes several policies relating to subterranean development and, at present, these policies guide the assessment of planning applications in the Borough. The new Local Development Plan (LDF) is currently being drafted and this will eventually supersede the UDP. The Council seeks to ensure that the new LDF shall include appropriate content relating to subterranean development, and that this content shall be configured to be defensible at the Examination in Public of the LDF Core Strategy and also at any future appeal against a refusal of planning permission under the LDF.

In devising the project, RBKC has recognised that it is a relatively novel form of multidisciplinary study, as it combines both geotechnical, structural, hydrogeological and town planning elements. The Council has therefore designed the project to be in two phases:

- **Phase 1 – Scoping Study:** the initial scoping study aims to identify and assess the likely importance of factors and issues considered as being potentially relevant to policies on subterranean development in the Borough.
- **Phase 2 – Implementation Stage:** the scope of Phase 2 is dependent on the outcome of the Phase 1 work, and therefore has not yet been defined in detail. Broadly, it is anticipated that Phase 2 would include the preparation of draft policies for possible inclusion in the LDF, and a report justifying these recommendations.

Ove Arup & Partners Ltd (Arup) has been commissioned by RBKC to undertake Phase 1 of the two-phased Subterranean Development study. The main deliverable of the Phase 1 work is the Scoping Study Report, presented here.

By its nature, this report mainly focuses on the potential dis-benefits and hazards of subterranean development in urban areas. However, it is also important to highlight the potential benefits of subterranean development within the Royal Borough of Kensington and Chelsea. Amongst the principal advantages of below-ground development in the Borough is the increased space available to householders and to businesses. Any subterranean development policy must reasonably balance the aspirations of property owners with the wider effects of these aspirations on current and future neighbours, as well as the environment.

This report has been produced for the use of RBKC in connection with the Council's policy study relating to subterranean development in the Borough. It is not intended for and should not be used by any third party.

1.2 Community involvement and consultation

As part of its community involvement and consultation processes during the development of the Local Development Framework, a draft of this Scoping Study report was published on the Council's website in January 2008 and made available to Councillors, resident groups, amenity groups, utility groups, professional organisations and government organisations. The draft Scoping Study was accompanied by an invitation for questions on the draft report to be sent to the Council by email and telephone. In addition, a public meeting was held on

11th March 2008 at which Arup presented a summary of the report, and attendees had an opportunity to submit questions. The questions received were grouped by the issues they raised and Arup and RBKC responded to the questions, amending the report where appropriate. The updated version of the Scoping Study (this document) shall be presented to Council Members and used to inform the Council's planning policy approach to Subterranean Development.

2 Subterranean development

2.1 Types of subterranean development

Within the Royal Borough of Kensington and Chelsea, the most common types of below-ground development typically include:

- Tunnels for transport and utilities
- Commercial developments: offices, retail, underground car parking, plant rooms
- Cultural buildings: museums, concert halls, theatres, lecture halls, churches
- Basements under residential properties and their gardens
- Basements under existing open spaces.

Each of these is considered in turn below:

- **Transport tunnels** in London tend, nowadays, to be built deep below ground because they must pass under existing tunnel infrastructure and deep foundations along the tunnel route. Major projects of this type (for example Crossrail) are generally the subject of a Parliamentary Bill, and do not fall within the remit of local authority planning offices.
- Basements in **commercial developments** such as purpose-built office blocks are usually constructed at the same time as, and integral with, the above-ground structure with which they are associated. It is unusual for basements in commercial properties to be extended or deepened whilst the existing above-ground structure is left in place. Commercial developments are usually of a size and cost that attracts the participation of design engineers and major contractors who have experience of large-scale construction work.
- Basement developments in **cultural buildings** such as museums, schools and churches tend to be extensions, by widening and/or deepening, of existing basements. (For wholly new developments, the comments about commercial developments, given above, would be applicable.) In the case of churches, the deepening of undercrofts and crypts has become a more frequent method of increasing available space for meeting rooms *etc.*
- Subterranean developments below **residential properties**, including new basements and extensions to existing cellars, are increasingly prevalent within the Borough. In general, household basement projects are not of a size or cost to attract major engineering design or construction firms, and there have arisen numerous smaller companies who have specialised in this type of work. Where a new residential basement is close to other houses, especially in terraces, the potential risk of damage to adjacent properties is often of greater concern to neighbouring owner-occupiers than would be the case for a subterranean development in a non-residential, business district.
- For subterranean development below **open spaces**, the most common type has been underground car parks. Such developments are governed by the current planning guidance and policies that now strongly aim to discourage car use in London, as well as local planning policies to protect trees and green areas, particularly the current RBKC policy to resist development beneath historic garden squares in the Borough.

From this brief review, it is evident that there has been a wide variety of subterranean development activity within the Borough, and that the development of basements under residential properties is a special case of interest for residents of the Borough. This scoping study therefore considers:

- (i) the overall effects of any type of subterranean development in the Borough;
- (ii) the specific local effects of residential subterranean development.

2.2 Typical construction methodology for basements

As background to understanding the context of basement developments in the Borough, this section summarises the construction techniques that are typically used to form:-

- “Small” basements: including new basements and basement extensions of the type most typically encountered in residential properties.
- “Large” basements: including commercial and deep basement developments.

This section is intended as descriptive only, and it should not be considered as presenting technical guidance.

2.2.1 Small basements

2.2.1.1 Introduction

This section summarises the construction methods that are typically adopted for small basements typical of subterranean developments in residences. This includes new basements and basement enlargements, both beneath house footprints and under gardens. The wide variety in the existing building stock of residential structures within the Borough in terms of age, method of construction, and quality of construction means that a site-specific approach to any major structural intervention, including basement works, is an essential element of any individual project. The discussion here is general.

A generic C19th or early C20th house can be considered. In London, the foundations of traditionally-built, two-storey residential buildings typically comprise “strip” footings made of bricks that support the external and internal main walls. Such foundations usually extend at most about 1.5m below street level. Since the minimum headroom required for a habitable space is 2.4 m, the creation of a single-level basement would require a deepening of at least 2m below the underside of the existing footings in order to reach the new basement’s floor level. Moreover, in order to maintain overall stability, it will usually be necessary to undertake further deepening beneath the basement floor level in order to form new foundations. The subject of foundation stability, and its potential variation with soil type, is discussed in Section 5.2 and Appendix A.

The most usual construction methodology adopted for basement construction and enlargement under existing buildings is **underpinning**. An alternative technique that is sometimes used to strengthen existing foundations is **mini-piling**: this uses small-diameter piles, which are threaded through the existing foundations. If the area above a proposed basement is fully accessible to construction plant and equipment, as is often the case for a basement being built in a garden, then the **cut-and-cover** technique can be used.

As well as the structural engineering aspects of the basement works, other relevant issues include waterproofing, drainage, flooding, ventilation and lighting. For the latter two, there is a broad range of options and these are not considered in detail in this report. Waterproofing is a key element in the successful design of a basement: most insurance claims about basements are for water leaks. Even well-built concrete basement walls will not reliably keep out dampness in the long term. Membranes can be applied either externally (in contact with the soil) or on the interior faces of the basement sidewalls and base slab. The membranes can either be designed to constitute a physical barrier to the water, or they can be designed to convey any incoming water into a drainage system, where it can flow to a collector equipped with pumps.

It is appropriate to consider some practical issues that relate to the construction process for new basements beneath existing buildings, including the need for site facilities such as washrooms, plant and machinery, site deliveries, access down into the subterranean work area, space for stockpiling excavated soil, storage of construction materials, protective hoardings etc. The availability of space for construction works in a residential area is usually relatively limited, and therefore optimisation of the site layout is an important issue in practice. Construction facilities can occupy gardens or backyards where available, otherwise some overspill onto public space, such as footways and roadsides, may be needed, where permitted.

Time and costs for residential basement projects vary considerably. Currently (Autumn 2007), commercial firms typically estimate the average cost for a new basement built under an existing house to be approximately £2,000 per square metre. Works durations typically vary between 3 to 6 months of continuous construction.

2.2.1.2 Underpinning

Underpinning is executed in a series of gradual steps. It relies on the integrity of the surface wall to share load whilst small sections are progressively undermined. A typical process is illustrated in Figure 2.1.

- The first step is the exposure of the top of the existing foundation, by breaking out the existing ground floor slab along the edge of the foundation that is to be underpinned (Figure 2.1a).
- The next step is to excavate along the existing foundation in a series of small sections (each typically of length 1m to 1.5m), in a “hit and miss” pattern that alternates an excavated section with one where the soil under the foundation is left in place (Figure 2.1b). In the case being considered, each pit would be approximately 2m deep. The excavation is often done by hand. If there is groundwater present, this must be locally pumped to enable the works to progress.
- When a series of spaced gaps under a particular run of wall has been excavated, concrete is cast under the existing foundation, thus filling the excavated holes to form underpins.
- After the concrete in the first set of underpins has cured, the remaining intermediate sections of soil (which have been left in place between the first underpins) can be gradually excavated piecemeal. Concrete underpins can then be cast into these holes. Together, the series of underpins form a continuous, unreinforced, concrete strip footing.
- If the depth of the row of underpins formed is not sufficient, the same process can be repeated, but this time digging and underpinning below the new concrete foundations.
- When the full perimeter of the basement area has been underpinned in this manner, extending down to the necessary depth, the full excavation of the basement space can proceed, followed by casting the basement floor slab of the basement and fitting out the basement interior.

2.2.1.3 Underpinning using piling

Piles of small diameter, usually called mini-piles or *pali radice* (= “ground roots”) can be used as an alternative to concrete underpinnings (see Figure 2.2). This technique requires specialist machines (piling rigs), which must be able to access the full perimeter of the basement construction area. The piling rigs are used to drill holes (inclined or, more rarely, vertical) into the ground via the existing foundations, and then reinforced concrete is cast in the boreholes. The piles enhance the strength of the original foundation, and thereby contribute to the stability of the building and help minimize settlements. This piling

technique can be an effective way to reinforce and strengthen existing foundations, but it is usually more invasive in terms of noise and vibration, caused by the operation of the piling rigs, than traditional underpinning.

2.2.1.4 Cut-and-cover

The cut-and-cover technique can be adopted wherever the ground above the proposed basement is freely accessible, such as basements under gardens or backyards (Figure 2.3). First, a series of vertical piles is installed close to each other, in a row along the perimeter line of the proposed basement. The piled wall that is formed in this way should be designed to be strong and rigid enough to be able to support the soil around the basement without excessive ground movement when the basement is dug. When the soil has been excavated from the basement space down to the floor level of the basement, the basement base slab is cast. Within the basement, a secondary internal wall is often installed, leaving a drainage gap between the inner wall and the outer piled wall: any incoming groundwater seepage entering this space can be collected in a sump, and pumped away. Finally, the "lid" or "cover" (that is, the ground floor slab) is installed and the garden can be reinstated. When a single-storey basement is structurally complete, both the ground floor slab and the basement slab act to provide structural support to the piled wall. For a multi-level basement, the intermediate floors also help provide this lateral support. However, before the slabs can be installed, it is often necessary to use temporary props to help support the piled wall during the excavation stage of the works. In general, the excavation works are at their most vulnerable to ground movements, or even to collapse, during this intermediate stage before the permanent floors and slabs can be installed.

2.2.2 Large basements

For commercial basement developments, such as those beneath office blocks, it is usual for the basement to be constructed on a cleared site, rather than to be added beneath an existing building. The basic engineering techniques needed are essentially similar to those described above for residential developments, but are typically on a larger scale. Multiple levels of basement are relatively common in commercial developments, as the marginal cost of adding more floors is often attractive to developers.

For a basement that is being built on a cleared site (*i.e.* where the previous building, if any, has already been demolished and razed), the most usual construction technique is, in essence, the **cut-and-cover** method described above (Section 2.2.1.4), albeit on a larger scale. Reinforced concrete piles, or similar, are installed around the perimeter of the proposed basement, and then the soil from within the footprint of the basement is excavated. During this digging phase, the piled sidewalls will, unless suitably supported, tend to bend inwards towards the excavation, pushed by the weight of soil retained behind the walls. Indeed, for a multi-level deep basement with several floors, the ground movements associated with this are likely to be unacceptably high, unless mitigated. In practice, these ground movements cannot realistically be reduced to zero, but several techniques have been developed to minimise and control the movements to acceptable levels:

- **Bottom-up construction:** in this approach, the soil within the area enclosed by the piled sidewall is gradually excavated, but, as the excavation deepens, it is usually necessary to temporarily support the sidewall using props or struts. When the excavation reaches the depth of the basement base floor slab, this is cast in place. When the concrete cures, the presence of this deepest slab immediately starts to help to support the sidewalls, and the slab augments the props. Next, any intermediate basement floor levels (if it is a multi-level basement) are cast and finally the ground floor slab is cast. As each of these floors is cast, fewer and fewer temporary props are needed, and gradually these are all removed.

- **Top-down construction:** in this scheme, the basement floor slabs are cast whilst the excavation proceeds, and no temporary propping is needed. First, before any digging starts, the slab for the new ground-floor level is cast. A hole is left within this slab to allow access for workers, excavation machinery and the dug soil. Digging then proceeds under the slab: this work is descriptively named “moling”. When the excavation reaches the level of the next basement floor, that slab is cast (again with an access hole), and moling continues below the second slab. A key structural advantage of the “top down” approach is that the floor slabs offer a very rigid, box-like support to the basement sidewalls from the outset. When done properly, the ground movements arising from the top-down basement construction process are relatively small. For commercial developers, another advantage is that work on the new building above (the superstructure) can progress at the same time as the basement works, which can significantly reduce the overall construction period.

Where there is a party wall (a shared wall between neighbouring properties), underpinning techniques, using the step-wise construction technique described in Section 2.2.1.2, are usually adopted. Similarly, for shallow basement extensions under existing commercial buildings, underpinning is also often used. The construction of deep, multi-level basement extensions beneath an existing commercial structure is unusual, and is not considered in detail here.

Proposed deep basements located over existing tunnels present specific design challenges. Figure 2.4 outlines the principal existing and proposed transport tunnels in the Borough. The excavation of soil from within the proposed basement space would cause a reduction in the stresses and loads experienced by the tunnels. In addition, the ground would move up slightly (heave) when the weight of soil is removed from the basement space. London Underground Ltd and other tunnel operators (such as telecommunications companies) require that subterranean developers provide detailed engineering calculations to show that a proposed basement will not adversely affect their tunnels by causing ground movements or stress changes.

2.3 Summary of principal issues for consideration

The tender documentation produced by RBKC for the Local Development Framework (LDF) Subterranean Development Policy project included a Consultants’ Briefing document (dated February 2007; entitled “*Appendix A: Considerations; Section 3: Types of Problem*”). The Briefing document outlined the principal concerns relating to the insertion of new basements. A summary of the main topics highlighted in the Briefing document is presented below, along with other issues identified by Arup. The range and variety of the listed items illustrate the diverse but interconnected nature of the factors associated with assessing proposals for subterranean development within the Borough. Not all the topics come within the remit of the Planning Office, but it is appropriate to discuss all the issues as they inform the wider context of subterranean development.

- **Movements in the ground:** Underground construction will always – inherently and unavoidably – cause some movement in the surrounding ground. A basement scheme that is poorly designed and/or constructed would tend to cause greater ground movement and, hence, have greater potential for perhaps damaging adjacent structures and facilities than would a well-designed and well-executed scheme for which ground movements have been minimised and controlled. For basements close to the public highway, the halo of potential damage could extend through the footway into the road, affecting both buried services and traffic. The implications of damage induced by ground movements, including the potential for legal proceedings arising from damage to third-party property and structures, are significant. In practice, any responsible person undertaking a basement project would aim to avoid damaging their own property or neighbouring properties, not least because of the expense of putting it

right and of paying compensation for any attributable third-party damage. In practice, this issue is a fundamental and important driver.

- **Engineering design rigour:** For the development of commercial basement schemes in London, there are well-established and robust engineering processes available, including, for example: the quantitative prediction of likely ground movements; assessing permissible movements (based on the vulnerability of nearby structures); designing the basement and selecting the construction method to limit the induced ground movements; pre-condition surveys of adjacent buildings; monitoring of movements and other effects during construction, including crack monitoring; establishing contingencies to deal with adverse performance. For commercial basement developments, the Construction (Design & Management) Regulations (2007) apply in full. Amongst other things, the CDM regulations impose a duty on commercial clients to ensure that everyone involved in a project is competent and experienced. Under the CDM regulations, “domestic” clients have no special duties of care over whom they appoint to undertake works, although some residential projects can be as large as commercial schemes. In practice, of course, householders naturally endeavour to seek reputable firms and, although an individual householder is likely only ever to buy one basement and so cannot be considered an experienced client, people often make good use of word-of-mouth recommendations when selecting companies. However, it can be argued that small basement schemes, particularly for residential properties, are sometimes not tackled with the in-depth engineering rigour seen in large commercial schemes, which, it is important to note, is not to say that small basement projects are undertaken improperly.
- **Quality of design and workmanship:** Extending downwards beneath an existing building, especially old, masonry-built properties that were not designed to contemporary engineering standards and modern Building Regulations, is a challenging and potentially hazardous undertaking. Although collapses are rare, they do sometimes occur. The work involved in forming a basement under an existing structure is not trivial and it merits input from experienced professional engineers and contractors, including underpinning specialists. Problems are more likely to arise from inexperienced firms who are unfamiliar with the relevant design principles and techniques.
- **Cumulative effects:** The granting of permission to one applicant for a basement within a particular street often triggers several similar applications from neighbours. The cumulative effect - if any - of several underground developments in a given street could potentially differ from the impact of the initial “pioneer” basement. It is therefore appropriate to consider whether, for example, the layout and proximity of multiple basement schemes, especially adjacency of neighbouring schemes, is significant. If this is determined to be an important factor in engineering terms, then, within the context of planning policy, there could perhaps be provisions to ensure that any pioneering basements minimise the legacy problems that their schemes will leave for subsequent schemes in the local neighbourhood.
- **Foundation depth (clay soils):** The foundations for a new basement or basement extension built under an existing structure will be deeper than that building’s original foundations. In clayey soil areas in London, the problem of seasonal ground settlement (in dry summers) and ground heave (in wet winters) is well known. The most commonly used solution to the problem of subsidence on clay soils is to underpin the affected structure: that is, to deepen its foundations so that the new founding level lies well below the shallow, near-surface clay that is most vulnerable to seasonal shrinking and swelling. A by-product of adding a basement to an existing structure in clay soils is to accomplish this beneficial deepening. However, in the case of a pair of

properties that share a party wall (such as terraced houses), it is appropriate to consider and discuss whether or not deepening the footings of the party wall could perhaps adversely affect the structure on the other side of the wall in a clay soil area. This issue is arguably relevant both to underpinning for subsidence remediation works as well as basement works: in both cases, it is a site-specific factor that should be considered when planning, designing and implementing such works. The comments above about engineering design rigour and design quality apply.

- **Foundation stiffness:** Foundation “stiffness” is the engineering term that, in this context, relates the amount of settlement of a building under the load from the building. A new basement or a basement extension built under an existing structure will have deeper and hence, usually, stiffer foundations than that building’s original shallow foundations. It is appropriate to consider whether or not stiffening the footings on one side of a party wall may adversely affect the structure that shares the party wall, as there could perhaps arise an increased potential for differential settlements across the wall if the loading on the foundations were to change significantly in future. This possibility should be considered when planning, designing and implementing basement works at a party wall. Once again, the previous comments about engineering design rigour and quality apply.
- **Ground water:** A solitary, isolated basement is unlikely to affect groundwater flows: the water will simply find a new route and will flow around the obstruction. It is appropriate to consider and discuss whether a large basement (or a series of adjacent, contiguous basements) would have an adverse effect on the groundwater flow regime, and what the nature of that effect may be. Fortunately, this need not be a hypothetical discussion. Elsewhere in London and – most importantly - in similar geology to that found in much of the Borough, there are already several large areas (notably in the City of London) where much of the ground is fully or almost fully occupied by basements. This is discussed in Section 5.1.
- **Archaeology:** Most basement schemes in the Royal Borough of Kensington and Chelsea would involve removal of the shallow strata that, in general, have the highest archaeological potential. Possible planning conditions associated with archaeology restraints are therefore a relevant factor. Figure 2.5 summarises safeguarded zones within the Borough that have been identified as having special archaeological value or potential.
- **Uses of created subterranean space:** The principal potential uses of new underground spaces beneath private residences typically include car parking, leisure (swimming pools and gyms) and increasing the habitable space of the house, although not usually through provision of bedrooms or garden flats. New underground spaces could therefore potentially increase parking facilities within the Borough, but may also increase car usage and water consumption, both of which would have adverse effects on sustainability and environmental footprint. In general, such developments tend not increase the density of population.
- **Gardens and trees:** Most basement extensions cover the footprint of the existing building, but some schemes encompass both the house and garden footprint. Where a new basement extends under a garden, trees are likely to be felled. When the garden is reinstated, the lost trees are unlikely to be replaced, or would typically be substituted with smaller species types.
- **Environment – waste to landfill and carbon emissions:** The process of extending a property by digging downwards to form a basement will produce a considerably greater volume of spoil and require a greater volume of construction materials (notably concrete, which has a relatively high carbon dioxide emission rating) than would be typical in an above-ground extension to a residential property, such as a loft conversion

or conservatory. The excavated material taken from the basement space is likely to be “made ground” rather than natural soil, and it would have to be removed from the site (by lorry) and disposed of at a suitable landfill site as, typically, non-inert waste. The environmental “footprint” of a basement project is therefore not trivial, and should be viewed in the light of the Borough’s Environment Strategy.

3 Royal Borough of Kensington and Chelsea

3.1 General context of the Borough

The Royal Borough of Kensington and Chelsea (RBKC) extends from the River Thames at Chelsea Embankment in the south, past Hyde Park which lies to the east, up to Kensal Green in the north. RBKC is busy and densely populated, and it is home to a wide spectrum of socio-economic groups. The following summarises some key facts and figures:

- Land area: 12.13 square kilometres
- Population: 196,000
- Population density: 16,175 per square kilometre (*this is the densest in the UK*)
- Average size of household: 2 per property
- Proportion of private households: 78%
- Proportion of social housing tenants on housing benefit: 66%
- Proportion of incomes above £60k: 16.6% (*this is the highest in the UK*)
- Proportion of school children eligible for free school meals: 40%
- Number of listed buildings: more than 4,000
- Proportion of land designated as Conservation Areas: 70%

The building stock within the Borough is as diverse as its population. Across the Borough are areas occupied by terraced properties, semi-detached properties, detached properties, garden squares, and blocks of flats. In some parts of the Borough, buildings are close to their neighbours, and in other areas individual properties are set within larger grounds. Some districts include a greater proportion of commercial buildings, including office blocks. Much of the older building stock in the Borough is of traditional masonry-type construction, although the newer, multi-storey structures and apartment blocks are typically built of reinforced concrete.

3.2 Geology of the Borough

The sequence of soil and rock layers that lie beneath the topsoil in the Borough are, shallowest first (Figures 3.2 and 3.3):

- Made Ground, including archaeological remnants in places
- River Terrace Deposits, Alluvium, Brickearth (*but these are absent in the north*)
- London Clay
- Lambeth Group (comprising mixed layers of clays and sands)
- Thanet Formation (a dense sand)
- Chalk rock.

Of most relevance to basement developments in the Borough are the soil layers that lie nearest to the ground surface. The near-surface geology across the Borough is, broadly, in two distinct zones:

- In the north, the near-surface soil layer is the **London Clay**;
- In the south, the near-surface soil layer is mainly the **River Terrace Deposits**. This gravelly soil is underlain by London Clay.

There is much local natural variation in the details of the geology across the Borough (this is illustrated in Figures 3.1 to 3.3 and discussed below), but the north/south divide between the

clay and gravel is the key geological feature most relevant to the discussion of subterranean development in the Borough.

The London Clay layer is approximately 50m to 70m thick. Below the London Clay, the deeper geological strata that lie beneath the Borough are essentially similar across the whole district, albeit with some local variations in level. These deeper strata are of little relevance to most subterranean developments in the Borough, except for major tunnelling projects, and so are not considered in more detail here.

3.2.1 Southern part of the Borough: River Terrace Deposits

The geology of the southern half of the Borough is dominated by the presence of the prehistoric flood plains of the “ancestral” River Thames. The southern district is blanketed by soils that are collectively called the River Terrace Deposits, which comprise a complex mixture of sands, silts, gravels and clayey soils. In the prehistoric flood plain of the Thames, these soils were deposited along the river bank during major prehistoric flood events. These flood deposits would then be partly eroded by the river, before being buried under new debris from the next major flood event. This repeated sequence of flooding and partial erosion left behind a complex series of overlapping “terraces” of flood plain debris called the River Terrace Deposits. (Note: there have been several changes in the names of the gravels over the decades, introduced as geologists have refined their understanding of the complex depositional history along the river bank: the Flood Plain Gravel, Higher Flood Plain Gravel, Kempton Park Gravel, Taplow Gravel, Hackney Gravel, Lynch Hill Gravel and Boyn Hill Gravel are different names for parts of the “River Terrace Deposits”.)

The engineering behaviour of the River Terrace Deposits is mainly dominated by the sand and gravel that it contains. In engineering terms, the River Terrace Deposits comprise a large-grained, non-cohesive soil. With reference to Appendix A, the design of foundations in the River Terrace Deposits is governed by its frictional, rather than cohesive, properties.

The River Terrace Deposits have a relatively high permeability to water. This means that water can percolate relatively easily through this soil. The River Terrace Deposits sit on top of the London Clay. The London Clay is much less permeable to water than are the River Terrace Deposits. Therefore, ground water tends to sit within the River Terrace Deposits, perching on top of the London Clay; rather like an underground puddle, but one in which the water exists in the small gaps between the tightly-packed, individual particles of sand and gravel that make up the River Terrace Deposits. This perched groundwater body is called the Upper Aquifer (Section 3.3.1).

3.2.2 Northern part of the Borough: London Clay

It is important to note that the London Clay underlies the full footprint of the Borough. However, in the southern area, the London Clay is covered over by a blanket of River Terrace Deposits which is sufficiently thick in places that excavations for basements in much of the southern area would not encounter the London Clay.

London Clay is a brown or grey, firm, silty clay. The London Clay developed from a fine sediment that was gradually deposited on the seabed of a tropical sea that covered much of southeastern England between 55 and 52 million years ago. Although nowadays it is present at or near the ground surface, the London Clay has, during its geological history, been buried hundreds of metres below the ground surface. This overmantle material has since been completely eroded. However, its great weight acted to compress and stiffen the London Clay (it is termed an “overconsolidated clay”). In engineering terms, the London Clay is a fine-grained, cohesive soil. With reference to Appendix A, the design of foundations in the London Clay is governed by its cohesive, rather than frictional, properties.

The London Clay has a relatively low permeability to ground water. In essence, the London Clay presents an almost complete barrier to groundwater. In practice, this barrier is not complete: groundwater can permeate slowly through intact London Clay (typically at about

the same speed that human hair grows), and it can move more quickly along any fissures and cracks in the clay, and through localised zones that contain a higher proportion of silts or sands. However, even in the presence of fissures or silty zones, ground water flow rates in the London Clay are significantly slower than in the River Terrace Deposits.

The clayey minerals in the London Clay make it responsive chemically to water. Moisture present within the clay can bond chemically with particles of clay minerals, and cause the particles to swell. The well-known phenomenon of the seasonal swelling (in wet winters) and shrinkage (in dry summers) of London Clay is caused by this chemical bonding.

3.2.3 Local shallow variations: Alluvium and Brickearth

Alluvium is very recently-formed soil (recent in geological time) made from sediments deposited by a river. Alluvium is typically made up of a variety of materials, including fine particles of silt and clay and larger particles of sand and gravel. Alluvium is present in a narrow strip along the eastern edge of the Borough, corresponding to the course of the old river Westbourne. Similarly, another strip of Alluvium is present at Chelsea Creek, at the confluence of the old Counter's Creek with the Thames.

Brickearth was formed from a wind-blown dust that was deposited across Europe under extremely cold, dry conditions. It typically comprises very fine sand, silt and clay particles that are small enough to be carried on the wind. In RBKC, the brickearth is a River Brickearth ("Langley Silt"): the soil particles were picked up and carried by a river from wherever the wind originally deposited them, and then re-deposited by the river at their current location. The thickness of the brickearth layer in the Borough typically varies from 2m to 4 m. As its name suggests, brickearth was traditionally used to make bricks. It is therefore not unusual to find that this commercially useful soil has been quarried, and replaced with backfill material to re-instate the original ground level (Figure 3.4).

3.3 Hydrogeology of the Borough

3.3.1 Groundwater

The groundwater regime across the Borough is generally characterised by two distinct aquifers ("water tables"), which are separated by the relatively impermeable London Clay:

- the Upper Aquifer is perched water sitting in gravelly soils that overlie the London Clay;
- the Lower Aquifer within the sandy soils and chalk that lie deep below the London Clay.

For basements in the Borough, the **Upper Aquifer** is most relevant. This is the water table that would be encountered when digging a basement, and against which the basement has to be designed structurally, and waterproofed. It is also the groundwater table in which, potentially, flow patterns could be interrupted or altered by the presence of basements in the ground (see Section 5.1). In general, the "natural" trend in groundwater flow directions within the Upper Aquifer would originally have tended to be towards the old rivers (Counter's Creek and the Westbourne; Figures 3.2 and 3.5) that previously formed the main tributaries of the Thames in this part of London. However, the urbanisation of London has significantly altered these natural trends. The Westbourne is now contained within the Ranelagh sewer, and the Creek is carried within the Counter's Creek sewer.

The **Lower Aquifer** of the London basin is now mainly present at depth within the Thanet Sand and Chalk. It is an important water resource for London and it is a protected aquifer. From the early C18th, abstraction from deep wells for drinking water and industrial uses caused the groundwater level in the Lower Aquifer to be artificially depressed. This trend continued until the mid-C20th, when industrial demand for water started to dwindle. From the mid 1960s, as the rate of abstraction of water needed by industry in London continued to fall, the groundwater level in the Lower Aquifer began to rise. In principle, if left unchecked, the rising groundwater could regain its natural, pre-industrial levels. In some parts of

London, the pre-industrial water level was above ground surface (that is, artesian conditions). In the late 1990s, a long-term programme of de-watering called the “GARDIT” scheme was established by Thames Water Ltd in association with the Environment Agency in order to remedy the problem. This has started to arrest and reverse the trend of increasing in groundwater levels in the Lower Aquifer. Environment Agency (EA) data issued in June 2007 indicates that the groundwater level in the Lower Aquifer across the Borough is being controlled by the ongoing de-watering scheme, and has been depressed to approximately -30mOD (where mOD denotes metres relative to Ordnance Datum: in essence, this means height from sea level).

3.3.2 Surface water: risk of flooding

Aside from a relatively narrow strip of land close the banks of the River Thames, the elevation of the ground across most of the Borough is well above the levels considered by the Environment Agency to be most vulnerable to tidal surge flooding that could occur if the existing system of tidal defences along the River Thames (such as barriers, walls and embankments) were to be breached by an extreme surge tide event. The Environment Agency gives details of the identified tidal surge flood risk zone at its website at: <http://maps.environment-agency.gov.uk/wiyby/mapController>

Tidal surges can occur when extreme weather events to coincide with high tides. In general, a tidal surge in the Thames that managed to breach flood defences would be manifested as a relatively rapid inundation event, lasting for the duration of the high tide. Properties and basements within the tidal surge zone would be flooded and would typically remain so until the floods waters are pumped out. During a longer-lasting flood event, it is possible that basements outside the flooding visible at-surface could potentially become flooded through seepage below ground. This situation would be more likely to arise in areas that have highly permeable soils (such as gravel), which is the soil type that is most prevalent in the southern part of the Borough, closest to the Thames.

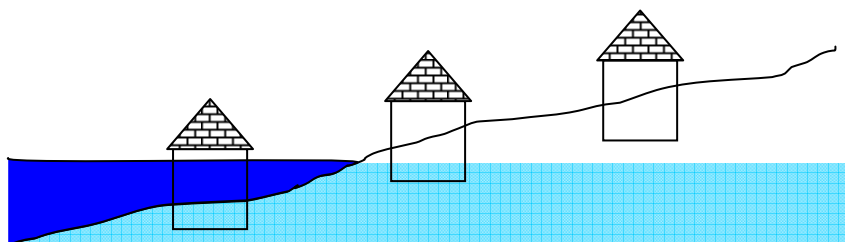

During recorded flood events in London (whether caused by, for example, localised ponding in low-lying areas after excessive rainfall, sewer failures, burst water mains *etc.*) the flooding of basements is usually most common in traditionally-built, brick-lined cellars that have not been waterproofed or “tanked”, or where surface flood waters can enter through skylights. In general, modern engineered basements are generally designed to exclude ground water as much as possible, and so are usually less prone to flooding in such situations.

Since May 2007, the Environment Agency (EA) has required all homeowners in flood risk zones who wish to extend or build a basement to provide a flood risk assessment (FRA). The EA requires that it be consulted before a borough council can grant planning permission for a basement in a flood risk area. This is discussed further in Section 6.4.7.

A Strategic Flood Risk Assessment (SFRA)¹ of the Borough has recently been undertaken on behalf of RBKC jointly with the neighbouring London Borough of Hammersmith & Fulham (LBHF). Reference should be made to the joint RBKC/LBHF SFRA report for fuller

¹ Strategic Flood Risk Assessment: Final Report – the Royal Borough of Kensington and Chelsea and the London Borough of Hammersmith and Fulham; JBA Consulting; July 2007

discussion of flood risk issues and strategies within the Borough and for flood risk maps for the Borough, which are not reproduced here.

4 Planning applications for residential basements in the Borough

4.1 Introduction

As part of this scoping study, RBKC has made available to Arup a spreadsheet listing the planning applications received by the Borough's Planning Office that involved basement developments in residential properties between January 2001 and June 2007. The list included 235 planning applications for new basements and basement extensions. It is understood that the list was compiled from the RBKC master list of planning applications by searching for the word "basement" and the relevant UDP Planning Guidance clause number ("CD32"). It is therefore possible that perhaps some relevant applications may have been overlooked but, if so, the quantity omitted would be likely to be insignificant for the purposes of this scoping study.

4.2 Overview of data

The key data reviewed by Arup in the spreadsheet were:

- the case year date;
- postcode of the property;
- summary of proposed works;
- location of works within the property;
- planning decision made.

Tables 1 to 4 summarise various aspects of the basement planning applications for residential properties in the Borough in the period from January 2001 to June 2007. The map in Figure 4.1 shows the locations of the properties for which applications for residential basement developments were made during this period, based on postcode information.

Key trends from the reviewed data are:

- After relative stability in the number of applications made annually in the Borough during the period 2001 to 2005, there was a surge-like doubling of applications in 2006, relative to the annual rate of applications in each of the 4 preceding years.
- Most planning applications did not state the intended purpose of the basement;
- Of those applications that did state the intended purpose of the new basement space, most were for swimming pools, recreational and living spaces. Very few applications were stated to be for car parking (only 1 application in the 6 year period).
- The number of applications for basement developments under rear gardens is similar to – indeed slightly higher than – the number of applications for basement developments under houses. Together, these two categories comprise the majority of applications received by the Borough.

4.3 Observations on the incidence of basement applications

4.3.1 Overall clustering of applications

Figure 4.1 shows the map of residential properties in the Borough for which subterranean development planning applications were made in the period 2001-2007.

There is evidently some spatial clustering of basement applications in the Borough. Going from south to north across the Borough, four distinct zones can be identified (Figure 4.2):

- **Zone A** extending from the River Thames and just north of Brompton Road, which includes Chelsea and Brompton: within this southernmost part of the Borough, there was a relatively high number of planning applications for residential basement developments in the period 2001 and 2007;
- **Zone B** extending from just north of Brompton Road to just north of Cromwell Road, and including within it South Kensington's "museum district" and Earl's Court: there were no planning applications for residential basement developments in this area between 2001 to 2007;
- **Zone C** extending from just north of Cromwell Road to, approximately, an imaginary line stretching from Holland Park Underground Station in the west and Westbourne Park Road in the east, and including within it Kensington, Holland Park and parts of Notting Hill: in this central part of the Borough, there was a relatively high number of applications for residential basement developments;
- **Zone D** approximately defined as the area between the line from Holland Park Station /Westbourne Park Road, and the northern boundary of the Borough at Kensall Green: in this northernmost part of the Borough, there were some - but not many - planning applications for residential basement planning.

Thus the majority of planning applications for residential basements were in and around Chelsea (Zone A, as defined above) and Kensington (Zone C, as defined above).

4.3.2 Local groupings of applications

Looking in closer detail at Figure 4.2, it is evident that within the two main clusters of basement planning applications in the Borough (labelled Zones A and C in Figure 4.2) there are some locally denser groupings of basement applications. For discussion purposes, Figure 4.2 highlights three such dense groupings in the Chelsea area (Zone A). These dense groupings represent planning applications for basements in several different residences within a given street.

Examination of individual house numbers listed in the spreadsheet provided by RBKC reveals that some of the dense groupings involve series of properties that are immediately adjacent to each other. (It has been assumed that the houses are numbered in the traditional odd/even sequence on each side of the road.) Specifically, from the planning application summary data provided by RBKC for the period 2001-2007:

- there are three streets in the Borough that contain "runs" of three adjacent houses all with planning permission for basement works (that is, a pattern of 1 / 1 / 1 applications in each of these three streets)
- within one street that contains semi-detached houses, there is a "run" of two pairs of houses that each have planning permission and which are separated by a house that does not have such permission (that is, the pattern is 1 / 1 / 0 / 1 / 1 applications)

These close adjacencies still represent relatively unusual groupings within the Borough, but it is noteworthy that such adjacencies have already arisen in practice in some areas. They therefore constitute realistic scenarios, not hypothetical situations, which should be discussed and considered when developing a planning strategy for subterranean development in the Borough.

4.3.3 Distribution of planning applications compared with shallow geology

Figure 4.3 shows that the majority of applications for residential basement developments in the Borough during the period 2001-2007 lie within the southern, gravelly soil zone (the River Terrace Deposits). However, this majority is likely to be because this soil type covers a greater proportion of the land area in the Borough than does the London Clay soil zone. Even allowing for its smaller footprint, a substantial number of basement planning

applications lie within the London Clay zone, particularly in the area just north of Holland Park. It therefore appears that local soil type has not influenced decisions by individual householders of whether to apply for subterranean developments, and that basements have been developed in both types of ground.

Table 1: Number of residential basement applications submitted per year

Year of planning application to RBKC	Number of applications received during the year
2001	13
2002	29
2003	27
2004	36
2005	36
2006	67
2007 (to June)	27

Table 2: Stated purposes of new residential basements (Jan 2001- June 2007)

Purpose of basement stated in planning application to RBKC	Number of applications
Swimming pools	26
Recreation (gym etc.)	23
Living space	20
Utility rooms / storage	15
Car parking	1
Not stated	150

Table 3: Positions of basements within the property (Jan 2001- June 2007)

Position of basement within property, stated in planning application to RBKC	Number of applications
Under rear garden	94
Under main building (the house)	90
Under front garden	41
Under car parking area / garage	5
Under house, front and rear gardens	4
Under public area	1

Table 4: Residential basement applications refused/granted (Jan 2001- June 2007)

Planning decision by RBKC	Number of applications
Granted	219
Refused	16

5 Discussion of the main effects of basements

5.1 Underground water

In the City of London (the Square Mile), the natural, near-surface geology is very similar to that present under much of the Royal Borough of Kensington and Chelsea, with River Terrace Deposits overlying London Clay. In and around the City, the pressure on available real estate has meant that the installation of large basements has been the norm since the post-war period. Even earlier than this, most bank buildings had basements as this offered greater security for vaults and storage. Across swathes of the City, the basements of adjoining buildings touch their neighbours such that there is little or no soil left in the ground down to the depth of the basements, which typically extend as deep as the upper part of the London Clay. In such areas, the only remaining shallow, permeable soil exists underneath the roadways.

The large-scale removal of the River Terrace Deposits (the gravelly, water-permeable soils that overlie the relatively impermeable London Clay; Section 3.2.1) from the City has not caused significant problems associated with localised “damming” in the shallow groundwater table. The groundwater, where it is present and if it is moving, simply finds another route if it becomes “blocked” by a subterranean structure at a particular location, although there may be local rises in level. In the City, this alternate route for groundwater flow is under the roads. Where the groundwater in the Upper Aquifer is indeed moving – rather than being a static puddle – the flow rates tend to be slow and modest. The urbanisation of London has significantly altered ground water levels in the Upper Aquifer and the natural trends and directions of flow within this aquifer. For example, the construction of Joseph Bazalgette’s intercept sewers along the embankments of the Thames; and, locally in the Borough, the corralling of the Westbourne and Counter’s Creek into sewers; the sealing-off to rainfall of the ground surface by pavements and buildings; and leakage from water mains and sewers have all acted to alter groundwater levels and flow regimes.

Within the upper surface of the London Clay, localised ancient river channels are sometimes encountered. These exist as incised grooves in the upper surface of the clay layer, and are typically infilled with relatively permeable River Terrace Deposit material. Groundwater tends to accumulate in these features, because they act as low-lying sumps. The water in a buried channel may or may not flow, depending on whether the channel connects with other such features. If it does flow, the flow rate is likely to be slow. If an incised channel of this type is encountered during subterranean development works, it could present particular challenges for a contractor who is building a basement using the underpinning method. This is because it would be more difficult to excavate safely the soil at each underpin (significant pumping would be needed), and because the surface of the London Clay would be locally deeper than may have been anticipated at the design stage, unless the ground investigation for the project included exploratory boreholes that intersected the channel. Once the basement sidewalls had been formed across the channel, forming a seal or obstruction, the groundwater within the soil in the channel would cease to flow (if it had indeed flowed previously) in that direction, and another preferential flow route elsewhere in the ground would take over.

If mobile groundwater in the Upper Aquifer were forced to find an alternative flow route past an underground obstruction, that could potentially cause the groundwater level within the zone encompassed by the new flow route to increase locally. For an existing cellar within that zone, if the cellar was not suitably protected (“tanked”) against groundwater ingress, then the degree of dampness or seepage into the basement may potentially increase. For

natural springs², of which there are several recorded in the Borough, the rate of water flow from the spring may increase. The level of the water table within the Upper Aquifer varies and is not naturally static: variations in the water table are mainly associated with seasonal changes in rainfall and in plant transpiration rates (water uptake by plants) as well as extreme weather events, and other factors such as pipe bursts and sewer leakage. Any assessment of potential changes in ground water level that may be associated with a specific subterranean development should therefore be viewed in the context of the local ambient variations. It is likely that a cellar or spring may already have experienced greater groundwater levels on frequent occasions in the past.

Given the importance of groundwater to the wellbeing of trees, it is informative to consider a situation in which every property around the four sides of a garden square on the River Terrace Deposits has a basement that extends as deep as the top of the London Clay, and that all the properties are terraced. That would mean that the only remaining underground routes for groundwater to flow into the garden square would be the “fingers” of gravelly soil that remained under the roads leading into the square. Would this have an adverse impact on the trees? Rainwater would still fall onto the ground surface, which, being grassed rather than paved, should allow the rainwater to percolate into the soil. In periods of low rainfall, trees rely more heavily on water stored within the Upper Aquifer. The fingers of soil that remain under the roads would allow this aquifer to be gradually recharged with groundwater from outside the square, and this would be augmented by any leaks from pipes and sewers within the square. It is important to recognise that the situation of the terraced square on the River Terrace Deposits is arguably better than that of any garden on the London Clay. For gardens on the London Clay, such as those in the north of the Borough, the Upper Aquifer is absent and therefore trees and plants must rely on moisture within the clay. This soil moisture can only be recharged by infiltration by rainfall, irrigation or subsurface leaks from mains and sewers.

It is understood that, within the Borough, it has been suggested that it may be useful to require subterranean developers to leave a buffer of soil between adjacent basements, in order to enable groundwater to flow around and between individual basements. As described above, this provision is unlikely to be necessary, as the groundwater in the Upper Aquifer can tend to find an alternate route, even under obstructions as large as entire city “blocks”. Moreover, the provision of a soil buffer between a pair of basement walls on either side of a party wall is likely to increase the structural difficulty of, and hence the risks associated with, supporting the party wall.

5.2 Surrounding buildings

This section considers the potential effects of subterranean developments on nearby structures and infrastructure. In the extreme case, a building may directly adjoin another structure and the two properties may share a common party wall. In other situations, the neighbouring structures may not abut the building of interest, but may still lie within the potential halo of influence of subterranean development works at that building.

Before the works: pre-condition surveys

The following sub-sections describe various situations in which, if they are not successfully avoided by the appropriate planning, design and execution of subterranean development works, could potentially cause damage to neighbouring structures. Such damage could include cracking, or perhaps more severe structural damage. In practice, it is often difficult to attribute cracks visible in a structure to specific site construction activities unless a detailed survey of the affected structure had been undertaken before the construction works

² A spring is a geological feature formed where the interface between a permeable soil, such as gravel, overlying an impermeable soil, such as clay, intersects a hillside, and where groundwater in the permeable soil flows out at the ground surface.

started, and then is repeated after the works are complete. Any observed changes in the state of the building can then be causally linked to the works with more confidence and less debate than if no pre-works condition survey had been undertaken. Surveys require the cooperation of the property owner, as entry by surveyors into the property is usually necessary.

During the works: temporary changes in foundation capacity

The foundations of a structure transfer the load from the building to the ground. In general terms, foundations serve two purposes: to spread the load of the building over a wide area, so that the ground is able to bear it without failing; and to reduce the settlement of the ground beneath the building, which may otherwise damage the structure above.

The load bearing capacity of a foundation is determined by the mechanical characteristics of the soil, the geometry, size and depth of the foundation, and the conditions of the immediate vicinity of the foundation (see Appendix A). Underpinning works require the exposure of the existing foundation, which means that on at least one side of the foundation, the soil between the foundation toe level and the original ground level must be removed. This will cause a temporary reduction in the bearing capacity of the foundation, because the self-weight of the removed soil (the "overburden") no longer contributes to the bearing capacity of the foundation (Appendix A). The temporary, localised loss of part of the bearing capacity of the building foundations does not mean that the foundations would fail - although that is a possibility unless the works are properly planned, designed and executed in order to mitigate the temporary, localised reduction in the bearing capacities of the foundations. A common and simple method of mitigation used in underpinning works is the use of "hit and miss" excavations, in which the length of foundation along which the overburden is to be temporarily removed is kept as short and localised as possible (Section 2.2.1.2 and Figure 2.1). With reference to Appendix A, the adverse effect of the temporary loss of overburden is more significant in gravelly soil than in clay. Particular care is therefore required when removing overburden adjacent to footings in gravel soil areas.

Underpinning of shared party walls is a frequent engineering activity: the technique is widely and successfully used under both large and small structures. The issue of temporary, localised reduction of foundation bearing capacity can be mitigated by careful prior planning, by undertaking detailed and relevant design analyses and, perhaps most importantly, by good quality workmanship on site.

During the works: ground movements

Excavations will always cause some movement in the surrounding ground. A subterranean development that is poorly designed and/or constructed would tend to cause greater ground movement and, hence, have greater potential impact on adjacent structures and infrastructure than would a well-planned, well-designed and well-executed scheme for which ground movements have been minimised and controlled. Depending on the specific circumstances and method of working on site, ground movements can be controlled and limited by, for example: carrying out the work in gradual, piecemeal steps; using temporary props and struts to support the excavation; and using support from the permanent structure. Generally, ground movements are typically higher in cases where less care is taken in providing suitable support to the excavation.

After the works: change in stiffness of foundations

A new basement or basement extension built under an existing structure will have deeper and hence, usually, will have stiffer foundations when loaded than that building's original foundations. For a pair of adjacent properties (semi-detached or terraced) that directly share a party wall, it is important that both the engineering designer and contractor consider how the deepening of the foundations of the party wall could perhaps affect the structure on

the other side of the wall. The mitigation of this potential hazard will be site- and project-specific, depending on the structures involved and their geometry and layout.

After the works: change in depth of the foundations

The new foundations of a subterranean development under an existing structure will be deeper than that building's original foundations. For structures on London Clay, the problem of seasonal ground settlement (in dry summers) and ground heave (in wet winters) is most commonly addressed by deepening foundations so that they extend well below the shallow clay that is most prone to seasonal wetting and drying. Adding a basement to a detached property founded on clayey soil is therefore an attractive way of tackling the problem of subsidence on clay. In the case of a pair of adjacent properties (semi-detached or terraced) that directly share a party wall in a clay soil area, it is important that both the engineering designer and contractor consider how the deepening of the foundations of the party wall could perhaps affect the structure on the other side of the wall. The mitigation of this potential hazard will be site- and project-specific, depending on the structures involved and their geometry and layout.

5.3 Sustainability and legacy

A detailed, whole life analysis of the "environmental footprint" of subterranean developments is not within the scope of this report: the environmental impact of subterranean developments should be reviewed in the light of the Borough's Environmental Strategy. The following environmental and sustainability issues are highlighted here:

- The excavated spoil is likely to be "made ground" (soil containing debris such as broken bricks, ash, glass etc. associated with human habitation) rather than inert natural soil, so would have to be disposed of at a suitable landfill site as, typically, non-inert waste;
- Deliveries to and from the construction site will be via lorries, including vehicles needed to remove the excavated spoil and take it to landfill sites. Basement projects usually generate much greater volumes of spoil per cubic volume of new building created than is the case for above-ground structures;
- Most subterranean structures are built using concrete, which has a relatively high carbon dioxide (CO₂) emission rating. Carbon dioxide is one of the "greenhouse gases" that have been linked to climate change, and for which reductions in emissions have been targeted by the UK government under the Kyoto protocol and additional national goals;
- Subterranean developments under gardens and other green spaces reduce the available land surface area through which rainfall can percolate into the ground to re-charge the Upper Aquifer (water table);
- The "made ground" and the River Terrace Gravels are the soil layers that typically contain most archaeological artefacts. These soil layers and any artefacts they contain will be excavated and removed as part of subterranean developments;
- Most archaeological discoveries in London have been as a result of construction works: subterranean developments therefore represent a means of increasing knowledge and understanding of the archaeology in the Borough.
- Subterranean developments under existing buildings increase the usable floor area available within the Borough, without taking new land or increasing the skyline profile;
- Basement developments change the nature of the building stock in the Borough, although aside from the installation of basement skylights at the front of buildings, these changes are not usually readily visible from the exterior of the property.

5.4 Nuisance caused during works

The main forms of nuisance and disturbance during basement works are:

- Noise and vibration;
- Dust;
- Visual impact;
- Obstruction of pavements (partial or complete);
- Bringing excavated spoil up to awaiting skips/vehicles;
- Transporting the spoil away from the site, using local roads;
- Delivery of construction materials to the site.

In general, these effects are at least of similar, and sometimes of greater, magnitude than equivalent categories of disturbance created by other types of residential building works (such as replacing a roof, converting a loft, or adding a conservatory).

In residential areas, particularly in terraced streets, noise and vibration from construction works can be of particular concern to local residents. Behavioural studies have shown that people in their own homes are much less tolerant of noise and vibration than, say, office workers in their place of business. Similarly, people are much less tolerant of noise at night than in the daytime, and less tolerant of unexpected, intermittent noises than of anticipated, regular sounds. These psychological differences underlie the various British Standards³ that give guidance on the noise and vibration limits acceptable to humans.

5.5 Safety during the works

It is important to consider the health and safety risks that are associated with underpinning works of the type that is frequently used to form basements, especially when underpinning historical structures that were not constructed to modern engineering standards.

A relevant example is the case in February 2001 in which a construction worker was killed during the refurbishment of St. Mary's Church, Bryanstone Square, Westminster, W1. The work at St. Mary's included lowering the crypt floor and underpinning the existing foundations. During the underpinning, a 1.5 tonne section of masonry fell from the underside of an unsupported wall, hitting the operative working within the excavation. The Health & Safety Executive (HSE) successfully prosecuted both the structural engineer and principal contractor for various breaches of health and safety legislation. A summary of the prosecution is presented on the HSE website at www.hse.gov.uk/press/2005/e05016.htm. The HSE inspector commented that:

"[the incident] could have easily been avoided, had appropriate and straight forward safety measures been in place... [it] came about through the failure to take appropriate action in relation to a potential risk in the underpinning work, that had been brought to the attention of both the structural engineer and the contractors. The possible risks should have been addressed by uncomplicated measures including a detailed structural investigation, suitable and sufficient risk assessments and adequate protective measures, such as propping of the foundations."

The HSE's comments on this case indicate that underpinning can be undertaken safely, provided that appropriate engineering and safety measures are planned and carried out.

³ British Standards Institution (1985) BS 6611: *Evaluation of the response of occupants of fixed structures, especially buildings and offshore structures, to low frequency horizontal motion*. BSI London.
British Standards Institution (1987) BS 6841: *Measurement and evaluation of human exposure to whole-body mechanical vibration and repeated shock*. BSI London.
British Standards Institution (1992) BS 6472: *Evaluation of human exposure to vibration in buildings*. BSI London.

5.6 Hazards to passers-by

A contractor should treat the health and safety of the public as well as site workers as an integral part of his work planning, not as an afterthought: indeed, this attitude is often a useful indicator of general professional competency. Potential hazards to passers-by include: vehicle movements; deliveries (especially when these must be carried across the footway); dust and debris; blocking the pavement; trip hazards; open deep excavations; objects falling from lifting hoists. Methods of mitigating these potential hazards include the use of protective hoardings, appropriate signage and warnings, and controlling at-street work activities especially deliveries and lifting operations.

Contractors should have in place appropriate public liability insurance.

6 The planning context for basements

6.1 UDP

The current Unitary Development Plan (UDP) that applies in the Borough was introduced in 2002, and has been amended occasionally since then. The UDP includes several clauses that relate directly or indirectly to subterranean development, and specifically to the control of such development. Extracts of the relevant clauses from the UDP, which are mainly from the Borough's policies relating to conservation and development ("CD"), are reproduced below:

UDP 2002 Clause CD24 (page 62)

"CD24 To resist development in, on, over or under garden squares, in order to protect their special character..."

UDP 2002 Clause CD32 (page 68)

"CD32 To resist subterranean developments where:

- a) the amenity of adjoining properties would be materially affected; or*
- b) there would be a material loss of open space; or*
- c) the structural stability of adjoining or adjacent listed buildings or unlisted buildings within conservation areas might be put at risk; or*
- d) a satisfactory scheme of landscaping including adequate soil depth has not been provided; or*
- e) there would be a loss of trees of townscape or amenity value.*
- f) there would be a loss of important archaeological remains"*

UDP 2002 Clauses CD80 and CD83 (pages 94/95)

"CD80 To resist development proposals that would result in unnecessary damage or loss of trees"

"CD83 To require where practicable an appropriate replacement for any tree that is felled"

6.2 LDF: public consultation

As part of the preparations for the new Local Development Framework (LDF), which will replace the UDP, the Borough undertook a public consultation to gauge priorities and identify issues of concern to people in the Borough. The results of the consultation were published in July 2006 in the report *"RBKC Local Development Framework: Issues and Options Consultation (November/December 2005)"*.

Under the heading "Conservation and Development" (page 38 in the July 2006 report) asked respondents to comment on the following question: *"Subterranean development: what should the Council's approach be to subterranean development?"*. The tick-box responses were, expressed in numbers of replies:

- | | |
|--|-----------|
| ▪ Resist all subterranean development: | 18 agreed |
| ▪ Resist subterranean development unless particular criteria can be satisfied: | 59 agreed |
| ▪ Permit subterranean development as it assists people to adapt their homes to changing needs and remain in the borough: | 37 agreed |
| ▪ No views or don't know: | 9 replies |

Thus 15% of the respondents who took an active part in the consultation were wholly against subterranean development in the Borough, and 78% were in favour of allowing subterranean development, albeit subject to certain controls and limits.

In the 31 written responses received on the topic, three main themes emerged:

- **Environmental concerns:** adverse effects on the water table, drainage and water run-off, as well as damage to trees and loss of gardens.
- **Structural issues:** including direct structural damage, and indirect damage caused by subsidence on London Clay associated with changes in its water content.
- **Criteria for development:** including the definition of criteria and prescriptive controls on subterranean development.

6.3 LDF: mechanisms under the new framework

The new Local Development Framework (LDF) for the Borough, which is currently being developed, will be in the form of a “portfolio” of documents, the broad scope of which is formally prescribed by central government. Amongst these documents will be the Proposals Map. This map is the mechanism by which any geographically or spatially-variant policies within the Borough will be expressed.

6.4 Other consent processes and constraints

There are other mechanisms by which subterranean development schemes can be scrutinised, amended, improved, curtailed, controlled or refused. These include:

- Listed building consent
- Conservation area consent
- Planning application documentation
- The Building Regulations (operating through Building Control)
- The Party Wall Act
- The Construction (Design and Management) Act
- The Control of Pollution Act
- Flood risk areas
- Protection of trees (Tree Preservation Orders)
- Preserving rights of way.

6.4.1 Listed buildings, Conservation areas & Garden Squares

The Borough contains numerous Grade listed buildings that are nationally recognised by English Heritage as being of exceptional character and interest (Figure 6.1). These structures would be subject to listed building consent if it were proposed to modify the building by adding or extending a basement. Moreover, structures lying within the curtilage of listed buildings may also be subject to listed building consent. “Curtilage” is a somewhat vaguely defined term, but it can include direct adjacency (abutting structures). It is appropriate to note that, in practice, permission to work on or alter Grade II listed structures is not often refused by English Heritage: approximately nine in every ten applications to undertake building works in Grade II listed structures receive approval.

The Borough includes 35 defined Conservation Areas, which in total encompass approximately 70% of the land area in the Borough (Figure 6.2). Particular constraints apply to developments in the Conservation Areas, which are detailed in the UDP (Section 6.1).

The Borough includes more than a hundred garden squares. Approximately half of the squares (Figure 6.3) are managed and maintained by garden committees formed under the Kensington Improvement Act (1851) or the Town Gardens Protection Act (1863). Many of the Borough's garden squares are included in English Heritage's *Register of Parks and Gardens of special historic interest in England* (as compiled under the Historic Buildings and Ancient Monuments Act (1953) and the National Heritage Act (1983)). Special constraints apply to developments in garden squares in the Borough, and are detailed in the UDP (Section 6.1).

6.4.2 Building Control

In assessing a planning application, a Local Authority Planning Officer must tacitly assume that the engineering design will be professional and competent, that the construction works will be undertaken in a skilful and proficient manner, and that the sequence of working on site (including the "temporary works", for example the temporary propping and support of an excavation whilst the final permanent walls and slabs are being installed) will be properly planned and carried out. A Planning Officer cannot refuse a planning application on the basis that these standards may not be met in practice. However, this issue is a relevant factor to consider when developing future planning policy on subterranean development because it frequently lies at the root of concerns and worries that residents may have when a neighbour applies for permission to develop a basement.

Issues associated with engineering design details, on-site operations, safe working and, in the broadest sense, standards of workmanship in construction come within the remit of Building Control. The Building Control body certifies whether works are in accordance with the Building Regulations. In addition to reviewing and approving design plans, the role of Building Control officers includes on-site inspections to view works and assess public safety.

6.4.3 Planning submissions to the RBKC Planning Office: method statements

In the Royal Borough of Kensington and Chelsea, applicants seeking planning consent for subterranean developments are notified by letter from the Borough that a structural method statement must accompany the application papers:

"On submission of a formal application, the Council will require a comprehensive method statement that includes:

- *Borehole tests/soil test results*
- *Construction drawings*
- *Construction calculations*
- *Structural Engineer's written report.*

The information is required at the planning application stage to provide evidence that the implications of ... proposals for the structural stability of neighbouring properties has been taken into full account. This information will be included with the application documents and will be available for inspection by members of the public and any interested party."

In addition to enabling both the applicant and neighbours to understand how the all-important issue of structural stability has been addressed in the proposed design, a key advantage of the requirement by the Borough that method statements be supplied is that the early involvement by an engineer should help site-specific challenges and risks to be identified and mitigated at an early stage in the subterranean development project.

A practical disadvantage of the Borough's requirement that method statements be supplied arises for the Planning Office itself, because it involves the office in disproportionately more time and expense when handling applications for subterranean developments than for other types of planning application. Nevertheless, if the current requirement is kept in place in future, then it is important that facilities are available to scrutinise and assess the submitted

method statements, so that the submission does not become a “paper exercise” but instead genuinely represents an in-depth review by an experienced engineer of the site-specific and project-specific issues relevant to that project.

If the Borough decides to keep in place the requirement that a technical method statement be submitted alongside any planning application for subterranean development, then one option for the Borough to consider is to require that the applicant’s structural engineer should formally sign-off as reasonable the submitted method statement in its entirety. This would mean that the Council’s own staff should not then need to undertake or commission their own detailed, in-depth technical review of the method statement, as the document would already have been checked and signed-off as being reasonable by an engineer.

It is appropriate to highlight that the term “Structural Engineer” (even when capitalised) does not imply any formally recognised professional qualification. Unlike doctors and architects, the title “engineer” is not protected in the UK. However, the terms **Chartered Engineer** (CEng) and **Chartered Structural Engineer** are protected professional titles. In particular, Chartered Structural Engineer denotes membership of the Institution of Structural Engineers (MIStructE), which indicates that the holder has attained a certified level of professional and technical competency in the specialist field of structural engineering.

6.4.4 Party Wall Act

For basement developments in densely built urban areas, the Party Wall *etc* Act (1996) will usually apply because neighbouring houses would typically lie within a defined geometrical “halo” around the proposed basement works. (Specifically, the Party Wall Act applies to any excavation that is within 3m of a neighbouring structure; or that would extend deeper than that structure’s foundations; or which is within 6m of the neighbouring structure and which also lies within a zone defined by a 45° line from that structure.) Under the Act, the building owner – that is, the person who wishes to undertake the basement works – is required to notify any neighbours likely to be affected by the proposed works, including a description of what is intended to be done. The notice must include details of whether/how the foundations of neighbouring buildings would be strengthened or safeguarded. The neighbour has certain rights to dispute the proposed works, and the Act gives details of these and the formal process that must be followed. The neighbour (who is called the “Adjoining Owner” under the Act) has the right, amongst other things, to:

- Require reasonable measures to be taken to protect their property from damage that is foreseeable;
- Not undergo unnecessary inconvenience;
- Be compensated for loss or damage caused by the works;
- Request secured expenses to be set aside to cover the risk that the work may be left incomplete, particularly if the stoppage were to happen at a “difficult” stage in the temporary works when an excavation may be most vulnerable to potential collapse.

6.4.5 CDM Regulations (2007)

The Construction (Design and Management) Regulations of 2007 is intended to help improve health and safety during the construction, operation, maintenance and eventual demolition of structures. The CDM Regulations apply in part to all construction projects, and in full to all business-based construction projects that will last longer than 30 days on site or will take more than 500 man-days to complete. Commercial basement projects usually last several months, and so are invariably governed by the full requirements of CDM. However, construction work for “domestic” clients does not come fully under the Regulations. A domestic client is someone who lives, or will live, in the premises where the construction work is being done, and these premises are not connected with any trade or business.

A key element of CDM is the requirement that a commercial client must ensure that only competent, experienced organisations are employed to undertake the works. Another aspect of CDM is that it requires clear design responsibility. In terms of basement projects in an urban setting, both these requirements under the CDM regulations are particularly valuable, because the specific challenges and complexities of forming basements mean that only experienced designers and constructors should undertake such work.

6.4.6 Control of Pollution Act (1974)

Sections 60 and 61 of the Control of Pollution Act (1974) gives local authorities powers for controlling noise and vibration from construction sites. Under this Act, a local authority can, amongst other things, specify or prevent the use of certain machinery, restrict working hours, and specify the maximum permitted noise and vibration levels emanating from the construction site. It can apply these powers before construction works start: the aim of this is to help ensure that issues can be pre-emptively sorted out before work starts.

6.4.7 Flood risk

In December 2006, Planning Policy Statement 25 (PPS25; Development and Flood Risk) was introduced. It presents Governmental policy on development in relation to flood risk. Under PPS25, flood risk should be accounted for at all stages in the planning process. The Environment Agency (EA) requires all homeowners in a flood risk zone who wish to extend or build a basement to provide a flood risk assessment (FRA). The EA requires that it be consulted before a local authority can grant planning permission for a basement development that is located within a flood risk area.

6.4.8 Tree preservation orders (TPO)

The applicable law on tree preservation orders (TPOs) is the Town & Country Planning Act (1990) and the associated regulations presented in the Town & Country Planning (Trees) Regulations (1999). A TPO is made by the local planning authority, and it can be used to prohibit the felling, uprooting, topping, lopping, or wilful damage or destruction of a tree protected by an Order. "Lopping" is formally interpreted as including the cutting of roots.

TPOs are potentially relevant when considering planning applications for subterranean developments in some circumstances, particularly public spaces. However, in general, trees that are located in back gardens, especially of private residences, are rarely the subject of TPOs. Therefore, TPOs are not generally pertinent to residential applications for subterranean development.

6.4.9 Rights of way

For many properties in England that are located next to a highway, the land lying underneath the road, up to its centre line, is within the legal boundary of that property. Nevertheless, the existence of the right of way at the ground surface invariably precludes any subterranean development below the road. Most basement developments therefore remain inside the physical boundary of a property (that is, inside the fence line or similar that, in daily life, is usually taken to define the edge of a property).

During construction works for basements in small properties, especially those with no garden at the front or side, the workspace needed to accommodate deliveries, access ramps, skips *etc.* may potentially have to overspill into the public highway space. In such cases, permission to temporarily block or impede access along the highway (including the footway) would have to be obtained from the relevant authority. The relevant authority is often the Borough but, in some locations, it is Transport for London (TfL).

7 Conclusions of Phase 1 scoping study

This report has presented the results of the Phase 1 scoping study undertaken by Arup on behalf of the Royal Borough of Kensington and Chelsea. The aims of the scoping study are to identify and assess the likely importance of factors and issues considered to be potentially relevant to planning policies for subterranean development in the Borough. Given that the current Unitary Development Plan (UDP) is soon to be replaced by the new Local Development Framework (LDF), the scoping study has looked ahead to how subterranean development could be addressed within the LDF.

The following points summarise the key conclusions of the scoping study:

1. Subterranean development in the Borough cannot be viewed in isolation from other planning issues, including for example: the protection of heritage structures, archaeology, and conservation areas; environmental protection; requirements for sustainable development; the need for provision of additional housing; the risk of flooding *etc.* The present UDP includes several planning policies which, although not explicitly concerned with subterranean development, impinge upon it indirectly (Section 6.1).
2. Clause CD32 of the UDP (2002, page 68) deals explicitly with subterranean development in the Borough. The provisions of CD32 encompass: the effect on the amenity of neighbouring properties; landscaping and adequacy of reinstated soil depth; loss of open space; loss of trees; loss of important archaeological remains; and the structural stability of buildings, but only within conservation areas. Assuming that these or similar general provisions are carried forward to the new LDF in some format, it is appropriate to note that Clause CD32(c) in the UDP relates to the structural stability of buildings in conservation areas only. In the Borough, the conservation areas cover almost 70% of the total land area, and so Clause CD32(c) includes many if not most properties in the Borough. However, it is unclear why structural stability only within the conservation areas is explicitly covered, because occupants as well as buildings could be put at potential risk if a major collapse were ever to occur during subterranean development works.
3. The public consultation process on subterranean development in the Borough undertaken during this scoping study indicated that the potential impact of subterranean developments on groundwater levels and groundwater flows is a subject of concern for many people. The scale and extent of such impacts will be site-specific, and will depend very much on a combination of local, site-specific factors acting together such as soil types, underground topography (the shapes of the interfaces between different soil layers) and the existing pattern of ground water flows within the local area. In general, where the sub-surface conditions are not unusually adverse, flowing groundwater will usually simply find an alternative route when it meets an underground obstruction, and static groundwater will re-distribute itself. It is therefore likely that, in general, the effect of a new basement on groundwater levels will be relatively small, and may be less significant than natural seasonal or other variations in the groundwater table. Both groundwater levels and groundwater flows are factors that competent basement design engineers and contractors should take into account in their work, as each affects the technical design and practical construction of a basement.
4. Concerns about the potential for structural damage if subterranean development works are not undertaken properly were also prominent in the public consultation undertaken during this scoping study. Subterranean development in a dense urban environment, especially basements built under existing structures, is a significantly more challenging

engineering endeavour than most other forms of urban construction except, perhaps, major renovations involving the partial demolition of structures. In particular, there is a genuine potential risk of damage to neighbouring structures and infrastructure if excessive ground movements occur around an ill-planned or poorly-implemented subterranean development. On the other hand, subterranean developments have been successfully achieved in London and elsewhere over many years. In general these successful projects have been undertaken by experienced, competent teams who recognised the potential hazards and mitigated against them.

5. These observations suggest that it is perhaps appropriate that different, stricter planning requirements and safeguards be considered for subterranean developments than for other types of building works in the Borough. If such a distinction were to be adopted by the Borough, then an underlying aim of the subterranean development planning requirements should be to encourage clients of subterranean development projects to ensure that the firms they engage for such works are competent and experienced, and that such firms are involved in the project from the outset. The “works” should be taken as encompassing the full spectrum of activities from project inception to completion, including for example: initial surveys and site investigations, the engineering concept and design, the specification of the construction works, planning the sequencing of site works, the quality of construction workmanship on site, and quality of materials. All stages in the works process, from initial surveys to structural completion, are important and should be undertaken competently.
6. Aspects of the design issues for subterranean developments under semi-detached or terraced properties that directly share a common party wall with neighbour(s) differ in several ways from subterranean developments under fully-detached properties that are not close to other structures. Aside from owner-occupiers’ natural concerns about noise, vibration and general inconvenience when their neighbours “have the builders in”, there are also engineering design issues specific to subterranean developments alongside such party walls. These engineering issues are described in more detail in Section 5.2 under the sub-headings *Change in stiffness of foundations* and *Change in depth of foundations*. These engineering challenges can be successfully addressed and mitigated in practice, and would not necessarily preclude a subterranean development under a non-detached property, but it is appropriate for the Council consider whether explicit additional provision should be made in the LDF planning requirements for subterranean developments adjacent to shared party walls. At present under the UDP, the Planning Office requires a detailed structural method statement to be submitted at the planning application stage for subterranean development projects.
7. The potential long-term impact of a subterranean development abutting a shared party wall tends to be more significant in clayey soils than in gravelly or sandy soils (Sections 2.3 and 5.2). The associated engineering challenges can be addressed and mitigated in practice, and should not necessarily preclude a subterranean development under a non-detached property on clay soil, but it is appropriate for the Council consider whether explicit additional provision should be made in the planning requirements for subterranean developments adjacent to shared party walls on clay soils. At present under the UDP, the Planning Office requires a detailed structural method statement to be submitted at the planning application stage for subterranean development projects.
8. Under the LDF, the Proposals Map will provide a mechanism for implementing spatially-variant planning policies across the Borough. If it is decided by the Borough to implement a planning policy based on the near-surface soil type, it is important to recognise that, in practice, published geological maps are not necessarily definitive. On such maps, the boundary lines between zones of different soil types are often shown as dotted lines. Geologists have inferred these boundaries from available field data, and

they gradually amend the boundary lines as more field data becomes available to them. If geological data are to be included in the LDF Proposals Map, then it is recommended that this be carefully selected based on the latest available geological information.

9. **Next steps:** With reference to the Borough's original Briefing Document to Consultants, this Phase 1 scoping study has identified several issues as being potentially significant in relation to subterranean development in the Borough, and has also identified several issues as being less significant or insignificant. Within the wider context of the new Local Development Framework, it is now necessary to assess whether it is appropriate or necessary to include an explicit planning policy relating to subterranean development in the Borough, or whether the LDF covers the relevant issues implicitly.

FIGURES

LIST OF FIGURES

- Figure 2.1 a) Typical underpinning construction sequence
b) Underpinning construction sequence with 'hit and miss' pattern**
- Figure 2.2 Piles of small diameter (mini-piles) driven through existing foundations**
- Figure 2.3 'Cut and Cover' construction sequence typically used for garden basements**
- Figure 2.4 Major subterranean infrastructure (tunnels etc.)**
- Figure 2.5 Safeguarded zones of special archaeological potential**
- Figure 3.1 Geology: shallow soil strata that immediately underlie the ground surface**
- Figure 3.2 Geological map (1920)**
- Figure 3.3 Geological map (1995)**
- Figure 3.4 Geology: man-made ground and areas where soil has been infilled or worked**
- Figure 3.5 Shallow and surface water courses, including old rivers**
- Figure 4.1 Basement planning applications (2001-2007)**
- Figure 4.2 Basement planning applications: clustering**
- Figure 4.3 Basement planning applications and geological overlay (shallow soil strata)**
- Figure 6.1 Grade listed buildings in the Borough**
- Figure 6.2 Conservation areas in the Borough**
- Figure 6.3 Garden Squares in the Borough (as defined the Acts of 1851, 1863 & 1931)**

Stage 0: original foundation, typical of houses

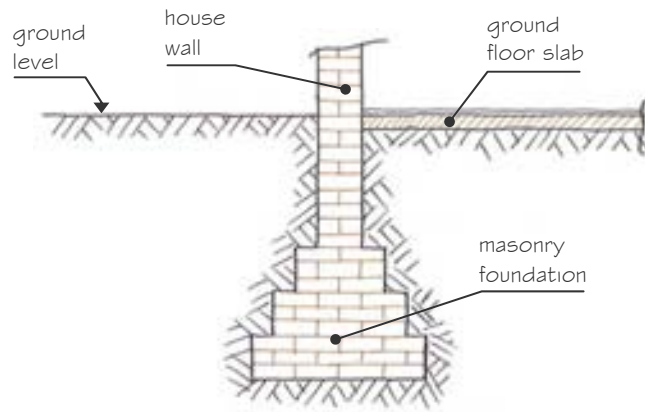

Stage 1: exposure of original foundation by digging a short trench along a section of the wall to be underpinned

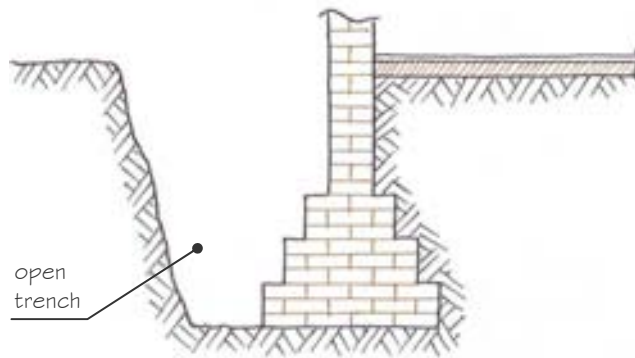

Stage 2: excavation of pit to form underpin: see Fig. 2.1b for details

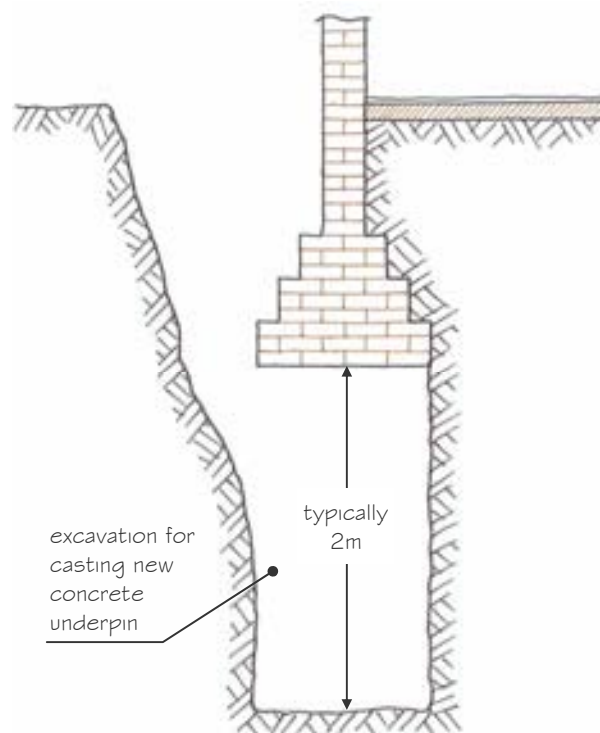

Indicative, schematic sketches only.
Actual dimensions are likely to vary.
Not to scale.

RBKC SUBTERRANEAN DEVELOPMENT Typical underpinning construction sequence

Stage 2a: excavation and concreting of initial section

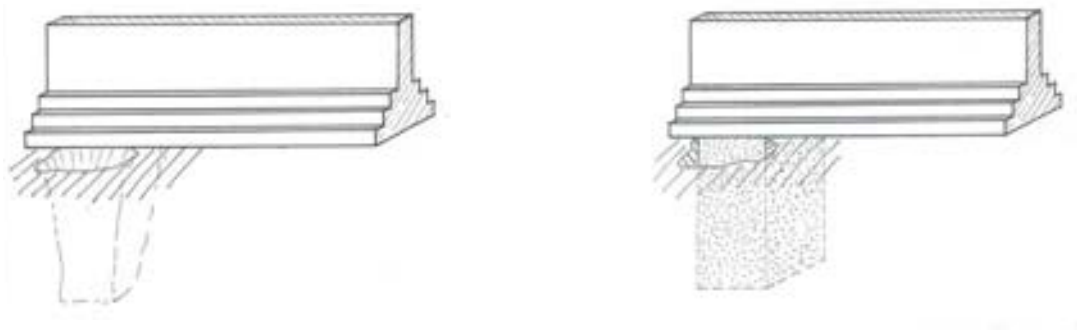

Stage 2b: excavation and concreting of another section, not adjacent to first one

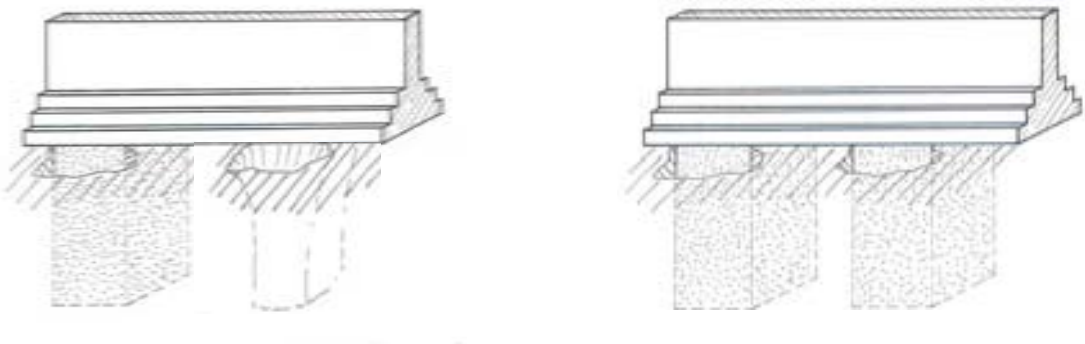

Stage 2c: excavation and concreting of an intermediate section, to form contiguous rows of underpin

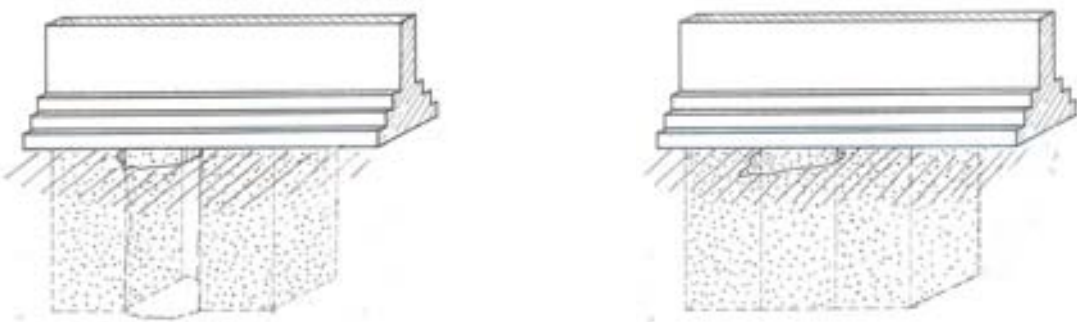

Indicative, schematic sketches only.
Actual dimensions are likely to vary.
Not to scale.

RBKC SUBTERRANEAN DEVELOPMENT
Underpinning construction sequence with
'hit and miss' pattern

123002

FIGURE **2.1b**

Stage 1: piling on one side

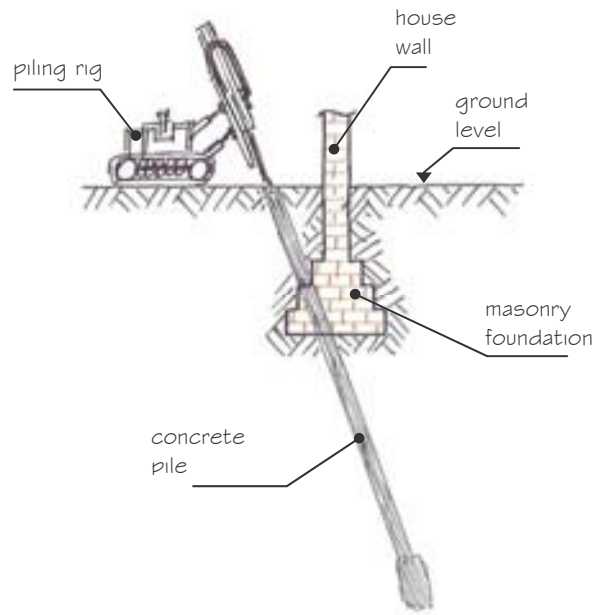

Stage 2: piling on the other side

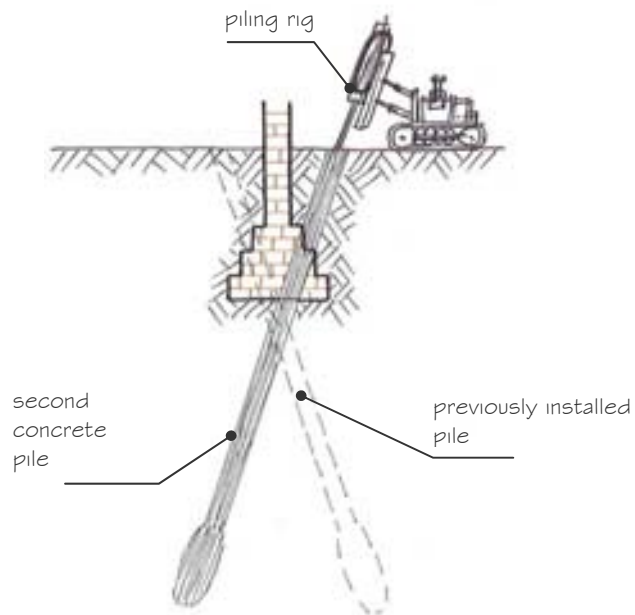

Indicative, schematic sketches only.
Actual dimensions are likely to vary.
Not to scale.

**RBKC SUBTERRANEAN DEVELOPMENT
Piles of small diameter (mini-piles) driven
through existing foundations**

123002

FIGURE **2.2**

Stage 1: installation of piled walls

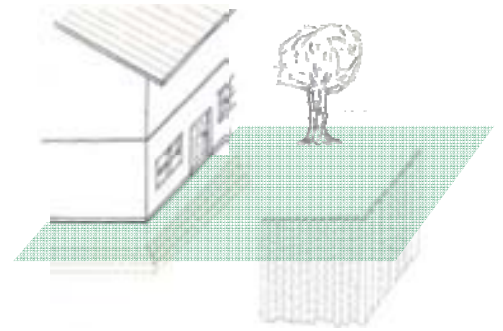
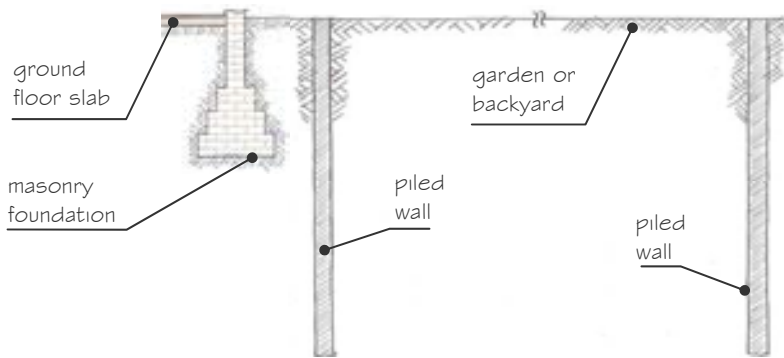

Stage 2: excavation and construction of basement slab

Note: temporary propping support is essential, but is not shown in sketches for clarity

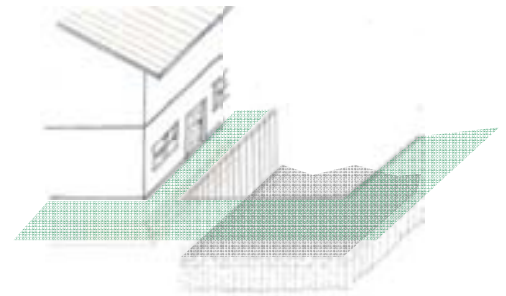
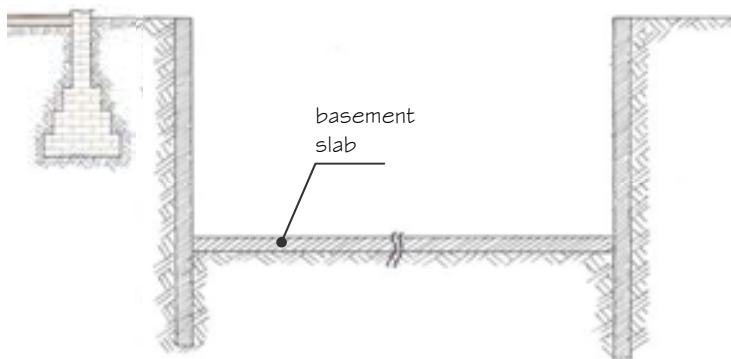

Stage 3: construction of basement walls and cover, before reinstating garden

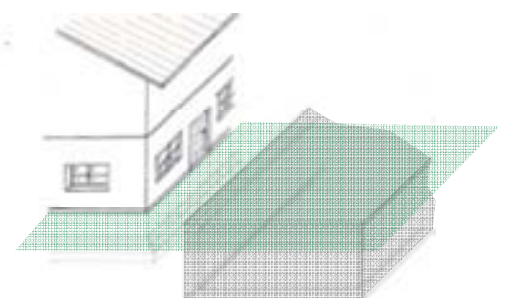
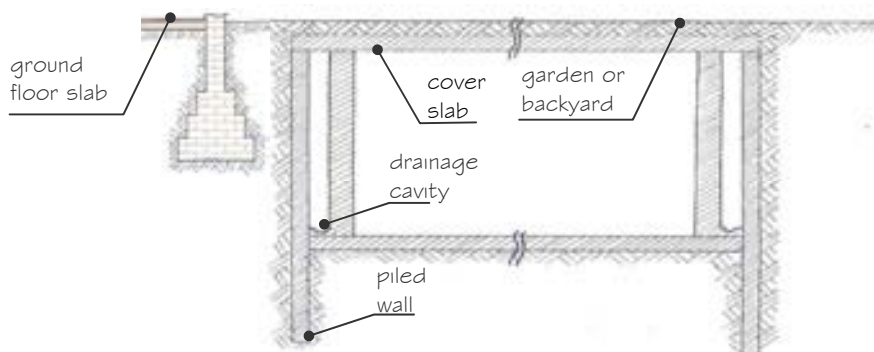

Indicative, schematic sketches only.
Actual dimensions are likely to vary.
Not to scale.

**RBKC SUBTERRANEAN DEVELOPMENT
“Cut and cover” construction sequence
typically used for garden basements**



Map produced by the Royal Borough of Kensington and Chelsea
Planning Services Department using GGP 27/10/2006

NOT TO SCALE
ORIGINAL SCALE 1:25.000

RBKC SUBTERRANEAN DEVELOPMENT
Major subterranean infrastructure
(including existing and proposed tunnels)

123002

FIGURE **2.4**

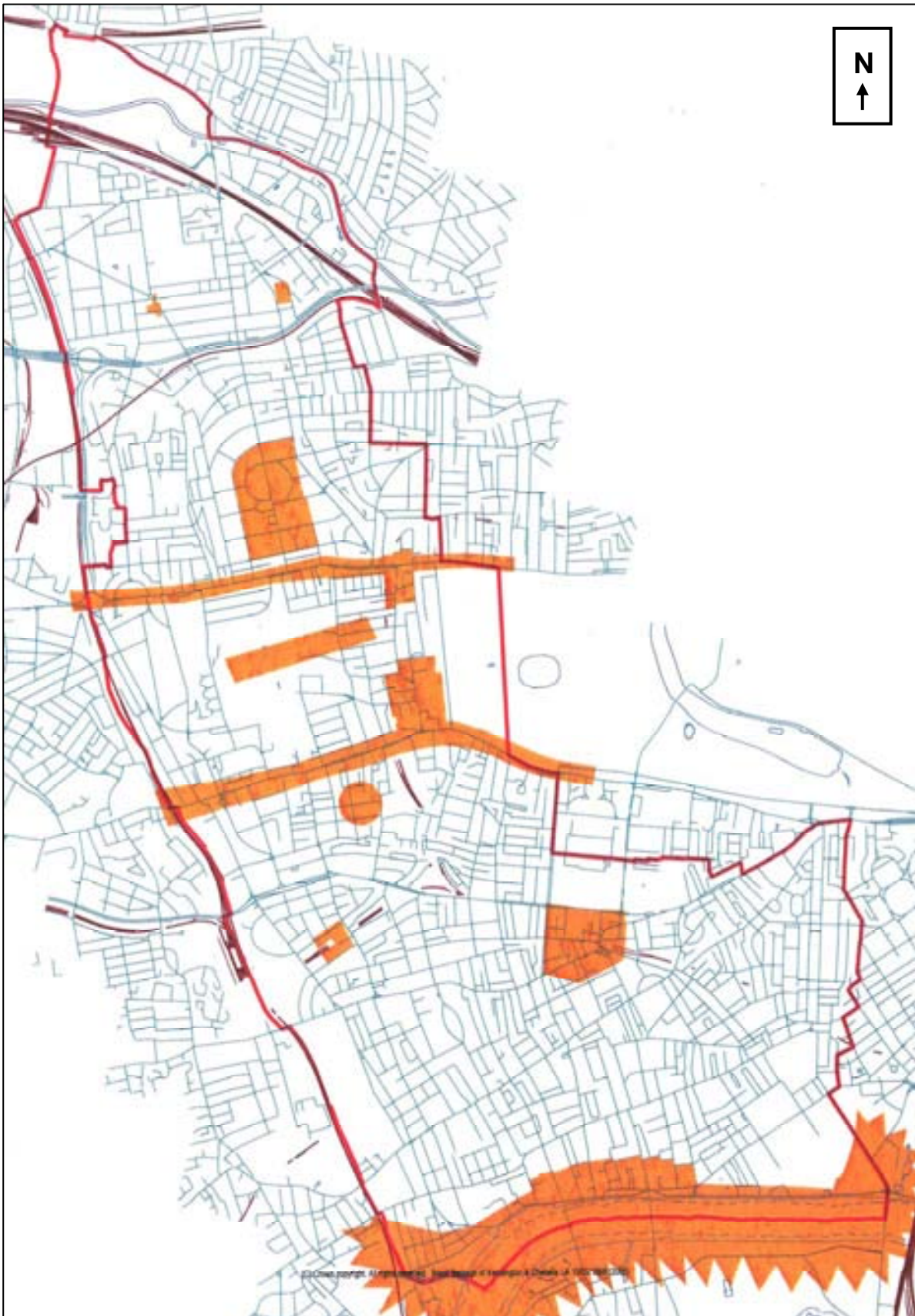

Map produced by the Royal Borough of Kensington and Chelsea
Planning Services Department using GGP 12/12/2006

NOT TO SCALE
ORIGINAL SCALE 1:25.000

RBKC SUBTERRANEAN DEVELOPMENT
Safeguarded zones of special archaeological potential

123002

FIGURE **2.5**



Map produced by the Royal Borough of Kensington and Chelsea
 Planning Services Department using GGP 13/11/2006

NOT TO SCALE
 ORIGINAL SCALE 1:25,000

RBKC SUBTERRANEAN DEVELOPMENT
Geology: shallow soil strata that
immediately underlie the ground surface

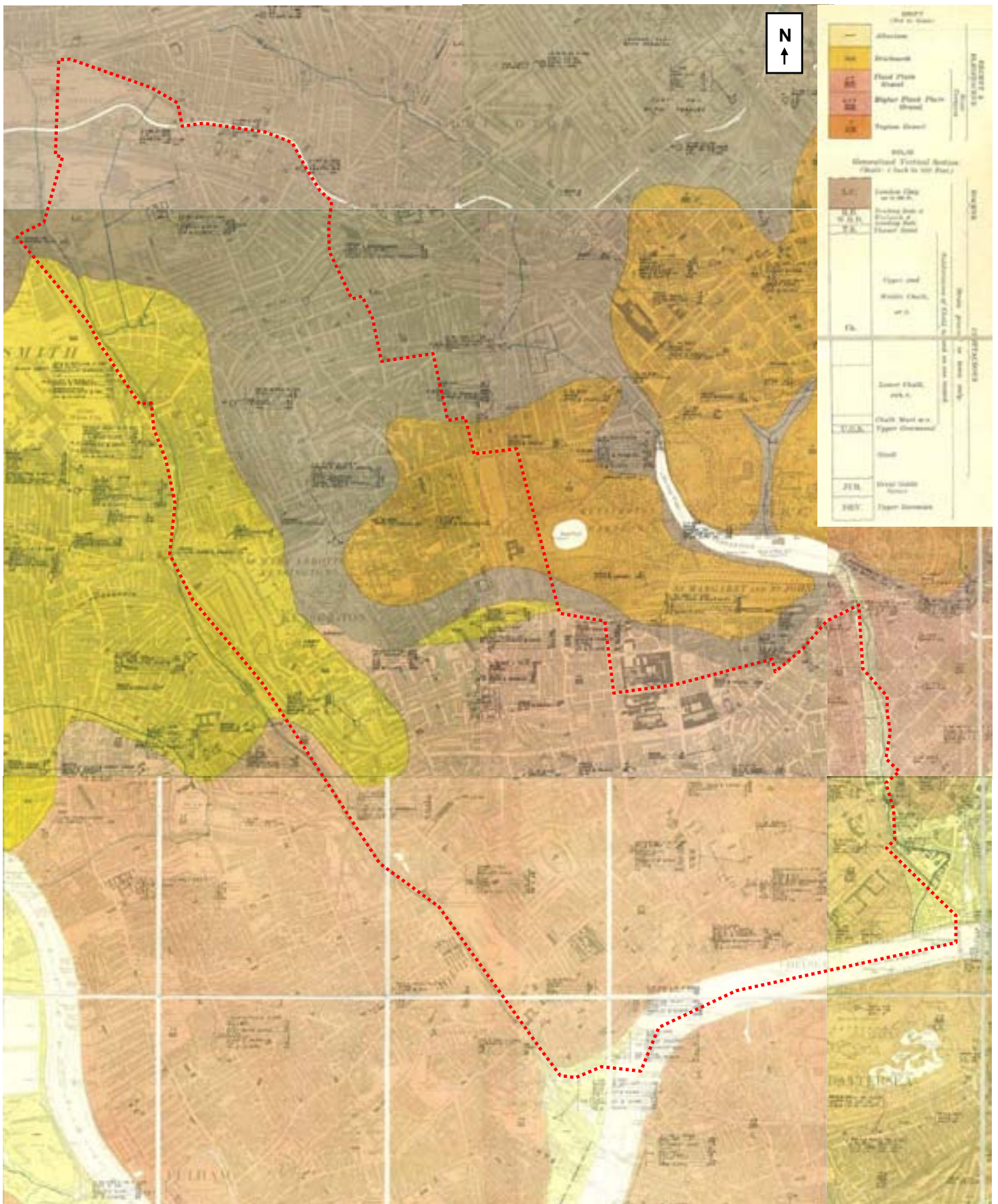

Geological Survey of England and Wales
 Sheets: IV NE, IV SE, V SW, V NW, VIII NE, IX NW.

NOT TO SCALE
 ORIGINAL SCALE 1:10560

RBKC SUBTERRANEAN DEVELOPMENT Geological map (1920)

123002

FIGURE **3.2**

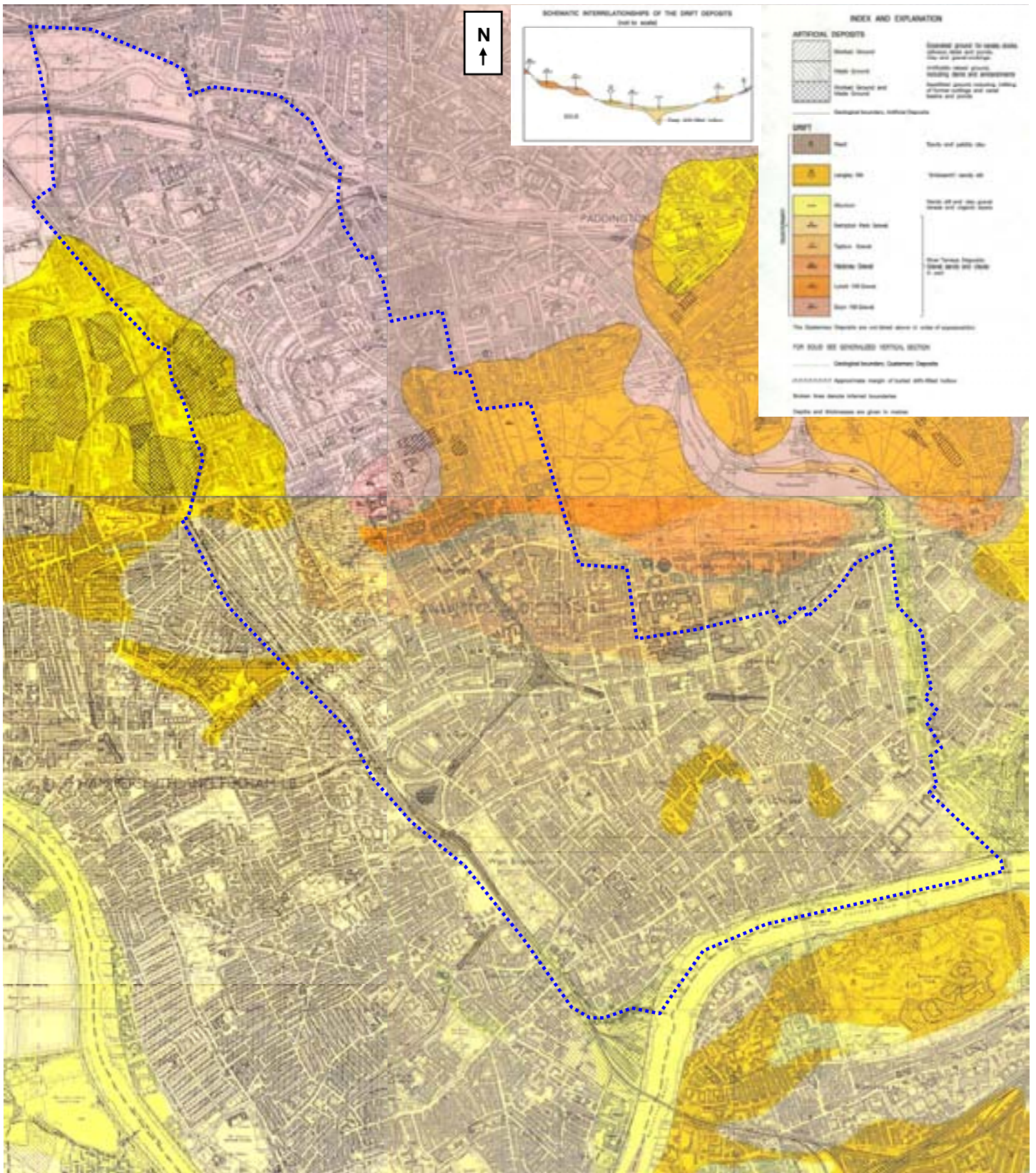

British Geological Survey
Sheets: IV TQ28SW, TQ28SE, TQ27NW, TQ27NE.

NOT TO SCALE
ORIGINAL SCALE 1:10000

RBKC SUBTERRANEAN DEVELOPMENT Geological map (1995)

123002

FIGURE **3.3**

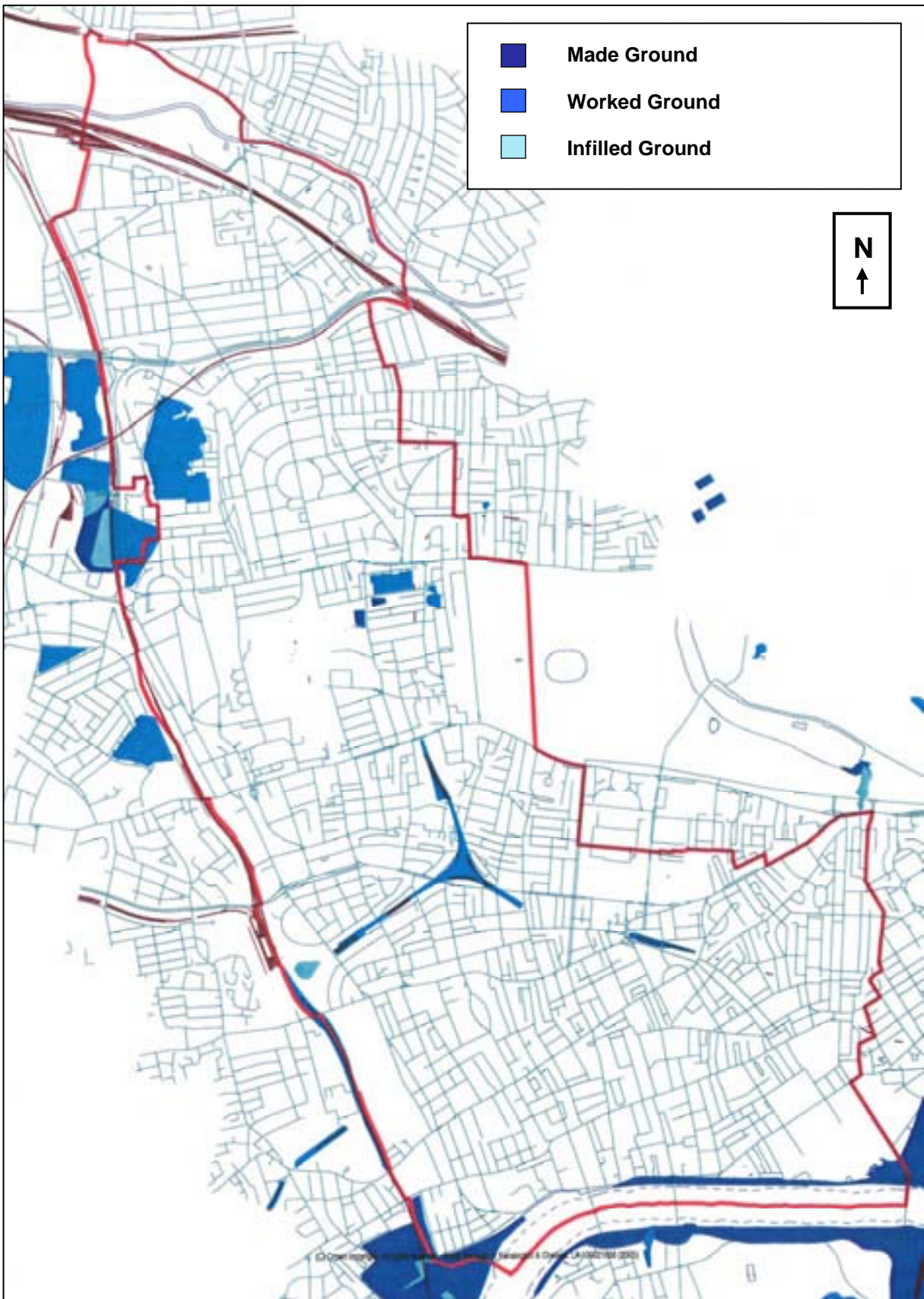

Map produced by the Royal Borough of Kensington and Chelsea
 Planning Services Department using GGP 13/11/2006

NOT TO SCALE
 ORIGINAL SCALE 1:25,000

RBKC SUBTERRANEAN DEVELOPMENT
Geology: man-made ground and areas
where soil has been infilled or worked

123002

FIGURE **3.4**

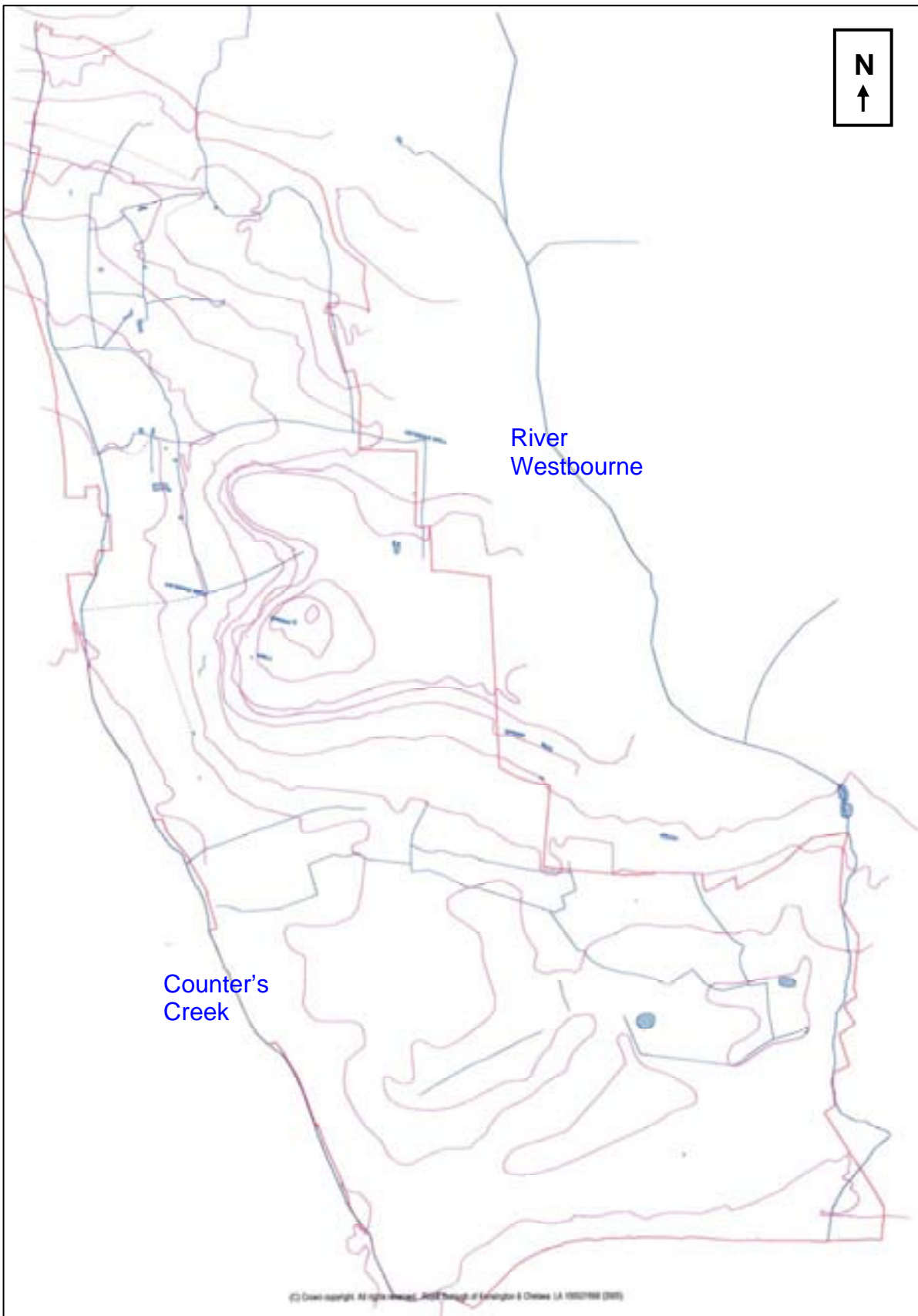

Map produced by the Royal Borough of Kensington and Chelsea
 Planning Services Department using GGP 30/11/2006

NOT TO SCALE
 ORIGINAL SCALE 1:25,000

RBKC SUBTERRANEAN DEVELOPMENT
Shallow and surface water courses, including old rivers

123002

FIGURE **3.5**

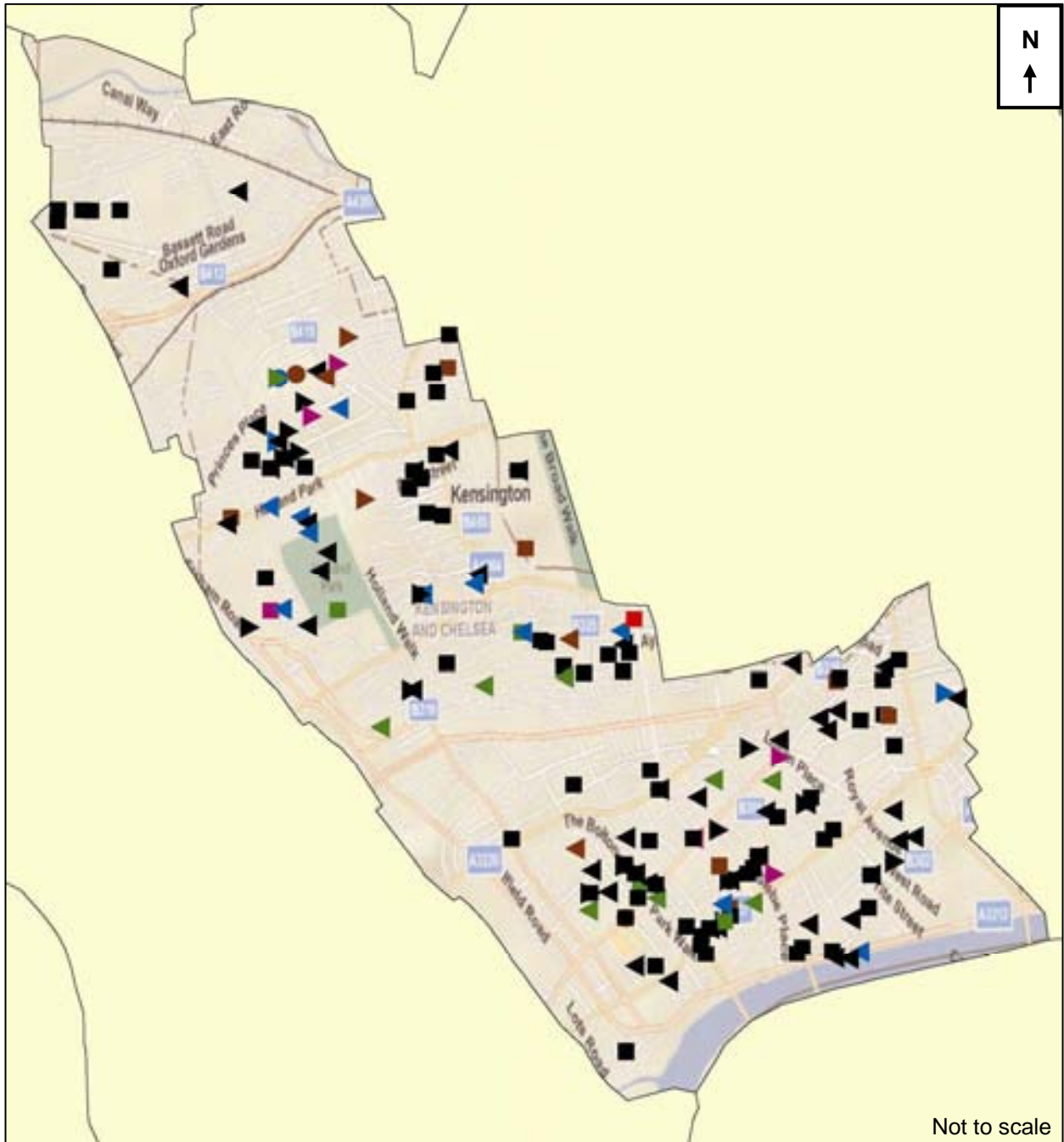

Spatial distribution of Planning Applications for residential basements received by RBKC Planning Office in the period 2001 to June 2007. Mapped positions derived from post codes (excluding house numbers).

Purpose of basement

- Swimming pool ●
- Car parking ●
- Living space ●
- Recreation/gym ●
- Utilities/storage ●
- Not stated ●

Basement located under

- Building (house)
- Rear garden
- Front garden
- Garage/driveway

**RBKC SUBTERRANEAN DEVELOPMENT
Basement planning applications (2001-2007)**

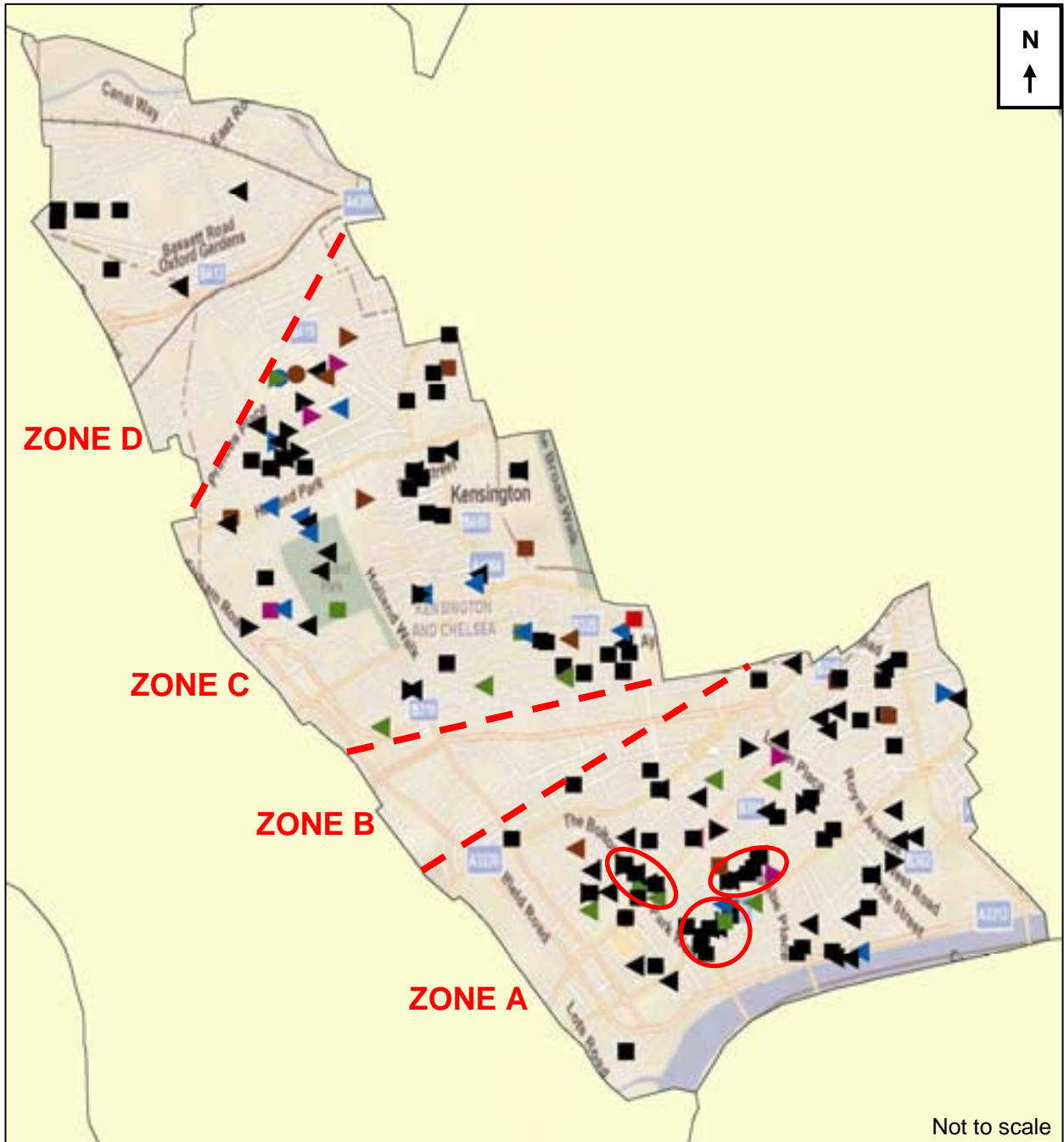

Spatial distribution of Planning Applications for residential basements received by RBKC Planning Office in the period 2001 to June 2007. Mapped positions derived from post codes (excluding house numbers). Zones shown are indicative, and are for discussion purposes only.

RBKC SUBTERRANEAN DEVELOPMENT
Basement planning applications: clustering

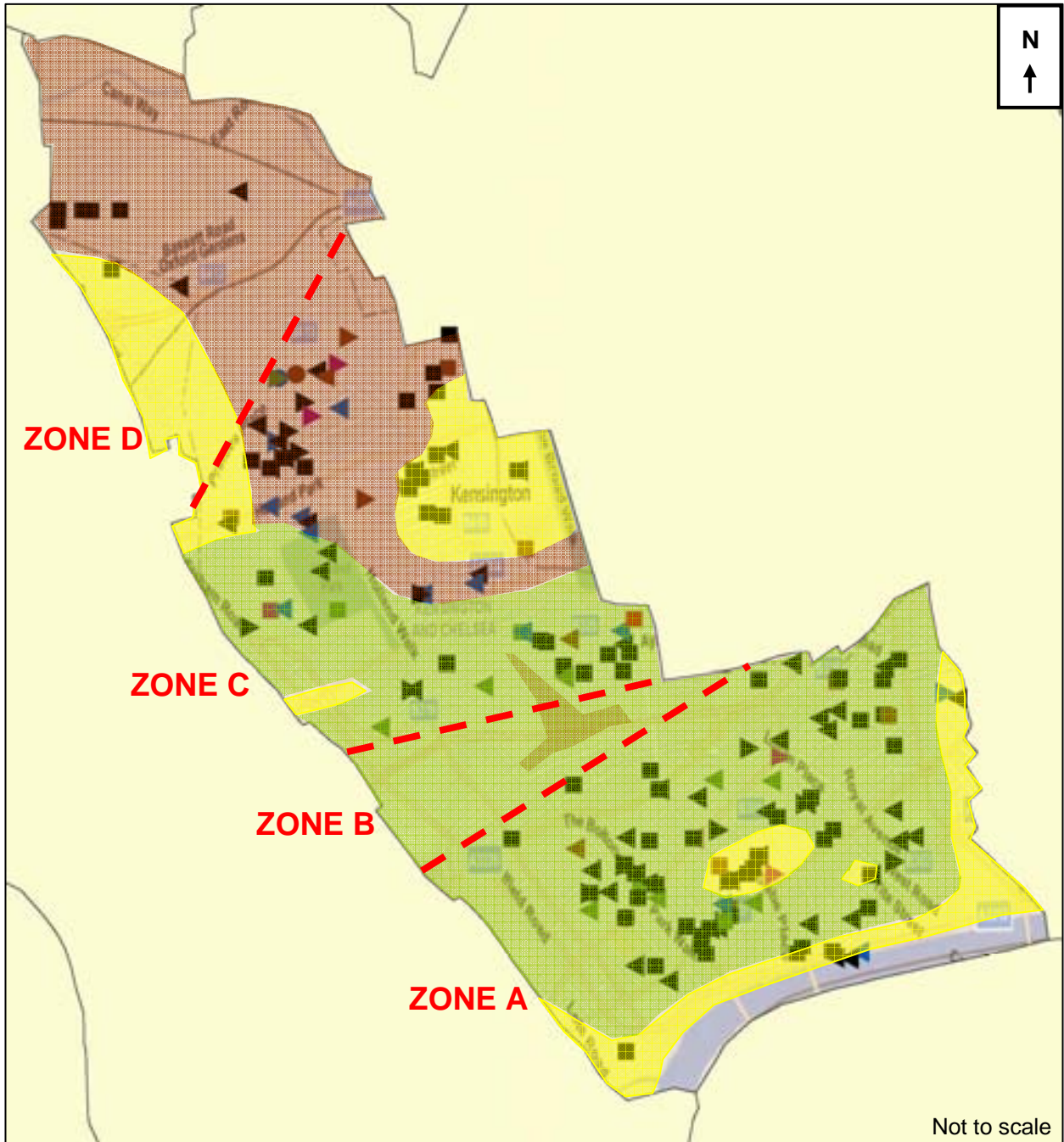

Spatial distribution of Planning Applications for residential basements received by RBKC Planning Office in the period 2001 to June 2007. Mapped positions derived from post codes (excluding house numbers).

- Soil type
- Silts
 - Gravels
 - Clays

RBKC SUBTERRANEAN DEVELOPMENT
Basement planning applications and
geological overlay (shallow soil strata)

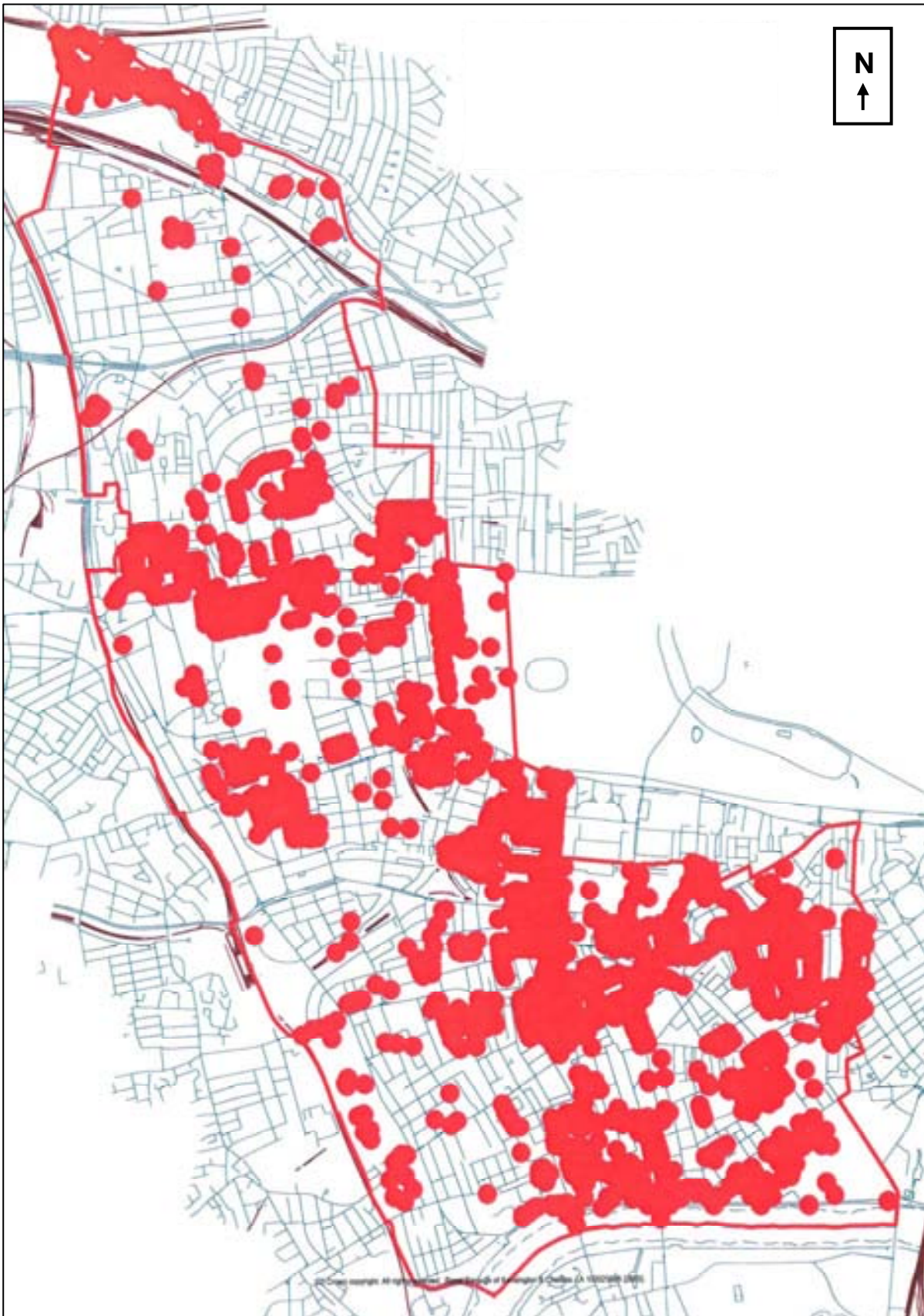

Map produced by the Royal Borough of Kensington and Chelsea
Planning Services Department using GGP 01/11/2006

NOT TO SCALE
ORIGINAL SCALE 1:25.000

RBKC SUBTERRANEAN DEVELOPMENT Grade listed buildings in the Borough

123002

FIGURE **6.1**

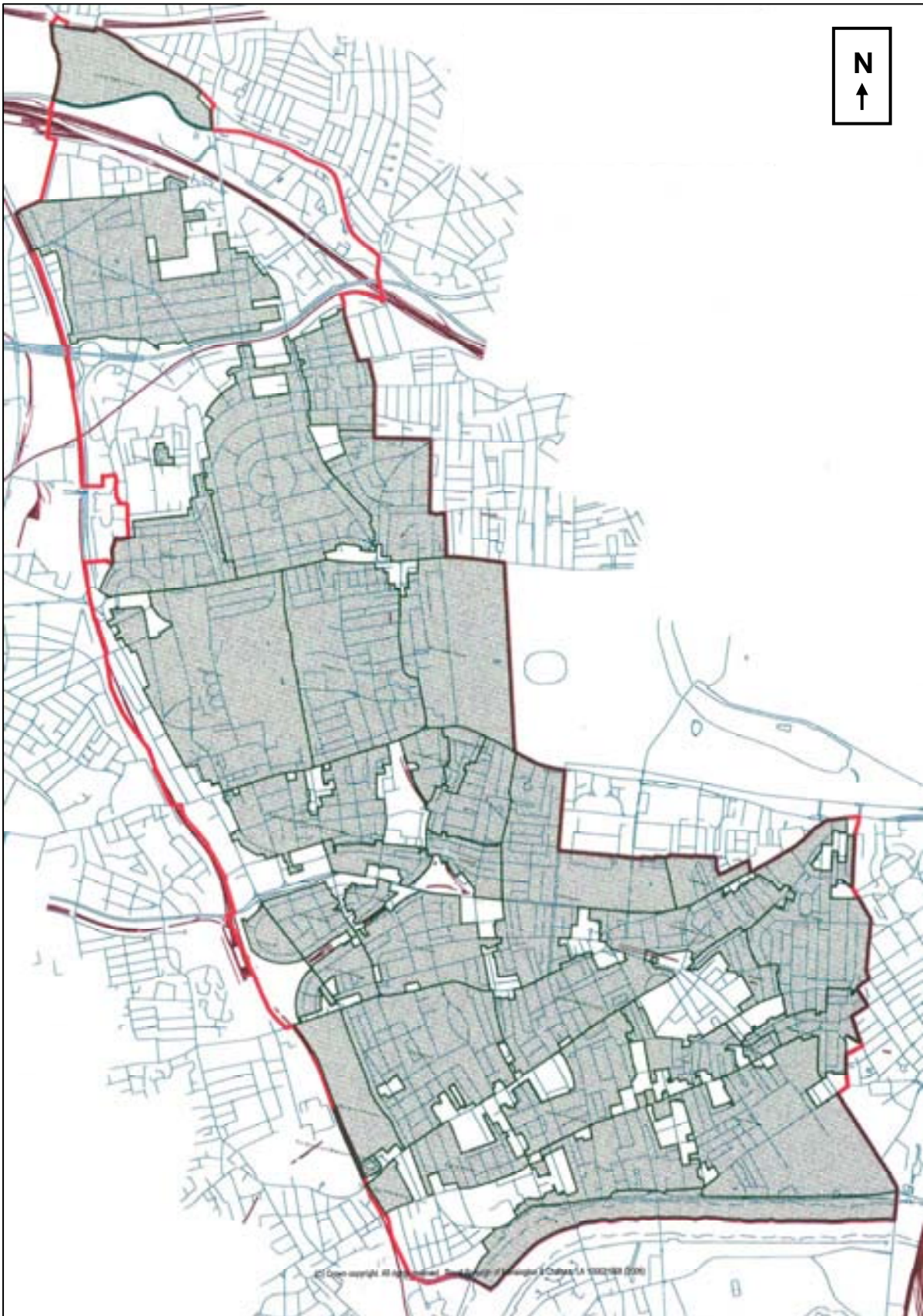

Map produced by the Royal Borough of Kensington and Chelsea
Planning Services Department using GGP 01/11/2006

NOT TO SCALE
ORIGINAL SCALE 1:25.000

RBKC SUBTERRANEAN DEVELOPMENT Conservation Areas in the Borough

123002

FIGURE **6.2**



Map produced by the Royal Borough of Kensington and Chelsea
Planning Services Department using GGP 07/11/2006

NOT TO SCALE
ORIGINAL SCALE 1:25.000

RBKC SUBTERRANEAN DEVELOPMENT
Garden Squares in the Borough
(as defined the Acts of 1851, 1863 & 1931)

123002

FIGURE **6.3**

Arup**Geotechnics**

Appendix A

**Effects of excavation
on foundation
strengths**

A1 Effect of excavations on the load bearing capacity of shallow foundations, including influence of geology

A1.1 Executive summary

This appendix discusses the influence of excavations on the load bearing capacity of shallow foundations (pad footings and strip footings, but not deep piles) of the type that typically support residential properties in the Borough. Attention is drawn to the three ways that shallow foundations gain their load bearing capacity from the soil around them, namely:

- the frictional strength of the soil;
- the “cohesive” strength of the soil;
- the self-weight of the soil that overlies the footing (called the “overburden”).

When the soil around a footing is excavated, the beneficial effects of the “overburden” will be reduced or even wholly removed, depending on the depth of the excavation. The load bearing capacity of a footing is therefore reduced by a nearby excavation. When assessing the implications of a reduction in overburden due to excavation close to a footing, three possible scenarios can be considered:

- If the load bearing capacity of the exposed footing becomes **significantly** less than the load that the footing is trying to support, then the footing could potentially fail and this could lead to the collapse of the structure that the footing supported.
- If the load bearing capacity of the exposed footing becomes **moderately** less than the load that the footing is trying to support, then the footing may settle more than is desirable (but without fully failing), and this may cause cracking of the structure that the footing supports.
- If the load bearing capacity of the exposed footing becomes only **slightly** less than the load that the footing is trying to support, then no settlement or cracking is likely to occur.

The magnitudes of the adverse effects of an excavation near a footing differ significantly for foundation in clayey soils and foundations in gravelly soils. Specifically, the overall impact of a loss of overburden is typically much greater in gravelly soils than in clayey soils. Within the Borough, the northern districts are generally on clayey soils (London Clay) whereas the southern districts are generally on gravelly soils (River Terrace Gravels).

In the following sections, simple engineering calculations illustrate in more detail the potential effects of loss of overburden, and how the magnitudes of these effects can differ in clay soils and gravel soils. The calculations make use of assumed generic values for soil properties, and they are intended for illustrative purposes only, not guidance.

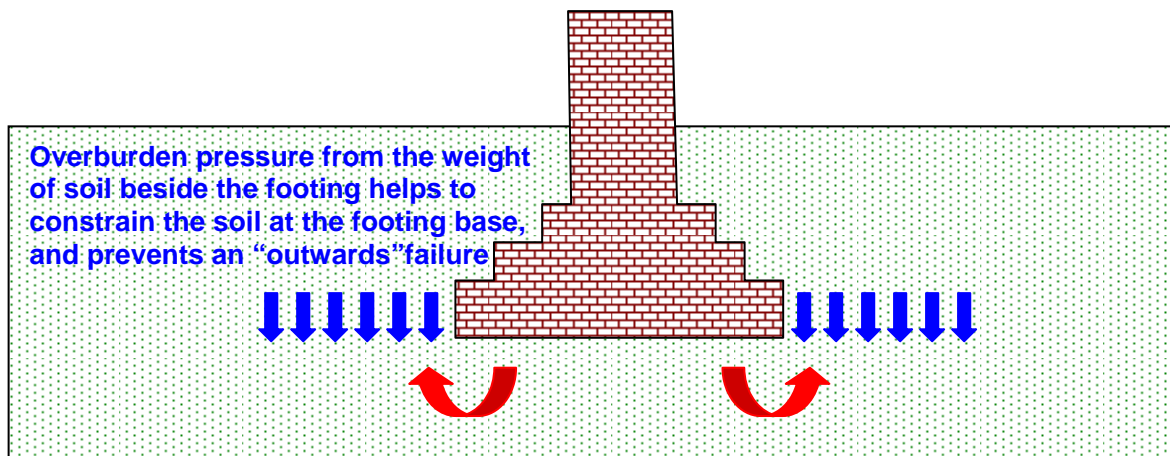

A1.2 Some soil theory

The mechanical behaviour of soil is often modelled using the Mohr-Coulomb strength criterion, which describes the overall strength of soil in terms of a “cohesive” component (denoted c) and a frictional component (denoted ϕ).

In general, a clay soil under load will show a relatively high cohesive component but a negligible frictional strength component. In contrast, a gravel soil under load will typically show a relatively high frictional component, but negligible cohesive component.

Some typical generic values for gravel and clay are listed in Table A1. These values will be used for the illustrative calculations presented below.

Table A1: Assumed typical soil properties for gravel and clay (illustrative only)

Soil type	Frictional strength component: Effective angle of shearing resistance of soil (ϕ) [°]	“Cohesive” strength component: Shear strength of soil (c) [kPa]
Gravel	30	Nil
Clay	nil	60

A1.3 Calculating the load bearing capacity of a footing

The design of a foundation requires an evaluation of the ultimate bearing capacity of the soil; that is, the ability of the soil to bear the weight of the building without failing.

Broadly, the load bearing capacity of a shallow footing (a pad or a strip footing) is made up of three components:

Load bearing capacity of footing	=	frictional component from soil strength	+	“cohesive” component from soil strength	+	overburden contribution from self-weight of soil, to depth of footing
----------------------------------	---	---	---	---	---	---

More formally in engineering terms, the bearing capacity of a footing can be calculated using well-established formulae published in the technical literature. A common approach, which is widely used to calculate the ultimate (that is, “just-at-failure”) load capacity of a shallow footing, was given by Brinch Hansen (1970)⁴. The Brinch Hansen formula takes account of the geometry of the foundation (for example, square pads differ from long thin strips), the properties of the soil in which the footing sits, and the effects of the overburden that acts above the foundation level.

$$q_{ult} = [0.5 \gamma B.N_{\gamma}] + [c.N_c] + [\gamma D.N_q]$$

where:

q_{ult}	is the ultimate bearing capacity
$0.5\gamma B.N_{\gamma}$	is the frictional contribution
$c.N_c$	is the cohesion contribution
$\gamma D.N_q$	is the overburden contribution

and the symbols mean:

γ	self-weight of the soil, per unit volume
B	width of the foundation
D	depth of the base of the footing, below ground level

⁴ Brinch Hansen, J. (1970) *A revised and extended formula for bearing capacity*. Danish Geotechnical Institute Bulletin No.28, 5-11

c	soil cohesion
N_γ, N_c, N_q	bearing capacity factors for friction, cohesion, overburden (Vesic, 1975)

The friction angle (ϕ) does not appear explicitly in the Brinch Hansen formula, but in practice it strongly influences the Vesic “N” coefficients. Using the generic soil properties given in Table A1, Table A2 shows the “N” coefficients derived using the Vesic (1975)⁵ approach.

Table A2: Examples of Vesic “N” factors for gravel and clay soils (illustrative only)

Soil type	Friction factor N_γ	Cohesion factor N_c	Overburden factor N_q
Gravel	22	30	18
Clay	Nil	5	1

Special attention is drawn to the high N_q value for gravel compared with the low value for clay (Table A2). It is mainly through this difference in the N_q factors for gravel and clay that the impact of losing overburden tends to be proportionally greater in gravel than in clay.

The ultimate bearing capacity (q_{ult}) is the calculated stress at which a footing is expected to be just-at-failure. Obviously, having a foundation that is close to failure should be avoided in practice. Therefore, in modern design, the allowable design bearing capacity of the footing (q_d) is typically taken as, for example, one third of the calculated ultimate bearing capacity (q_{ult}). Thus, there is a “factor of safety” of 3 in the design of the footing. Inherent within this empirical factor of safety is an allowance that keeps settlements within tolerable limits.

$$q_d = q_{ult} / 3$$

where:

- q_d is the design load bearing capacity of the footing (the maximum working stress)
- q_{ult} is the ultimate bearing capacity of the footing (from the previous equation)
- 3 is the factor of safety on the design of the footing.

It should be noted that this describes how shallow footings would typically be designed by engineers nowadays. Much of the older building stock in the Borough is likely to be founded on shallow footings that were not “designed” in the modern engineering sense. The footings would have been constructed by masons and builders based on rules-of-thumb and experience, and in response to local variations in the ground that these artisans encountered when they started digging at any given location. Nevertheless, the bearing capacities and factors of safety of old foundations can be back-analysed and estimated using formulae such as those outlined above.

A1.4 Effects of excavation: a calculated example

When an underpin is being installed for a basement development, a trench is excavated down to the founding level on one side of the existing footing (see Figure 2.1). Although the trench excavation is only dug on one side of the footing, the beneficial contribution of the total overburden on both sides of the wall can no longer be taken into account, because an asymmetric failure of the footing could potentially occur towards the excavated side.

The following illustrative example looks at the case of a foundation that extends 1.5m below ground level. It considers the effects of digging a 1.5m deep trench along one side of this footing, extending right down to the base of the footing.

For both clay and gravel soils, the typical self-weight of soil per unit volume is assumed to be 20 kN/m³ (this means a density of 2,000 kg per cubic metre of soil). The loss of

⁵ Vesic, A.S. (1975) *Bearing capacity of shallow foundations* Foundation Engineering Handbook, ed. Winterkorn & Fang, publ. Van Nostrand Reinhold Co., New York, pp.121-147

overburden by digging out 1.5m of soil is therefore 30 kPa ($=1.5 \times 20$ kilopascals). However, according to the design formulae given above, this stress value must be factored by significantly different N_q factors for gravel and for clay (Table A2).

Table A3 shows the results of applying Brinch Hansen's formula for calculating bearing capacity, both before and after digging a 1.5m trench alongside the illustrative 1.5m deep footing. Estimates are given for footings founded in gravel and clay soils, respectively.

Table A3: Theoretical change in ultimate load bearing capacity, before and after digging a 1.5m deep trench next to the illustrative footing (see text for details)

Soil type	Before or after the 1.5m excavation?	Frictional component [$0.5 \gamma B N_q$] (kPa)	"Cohesive" component [$c N_c$] (kPa)	Overburden component [$\gamma D N_q$] (kPa)	Ultimate bearing capacity q_{ult} [kPa]
Gravel	Before digging	224	0	552	776
Gravel	After digging	224	0	nil	224
Clay	Before digging	0	308	30	338
Clay	After digging	0	308	nil	308

A1.5 Conclusions

For foundations on **clay** soil, Table A3 shows that the bearing capacity of a footing should not be substantially affected by loss of overburden associated with excavation near the footing. In the example used, the post-dig value of 308 kPa compares closely to the pre-dig value of 338 kPa: there is only a 10% post-dig reduction in the ultimate bearing capacity of the footing analysed here. Unless the building load being supported by a clay-founded footing happens already to be close to the ultimate bearing capacity of that footing (which is unlikely, although it should be checked for), then a 10% loss in foundation capacity is likely to have little adverse effect on the structure being supported.

In contrast for the **gravel** soil, Table A3 shows a major reduction in the bearing capacity of the footing due to the loss of overburden (down to 224kPa, from an initial value of 776kPa). For the gravel soil, there is a 70% decrease in the bearing capacity for the footing analysed here. For an historic building, it is unlikely that the existing "factor of safety" on the foundation design would be as high as the safety factors that are used nowadays (such as the modern value of 3 that was discussed above). Analyses by Arup of shallow foundations in London of historical structures founded on the River Terrace Gravels show typical ratios of the calculated ultimate bearing capacity to the applied load in the range 1.6 to 2.5. A 70% decrease in the load bearing capacity of a footing that already has a factor of safety of only 1.6 is likely to be significant and adverse. However, a 70% decrease in the load bearing capacity of a footing that has an existing factor of safety of 2.5 is likely to be much less significant, because the modified factor of safety should still be satisfactorily high, albeit reduced. For foundations on gravel soils, a detailed analysis of the existing load bearing capacity and existing factor of safety of the foundations is therefore especially important. Any adverse reduction in the factor of safety must be carefully mitigated by the design, the construction method (including temporary works), and the workmanship adopted on site.

It is important to emphasise that the numbers quoted in this appendix are examples, and have been presented here for illustrative purposes only. They do not relate directly to any specific foundation or structure. Other factors also affect foundation stability, including the length of time that an excavation is left open. This factor particularly affects clay soils.