



Notes

Existing centre lines removed

New pedestrian islands built to RBKC's streetscape standard

Proposed raised table across Oakley Street j/w Phene Street

Existing centre lines removed

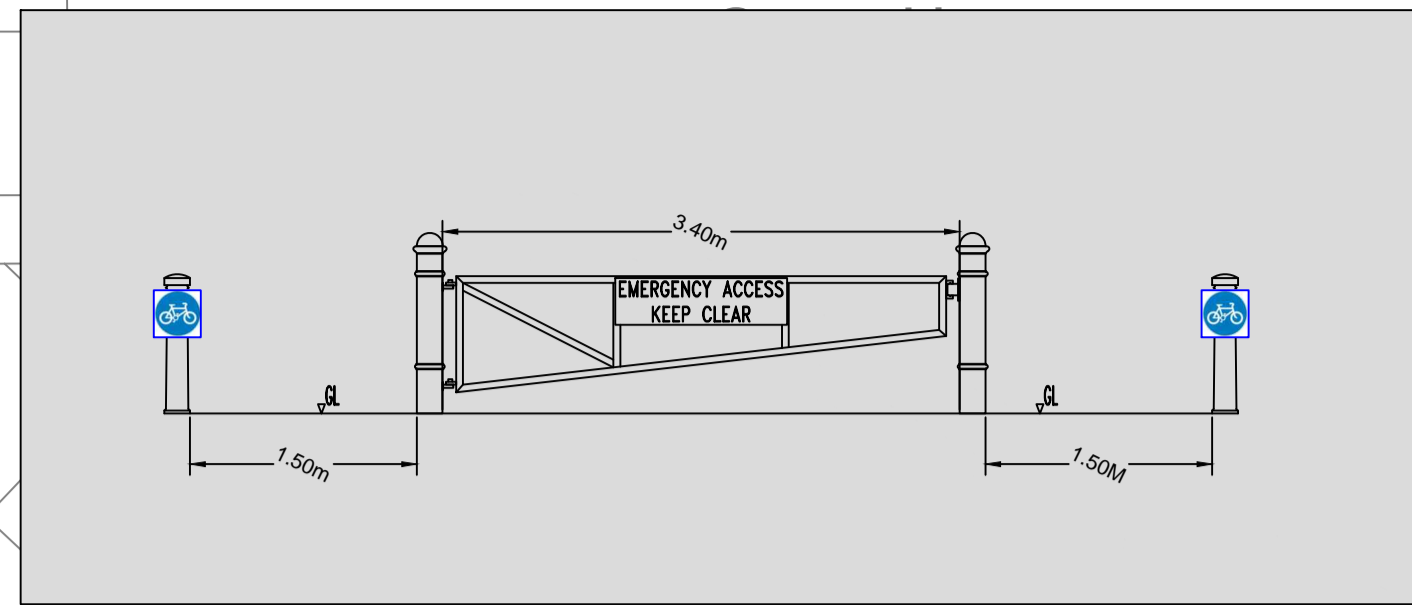
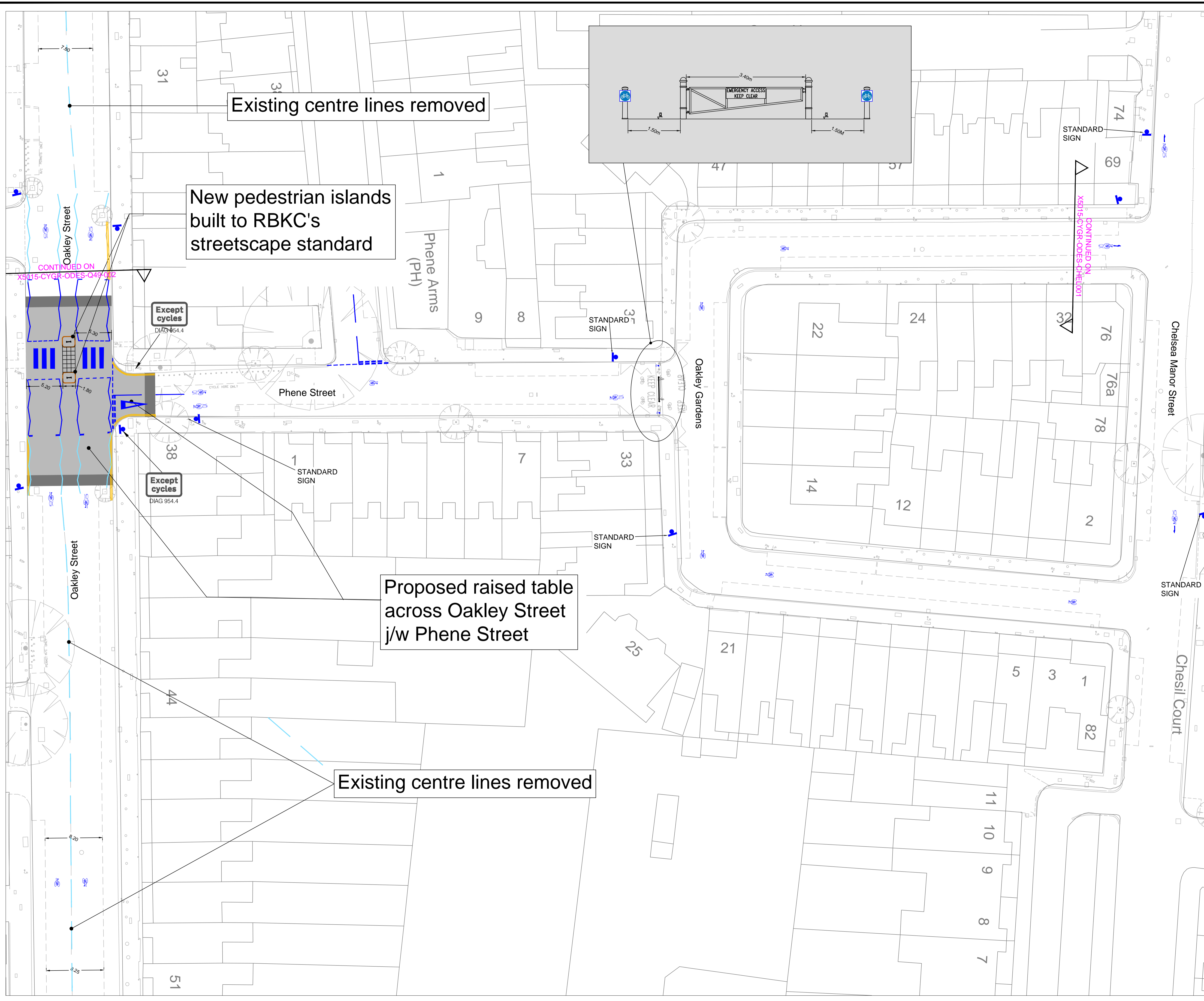

Except cycles
DIAG 954.4

Except cycles
DIAG 954.4

1 STANDARD SIGN

3 STANDARD SIGN

1 STANDARD SIGN

STANDARD SIGN

STANDARD SIGN

Rev	Description	By	Date	Chk

DEPARTMENT OF TRANSPORTATION AND HIGHWAYS
Traffic & Transportation Policy Service

The Royal Borough of Kensington and Chelsea
Town Hall, Hornton Street, London, W8 7NX
Telephone: (020) 7361 3374
Fax: (020) 7361 2796

Project
CENTRAL LONDON CYCLING GRID

Title
RBKC QUIETWAY ROUTE PROPOSALS
CHELSEA QUIETWAY 1 OF 7
(PHENE STREET)

Scale 1:250	Drawn EE	Checked Date	A1
Drawing Number X5015-CYGR-ODES-CHEL001	Date 19.02.15	Rev 0	

Cad File: \DRAWINGS\...



Notes

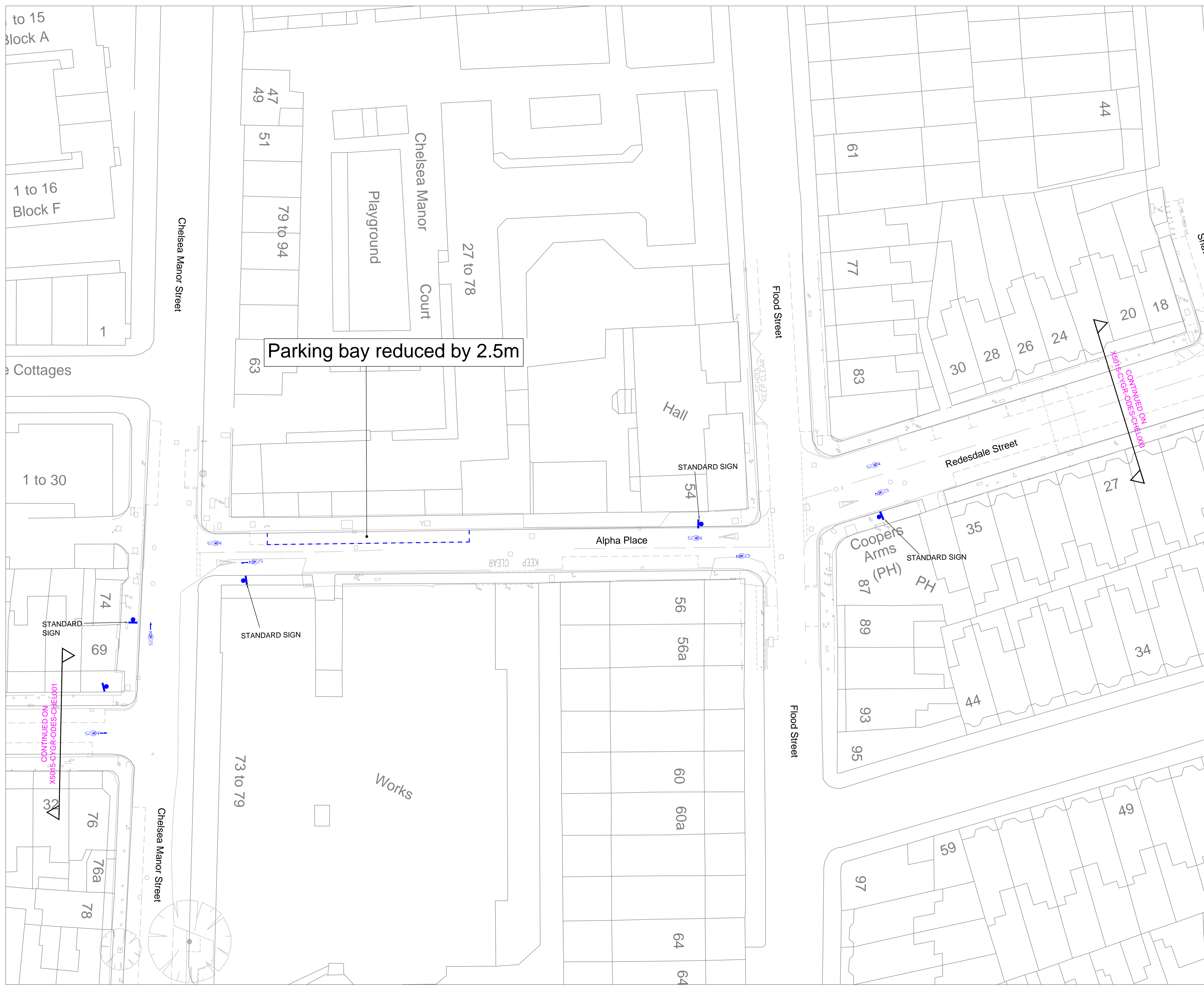

Parking bay reduced by 2.5m

CONTINUED ON SHEET CYGR-ODES-CHEL008

CONTINUED ON SHEET CYGR-ODES-CHEL001

Rev	Description	By	Date	Chk

DEPARTMENT OF TRANSPORTATION AND HIGHWAYS
Traffic & Transportation Policy Service

The Royal Borough of Kensington and Chelsea
Town Hall, Hornton Street, London, W8 7NX
Telephone: (020) 7361 3374
Fax: (020) 7361 2796

Project
CENTRAL LONDON CYCLING GRID

Title
RBKC QUIETWAY ROUTE PROPOSALS
CHELSEA QUIETWAY 2 OF 7
(ALPHA PLACE)

Scale 1:250	Drawn EE	Checked 	A1
Date 19.02.15	Date 	Date 	
Drawing Number X5015-CYGR-ODES-CHEL002	Rev 0		

Cad File: DRAWINGS...

DO NOT SCALE

© Crown copyright and database rights 2012.
Ordnance Survey 100021668



Notes



Rev	Description	By	Date	Chk



DEPARTMENT OF TRANSPORTATION AND HIGHWAYS
Traffic & Transportation Policy Service

The Royal Borough of Kensington and Chelsea
Town Hall, Hornton Street, London, W8 7NX
Telephone: (020) 7361 3374
Fax: (020) 7361 2796

Project
CENTRAL LONDON CYCLING GRID

Title
**RBKC QUIETWAY ROUTE PROPOSALS
CHELSEA QUIETWAY 3 OF 7
(REDESDALE STREET)**

Scale 1:250	Drawn EE	Checked Date	A1
Drawing Number X5015-CYGR-ODES-CHEL003	Date 19.02.15	Date	
Rev			0

Cad File: \DRAWINGS\...

DO NOT SCALE

© Crown copyright and database rights 2012.
Ordnance Survey 100021668



Notes



Rev	Description	By	Date	Chk



DEPARTMENT OF TRANSPORTATION AND HIGHWAYS
Traffic & Transportation Policy Service

The Royal Borough of Kensington and Chelsea
Town Hall, Hornton Street, London, W8 7NX
Telephone: (020) 7361 3374
Fax: (020) 7361 2796

Project
CENTRAL LONDON CYCLING GRID

Title
**RBKC QUIETWAY ROUTE PROPOSALS
CHELSEA QUIETWAY 4 OF 7
(TEDWORTH SQUARE)**

Scale 1:250	Drawn EE	Checked Date	A1
19.02.15	Date	Date	
Drawing Number X5015-CYGR-ODES-CHEL004			Rev 0

Cad File: 'DRAWINGS'...

DO NOT SCALE

© Crown copyright and database rights 2012.
Ordnance Survey 100021668



Notes

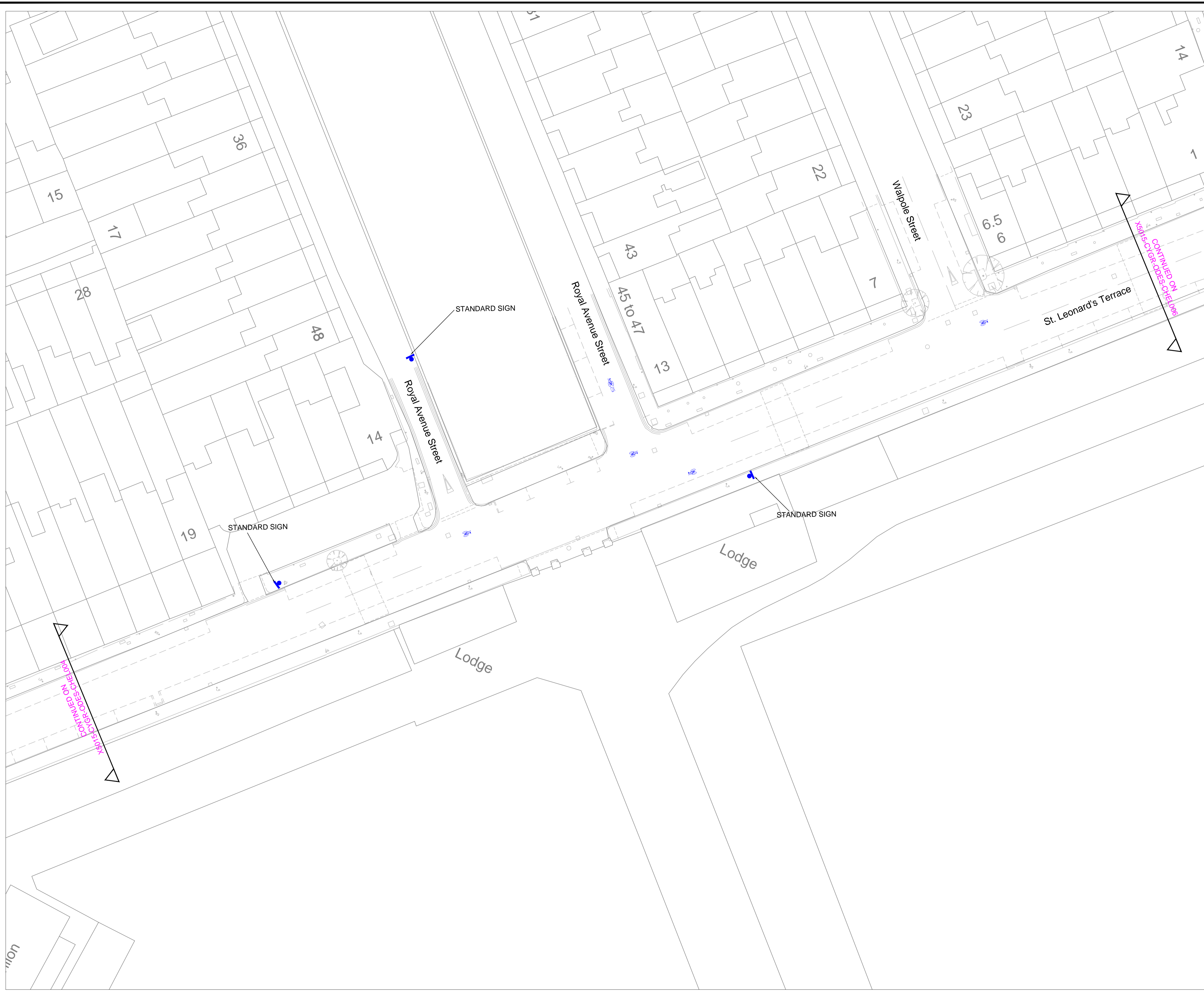

Rev	Description	By	Date	Chk



DEPARTMENT OF TRANSPORTATION
AND HIGHWAYS
Traffic & Transportation Policy Service

The Royal Borough of Kensington and Chelsea
Town Hall, Hornton Street, London, W8 7NX
Telephone: (020) 7361 3374
Fax: (020) 7361 2796

Project
CENTRAL LONDON CYCLING GRID

Title
**RBKC QUIETWAY ROUTE PROPOSALS
CHELSEA QUIETWAY 5 OF 7
(ST LEONARD'S TERRACE)**

Scale 1:250	Drawn EE	Checked Date	19.02.15	Date	A1
Drawing Number X5015-CYGR-ODES-CHEL005	Rev 0				

Cad File : B:\New Server Folder Structure\Scheme\Cycling Grid\07 Scheme development



Notes

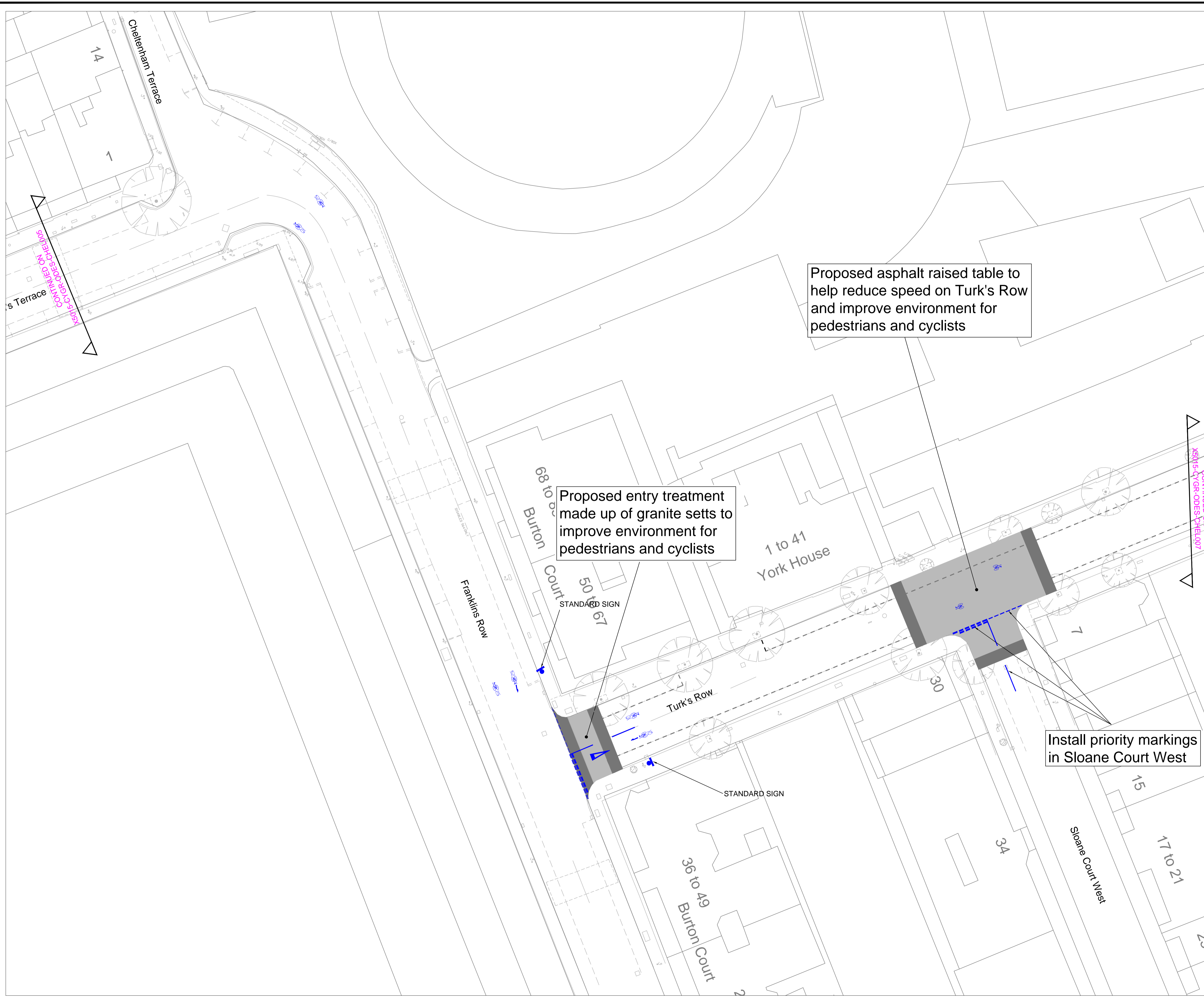

Rev	Description	By	Date	Chk



DEPARTMENT OF TRANSPORTATION AND HIGHWAYS
Traffic & Transportation Policy Service

The Royal Borough of Kensington and Chelsea
Town Hall, Hornton Street, London, W8 7NX
Telephone: (020) 7361 3374
Fax: (020) 7361 2796

Project
CENTRAL LONDON CYCLING GRID

Title
**RBKC QUIETWAY ROUTE PROPOSALS
CHELSEA QUIETWAY 6 OF 7
(FRANKLINS ROW / TURK'S ROW)**

Scale 1:250	Drawn EE	Checked Date	A1
Date	19.02.15	Date	

Drawing Number X5015-CYGR-ODES-CHEL006	Rev 0
---	----------

Cad File : B:\New Server Folder\Structure\Scheme\Cycling Grid\7 Scheme development



Notes

- Footway buildout
- Entry treatment at junction with Lower Sloane Street made up of granite setts
- New pedestrian crossing

Install 1no. 'overrun' area between the zig-zag markings (Flush with carriageway and made of granite setts and kerbs)
See Section Details A below

Install 1no. 'overrun' area between the existing hatched area (Flush with carriageway and made of granite setts and kerbs)
See Section Details A below

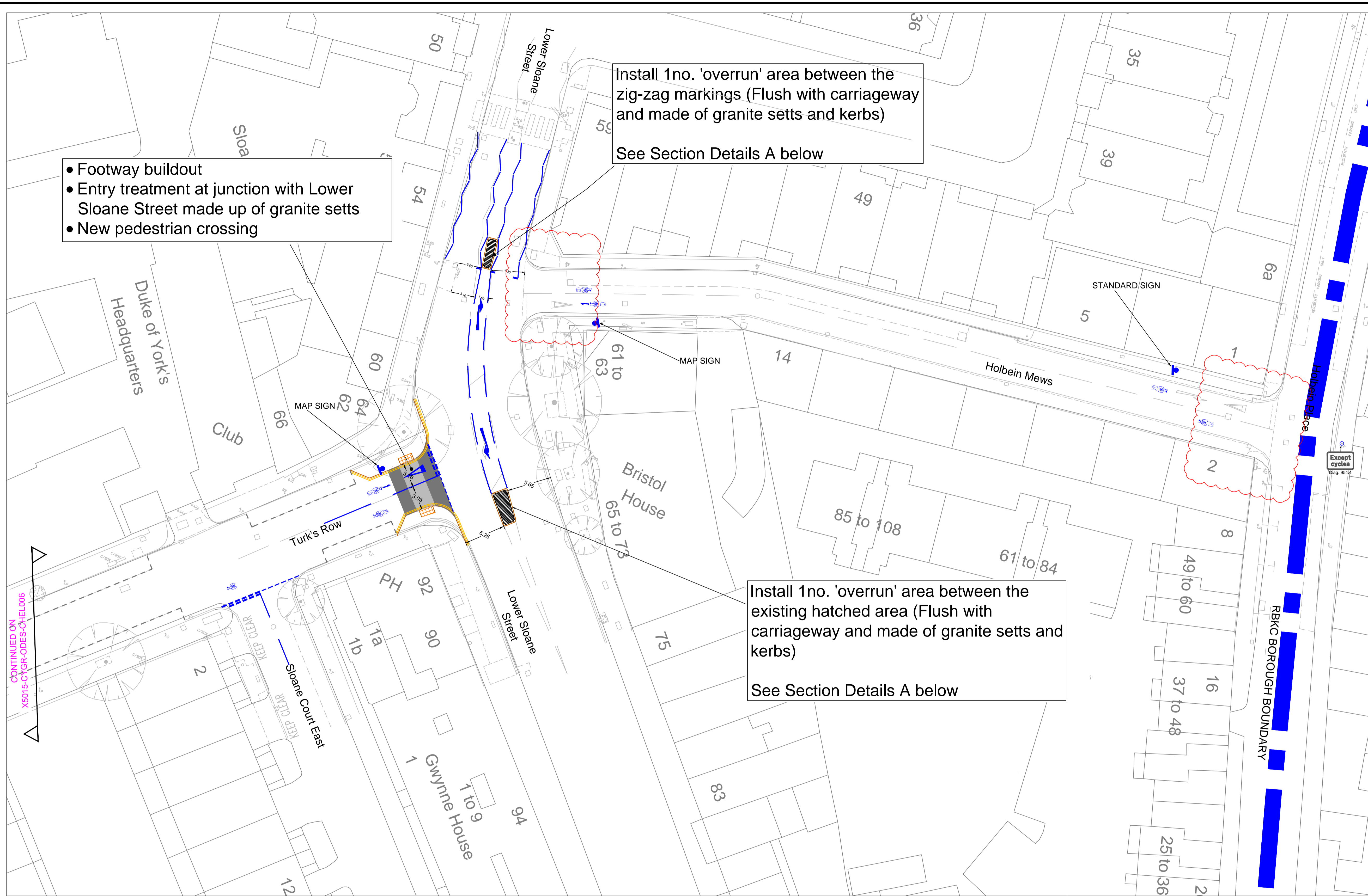

CONTINUED ON X5015-CYGR-ODES-CHEL006

Rev	Description	By	Date	Chk
1	Entry Treatments at Holbein Mews Deleted	EE	03.06.15	

DEPARTMENT OF TRANSPORTATION AND HIGHWAYS
Traffic & Transportation Policy Service

The Royal Borough of Kensington and Chelsea
Town Hall, Hornton Street, London, W8 7NX
Telephone: (020) 7361 3374
Fax: (020) 7361 2796

Project
CENTRAL LONDON CYCLING GRID

Title
RBKC QUIETWAY ROUTE PROPOSALS
CHELSEA QUIETWAY 7 OF 7
(LOWER SLOANE ST / HOLBEIN MEWS)

Scale 1:250	Drawn Date 19.02.15	Checked Date	A1
Drawing Number X5015-CYGR-ODES-CHEL007			Rev 1

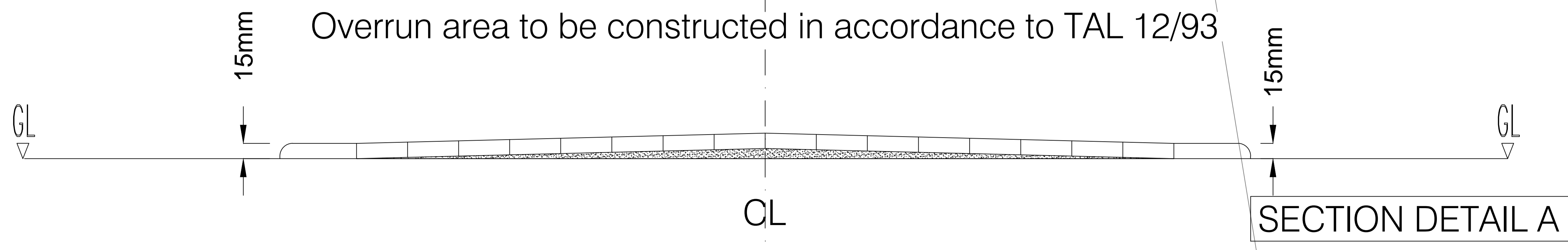

Cad File: \DRAWINGS\...