

LADBROKE GROVE

Project Flourish

Doc. Ref: 167-FAU001-Z-ZZ-DC-A-RP-0001
Revision: P01

Design and Access Statement

Revision	Date	Author	Note
P1	29.09.23	DB	Planning Issue



Applicant

Ballymore (London Arena) Limited
161 Marsh Wall
London
E14 9SJ



Applicant

Sainsbury's Supermarkets
Limited
33 Holborn
London
EC1N 2HT



Architect / Masterplanner

Faulkner Browns Architects
Dobson House
Northumbrian Way
Killingworth
Newcastle upon Tyne
NE12 6QW

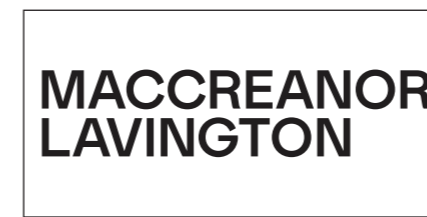

Architect

Maccreanor Lavington
63 Gee Street
London
EC1V 3RS



Architect

Hutchinson & Partners
3.14 The Record Hall
16-16A Baldwin's Gardens
London
EC1N 7RJ



Landscape Architects

Spacehub
7 Gibraltar Walk
London
E2 7LH



Planning Consultant

Rolfe Judd Planning
Old Church Court
Claylands Road
The Oval
London
SW8 1NZ



Heritage Consultant

Turley
Lacon House
84 Theobald's Road
London
WC1X 8NL

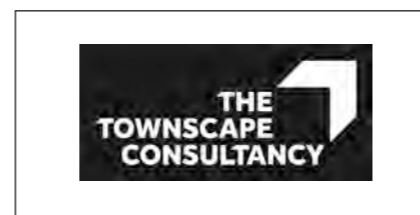

Townscape Consultant

The Townscape Consultancy
Somerset House
Strand
London
WC2R 1LA



Communications

Comm Comm UK
Castle Court
41 London Road
Reigate
RH2 9RJ



Daylight & Sunlight

GIA
The Whitehouse
Belvedere Road
London
SE1 8GA



Transport Consultant

WSP House
70 Chancery Lane
London
WC2A 1AF

Contents

LADBROKE GROVE

Project Flourish

1.0	Introduction	5	8.0	Illustrative Proposals - Plot 4	220	12.2	Fire Strategy	391
1.1	Summary	6	8.1	Design Summary and Explanation	223	12.3	Energy Strategy	393
2.0	Vision Statement	13	8.2	Layout	225			
3.0	The Masterplan	27	8.3	Height & Massing	227			
3.1	Site Assessment	28	8.4	Use	231			
3.2	Community Involvement	53	8.5	Residential Quality	235			
3.3	Masterplan Structure	56	8.6	Building Typologies	239			
3.4	Masterplan Design	74	8.7	Appearance	256			
3.5	Masterplan Phasing	92	8.8	Sustainability	279			
3.6	Existing Buildings on Site	95	9.0	Illustrative Proposals - Plot 1	282			
3.7	Integrating the Carnival	102	9.1	Design Summary and Explanation	285			
3.8	New Neighbourhood Centre	104	9.2	Layout	289			
3.9	The Landscape Masterplan	105	9.3	Height and Massing	295			
4.0	The Process	107	9.4	Use	298			
4.1	Introduction	109	9.5	Amount	302			
4.2	Design Evolution	110	9.6	Residential Quality	303			
4.3	Locating the Store - Design Evolution	115	9.7	Appearance	305			
4.4	Supplementary Planning Document	120	9.8	Sustainability	317			
4.5	QRP Feedback	130	10.0	Illustrative Proposals - Plot 5	320			
4.6	The Design Teams	141	10.1	Design Summary and Explanation	323			
5.0	Masterplan and Plot Overview	148	10.2	Layout	327			
5.1	Introduction	150	10.3	Height and Massing	333			
5.2	The Masterplan - Outline and Detail Elements	151	10.4	Use	335			
5.3	Sustainability	153	10.5	Amount	339			
6.0	Detailed Proposals - Plot 2	156	10.6	Appearance	340			
6.1	Introduction	159	10.7	Sustainability	345			
6.2	The Store	162	11.0	Illustrative Proposals - Plot 6	348			
6.3	Podium Buildings	178	11.1	Design Summary and Explanation	351			
7.0	Illustrative Proposals - Plot 2	188	11.2	Layout	355			
7.1	Residential Buildings	191	11.3	Height and Massing	359			
7.2	Technical Considerations	200	11.4	Use	363			
7.3	Building 2.9 : Sports Pavilion	209	11.5	Amount	365			
			11.6	Appearance	367			
			11.7	Sustainability	373			
			11.8	Kayak Pavilion (Plot 6.2)	375			
			12.0	Appendices	384			
			12.1	Access Statement	385			

1.0 Introduction

1.1	Summary	6
1.1.1	Preface	6
1.1.2	The DAS Structure	8
1.1.3	The Overall Application Structure	8

1.1 Summary

1.1.1 Preface

This report is prepared in support of the hybrid planning application for the land within the Kensal Canalside opportunity area owned by the joint venture partnership of Ballymore (London Arena) Limited and Sainsbury's Supermarkets Limited. This Design and Access statement, co-ordinated by Faulkner Browns Architects and including work by the wider design team and consultants, aims to present the site context, design journey and design principles for the masterplan.

Our work, titled Project Flourish, is presented as a hybrid planning application (which is comprised of part outline and part detailed applications), and includes a masterplan vision for the Application Site, detailed designs for plot 2 (store only) and areas of the landscape and road network and outline designs, incorporating design codes, for Plots 1,2,4, 5 and 6.

The illustrative masterplan conveys one way in which the Application Site could come forward, in accordance with the accompanying parameter drawings and Design Code.

1.1.1.1 Introduction

The development proposals for Project Flourish aspire to create a vibrant, sustainable, and contextually appropriate mixed-use scheme that will transform this important part of West London into a characterful, accessible, and integrated part of the city.

The new development will deliver homes, jobs, high quality public open spaces, commercial and leisure destinations to be enjoyed by the new population of the Application Site and the existing residents of the local area.

The scheme forms part of the 'Kensal Canalside Opportunity Area' and is therefore earmarked for major mixed use development. Currently, the Application Site is broadly split into three parts. The western part sits derelict and is an underutilised brown field site. The eastern part of the Application Site is occupied by a Sainsbury's superstore, car park and petrol filling station (PFS) and the north eastern corner is currently owned by RBKC and contains Canalside House and the Boathouse Centre.

The existing site contains an access road, known as Canal Way, which provides access to the Sainsbury's Store and car park, a Network Rail compound and an infrastructure site to the far west. Adjacent to the Application Site and outwith the application boundary is land owned by Berkeley St William, which contained the now removed Gas Holders. This area is known as Plot 03 but does not form a part of this application. Please refer to chapter 3 for a detailed description and layout plan to describe the existing land ownerships.

The application aims to reconnect the existing site to the surrounding area through an improved road junction at Ladbroke Grove which will be secured through a Section 278 agreement within the planning application.

The application safeguards the location for a future pedestrian and cycle connection across the train tracks to the North Pole site. The layout acknowledges a pedestrian and cycle bridge to connect the existing site westward to Kensal Green cemetery, which would provide a more direct access from the northern Opportunity Area to Kensal Green tube station. These bridges do not form a part of this application.

A key part of the design brief relates to the relocation of the Sainsbury's store and the need to maintain the store in operation whilst a new store is built. The masterplan layout is arranged such that the new store sits directly to the west of the existing store allowing the existing store and car park to be accessed during the construction phase. Once the new store is relocated at the centre of the masterplan, the existing store will be demolished and the buildings within the eastern portion of the Application Site will be brought forward.

We see this eastern portion of the masterplan as the neighbourhood centre, a space for shops, businesses, leisure facilities and services for the new residents on the Application Site and the existing neighbours to the site. Our approach sets the new store entrance at the head of an avenue, activated by customers travelling to and from the store. This approach enables the mixed development to be integrated into the Application Site in a format that is respectful of context and appropriate to the needs of surrounding communities.

The proposals in this planning application have been developed in response to many years of design development and stakeholder engagement. The proposals are the result of collective reflection on all responses to previous design iterations. The shape, content and quantum of development balance commercial requirements, community need, planning policy, local opinion and complex site constraints. The proposals define a scheme that is deliverable and appropriate and delivers value to all.



1.1.1.2 An Introduction to the client

This application has been prepared by a joint venture partnership between Ballymore (London Arena) Limited and Sainsbury's Supermarkets Limited, landowners of the largest portion of land on the northern part of the Kensal Canalside Opportunity Area (KCOA). The partnership intends to bring development forward as soon as the necessary planning approvals are in place.

Ballymore is a family-run property developer with an award-winning portfolio of some of Europe's largest and most transformative urban development projects. A privately owned company, Ballymore was established by Chairman and Group Executive Sean Mulryan in Dublin in 1982.

Ballymore's projects are defined by their originality and commitment to quality. The company oversees every element of design, construction and facilities management.

Recent developments include London City Island, Embassy Gardens, Warden London, Goodluck Hope, Brentford, Royal Wharf and Three Snowhills.

Sainsbury's has considerable experience of delivering mixed use developments across London. Their development at Fulham Riverside, Townmead Road, Fulham, regenerates their own site and an adjacent redundant brewery site delivering private and affordable housing set within new public realm together with a new store. At Nine Elms Vauxhall, they have recently completed construction of a new store that regenerates their former store into a major mixed use scheme including the integration of a new underground station serving the area. The proposals again deliver private and affordable housing above and around a new store with a series of landmark buildings. As with Fulham Riverside, car parking has been placed beneath the store to enable the creation of public realm around the entire development. The Hyde, shown above, is a recently approved mixed use scheme comprised of approximately 1,300 homes and a new Sainsbury's Store beneath. With all of these schemes, the regeneration and enhancement of the public realm that surrounds the development have been core principles of the development, and key to their success.

1.1.1.3 Purpose of this document

This Design and Access Statement (DAS) has been prepared as part of a suite of documents to support the planning application for the redevelopment of the Kensal Canalside Application Site. This document provides a summary narrative that explains all facets of the proposals relating to the applications for both outline and detail planning permission.

The proposed Development will create a remarkable environment unique to North Kensington, it will deliver new homes and jobs, quality open space, and community facilities to benefit the local neighbourhoods in the Royal Borough of Kensington and Chelsea (RBKC) and London as a whole.

The masterplan has been developed to enable phased development to allow for a meaningful place to be created in each phase and to grow the community in stages.

This DAS describes the masterplanning process. Its structure is based on the format recommended by the Commission of Architecture and the Built Environment guidance 'Design and Access Statements: How to write, read and use them' (2006). The requirements of the following are also complied with in this document: Town and Country Planning (Development Management Procedure) Order 2015 (DMPO), 'The London Plan 2021, 'Accessible London: Achieving an Inclusive Environment'(April 2011), the 'Mayor of London Access Statement Content Guidance'.

The application is a hybrid application with detail submitted for much of the ground and basement levels of Plot 2 together with elements of the landscape and road network. For these elements, planning permission is being sought for all aspects and drawings are being submitted for approval. Plots 1, 2 (the residential elements), 4, 5 and 6 are to be submitted in outline. For the Outline elements, all matters are reserved and reserved matters applications will be brought forwards in accordance with parameter plans (being submitted for approval now), the Development Specification and the mandatory elements of the Design Codes which will be secured by planning condition.



Fig 1.1: The Hyde, Hendon, Sainsbury's



Fig 1.2: Goodluck Hope



Fig 1.3: The Brentford Project



Fig 1.4: Goodluck Hope

1.1.2 The DAS Structure

The DAS is structured into 12 parts.

1.0 Introduction

2.0. Vision Statement.

An introduction to the project, the client team and the proposed application.

3.0. The Masterplan

Illustrative Masterplan and Buildings: This section describes the indicative design proposals that have been prepared to test the parameters that the outline application seeks approval for. These indicative designs provide the basis for the Design Code submitted separately. This chapter includes a description of the Application Site movement strategy.

4.0. The Process

The design evolution, background research, site analysis and design timeline, incorporating responses to the Quality Review Panel and Kensal Canalside Opportunity Area Supplementary Planning Document.

5.0 Plot Design

An overview of the plot designs within the context of the overall application.

6.0. Detailed Proposals - Plot 02

A design briefing by Hutchinson and Partners to describe the detailed elements on Plot 02.

7.0. Illustrative Proposals - Plot 02

8.0. Illustrative Proposals - Plot 04

9.0 Illustrative Proposals - Plot 01

10.0 Illustrative Proposals - Plot 05

11.0 Illustrative Proposals - Plot 06

12.0 Appendices

1.1.3 The Overall Application Structure

The proposed application may be described as follows:

A hybrid application for the demolition of all existing buildings and structures to facilitate a mixed use development comprising residential, retail, commercial and community uses with associated infrastructure.

The outline element of the scheme will include residential floorspace and ancillary residential facilities (Class C3) and non-residential floorspace comprising flexible commercial, community and sui generis floorspace (Class E / Class F2 / Sui Generis), the provision of new pedestrian and vehicular access, open space, landscaping, car and cycle parking and other associated infrastructure works with all matters reserved for future consideration.

The detailed element of the scheme will comprise a large retail store and ancillary facilities (Class E(a)), Commercial, Business and Service uses (Class E), Leisure floorspace (Class E(d)), residential facilities (Class C3), improvements to existing site access at Ladbroke Grove, provision of new pedestrian and vehicular access, internal roads and associated landscaping, car and cycle parking and associated infrastructure works including remediation.

The documentation submitted for approval, including the Parameter Plans (PP), Development Specification and the Design Code contain the overall Parameters and Principles for the masterplan and specifically the outline plots. These constitute a robust framework which will facilitate future detailed design and the assessment of Reserved Matters applications.

The Design Code that accompanies this application provides 'mandatory' rules and 'recommended' guidelines for both the individual plots and the areas of landscape outside of the detailed boundary. These rules will govern the future reserved matters applications as schemes move forward in detail.

The DAS has been prepared to illustrate the design process that has led to the development proposals, and to explain and justify the design framework which in turn has informed the Design Code.

The Illustrative Masterplan (IMP) contained within the DAS is prepared to demonstrate one way in which the scheme could be developed in accordance with the Parameter Plans, Development Specification and the Design Code which will be conditioned.

1.1.4 Terminology

A set of key terms which are used throughout this document are clarified below:

- **Masterplan** - Refers to the detailed and illustrative proposals within the Application Site which convey the overall design concepts.
- **Application Site** - The land within the red line application boundary.
- **The Proposed Development** - Refers to the proposals submitted in detail and the outline proposals conveyed on the Parameter Plans within the red line application boundary.
- **The Team** - Refers to the applicant team comprised of Ballymore and Sainsbury's, together with the consultant team. The core consultant team are shown on page 2 of this document.
- **Plot 03** - Land owned by Berkeley St William and subject to a separate planning application. The scheme has been shown at various points in this document to convey how the plot will be integrated into the wider masterplan. No application has yet been submitted for this site and as such all massing and layouts shown are indicative and based on the latest available information.



Fig 1.5: The Site and surrounding area

Key:

- The Application Boundary
- Plot 03
- The northern section of the Kensal Canalside Opportunity Area
- The southern section of the Kensal Canalside Opportunity Area (known as the North Pole site)

Vision Statement

The opportunity

The redevelopment unlocks the opportunity to:

- Rejuvenate a former utilities site into a unique location that connects with its surroundings.
- Facilitate new connections between the site and the surrounding areas in the form of new pedestrian routes and bridges
- Create a new neighbourhood centre that meets the needs of a new population as well as the existing population of the local area.
- Rationalise the land currently used to house a Sainsbury's superstore and create space for much needed housing.
- Provide a new modern superstore that serves the local community.
- Create a sequence of new public spaces that cater for residents and visitors and make positive connections to the local area.
- Celebrate the unique location and geography of the site and connect the cemetery and canal, the train track and Ladbroke Grove into a new place in North Kensington.

Our guiding principles

To help us realise our vision and bring Project Flourish to life we have developed our proposals around the following guiding principles:

1. Connect **harmoniously** with the existing character of the surrounding context to create a development that is an authentic response to a rich and varied context.
2. Respond **generously** to the context improving connections for new residents and for residents and visitors from the surrounding area.
3. Shape a development strategy that will have a **positive impact** for the site both in the short and long term.
4. Create a masterplan that allows people to **flourish** with access to a rich mix of uses and opportunities and as such create a sustainable place for years to come.
5. Adopt **sustainable** principles for design through all our endeavours, from urban design, through to the building fabric of the completed project.

Project Flourish seeks to redevelop one of the last remaining large brownfield sites in the Royal Borough of Kensington and Chelsea and in so doing create a new neighbourhood which compliments the locality and the wider section of north-west London and creates a special new place where people thrive.



1. Connect harmoniously with the existing character of the locality to create a development that is an authentic response to a rich and varied context.

The site has a unique and varied context. To the north and west is Kensal Green Cemetery, one of London's magnificent 7 cemeteries. The cemetery sits alongside the Grand Union Canal, an important heritage feature and part of the story of the development of the site as a gas works in the 1830's.

To the east Kensal Town, sometimes referred to as 'Soapsuds Island' due to its unique geography and its former life as a hub for industrial laundries. Kensal Town is now home to a rich mix of different creative industries and workplaces as well as schools and homes.

To the south lies the Great Western Railway mainline rail artery, a major rail artery connecting London to South and West England and Wales. With long south facing views across the city and an opportunity to facilitate a bridge connection to the south we can open up this part of the site to make a positive contribution to the wider area.

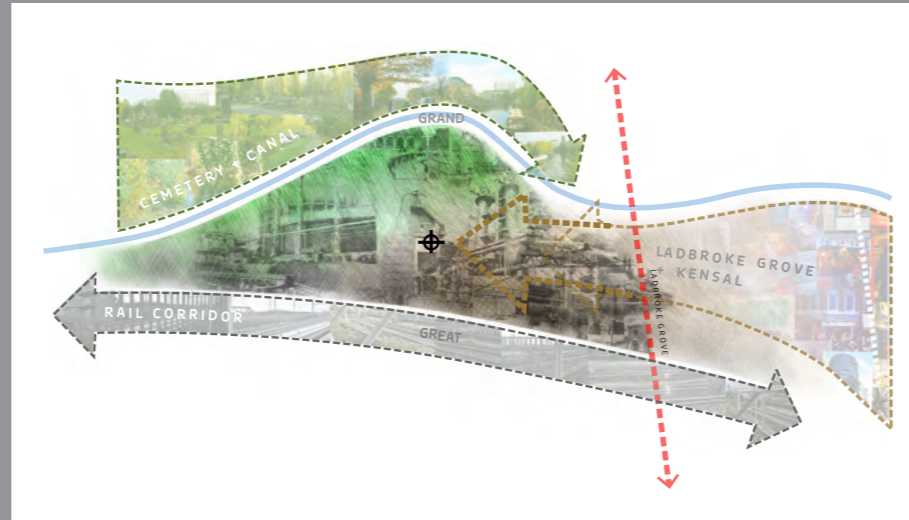

Fig 2.1: Concept sketch - analysing the varied context



Fig 2.4: The Grand Union Canal and Kensal Green Cemetery looking towards the Boathouse Centre

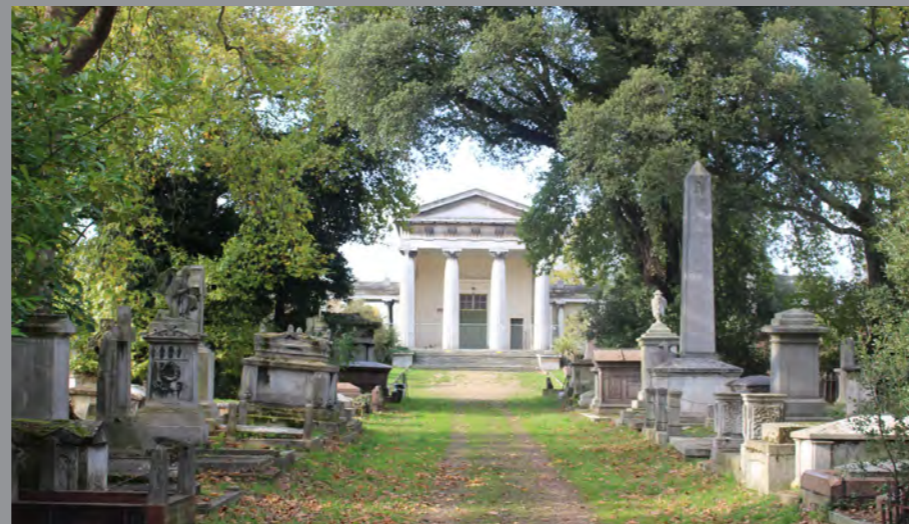

Fig 2.2: The central route through the cemetery with the Anglican Chapel to the rear of the image.



Fig 2.3: Kensal House, the site's nearest residential neighbour.







2. Respond generously to the context improving connections for new residents and for visitors from the surrounding area.

Our plans aim to celebrate the canal edge environment with landscape connections that compliment the canal towpath and offer new ways to interact with the water and the trees which line the canal. We aim to reinstate the former canal basin to create a new public realm feature at the centre of the site.

There is the opportunity to make new connections to the wider area via bridges to the south and west (subject to agreement with neighbouring landowners). The masterplan safeguards land for the southern bridge over the railway to the Department for Transport land.

A new garden at the entrance of the site at Ladbroke Grove aims to make a positive connection to the existing street network and the wider neighbourhood, providing an accessible green space for the existing community.

3. Shape a development strategy that will have a positive impact in the short and long term.

The Sainsbury's store is an important part of the local community and its operation will be maintained throughout the construction process. Our first phase of development will deliver the replacement store and the new canal basin in order to create a new destination as early as possible in the site's development.

Our new garden at the entrance of the site will provide space for both local residents and new residents. It will provide a flexible green space as well as play space for children. A new building will provide community and cultural facilities that connect to the landscape.

A site wide strategy for temporary uses, events, arts and creative industries has been established that will invigorate the site through the construction process and beyond.

The site is the only London Plan Opportunity Area not to have been developed and therefore it is strategically important to meeting London Plan objectives.



Fig 2.5: The new garden space at the entrance of the site







Fig 2.6: A diagram to show the proposed ground floor activity as part of the eastern neighbourhood centre.

4. Create a masterplan that allows people to flourish with access to a rich mix of uses and opportunities and as such create a sustainable place for years to come.

The development team recognise that a sustainable place depends on designing an area that incorporates space for a wide range of businesses and allowing young people and creative businesses to flourish.

We intend to create a neighbourhood centre that is relevant to the local area and the new population on site.

The masterplan provides space that could be used for a wide variety of everyday facilities such as a pharmacy, a dentist and childcare facilities.

5. Adopt sustainable principles for design through all our endeavours, from urban design, through to the building fabric of the completed project.

Using the guiding principles: Social, Human, Physical, Natural, Economic we embed sustainable design principles at all scales. These principles aim to guide us in response to both global challenges and local policies in relation to sustainable development.

Our physical principle relates to our strategies for managing whole life carbon, creating a place that can adapt to future climates and integrate sustainable transport systems and reduce reliance on cars.

Social sustainability relates to our goal to design places for people, promote active engagement and community connections as well as a public realm that is accessible, inclusive and safe.

Economic Sustainability relates to our plans to reduce maintenance and energy running costs, our goals to support the local economy and the careful procurement of products and resources.

We aim to enable physical and mental wellbeing through our human design principle, linking landscape and nature with new homes and designing buildings which are acoustically and thermally comfortable.

Our natural design principle relates to our plans for whole life resource efficiency, the enhancement of biodiversity and ecological value.



Fig 2.7: The South Terrace looking west



The Golden Mug

Bakecrafty

Emporium

Coffee

Bakecrafty

<h1>3.0 The Masterplan</h1>			
3.1	Site Assessment	28	
3.1.1	Overview	28	
3.1.2	The Site Location	28	
3.1.3	Site Ownership	30	
3.1.4	Site History	36	
3.1.5	Local Context	44	
3.1.6	The Opportunity Area, Site allocation and the SPD	46	
3.1.7	Site Constraints	47	
3.1.8	Site Opportunities	48	
3.2	Community Involvement	53	
3.2.1	Community Consultation	53	
3.3	Masterplan Structure	56	
3.3.1	Introduction	56	
3.3.2	Key Principle 01: Connections	58	
3.3.3	Key Principle 02: Character and Context	60	
3.3.4	Key Principle 03: Locating the Store	64	
3.3.5	Key Principle 04: Activation	66	
3.3.6	Key Principle 05: Open Space	70	
3.3.7	Key Principle 06: Block Structure	72	
3.4	Masterplan Design	74	
3.4.1	Summary	74	
3.4.2	The Ground Plane	75	
3.4.3	Movement and Connectivity	76	
3.4.4	New Neighbourhood Centre	82	
3.4.5	Environmental Quality	84	
3.4.6	Key Principle 07: Height and Massing	85	
3.5	Masterplan Phasing	92	
3.5.1	Summary and Approach	92	
3.6	Existing Buildings on Site	95	
3.6.1	Existing Sainsbury's Store	96	
3.6.2	New Sainsbury's Store	97	
3.6.3	The Site Entrance	98	
3.6.4	Boathouse Centre	99	
3.6.5	Canalside House	100	
3.7	Integrating the Carnival	102	
3.7.1	Existing Condition	102	
3.7.2	Proposed Condition	103	
3.8	New Neighbourhood Centre	104	
3.8.1	Overview	104	
3.9	The Landscape Masterplan	105	
3.9.1	Overview	105	

3.1 Site Assessment

3.1.1 Overview

This section of the Design and Access Statement describes and assesses the site's current condition, its relationship to its immediate surroundings and its wider city context and the current masterplan.

The site and its relationship to local geography is unique in that the land is presented as an island, divided by the canal and the railway to the north and south and by the busy Ladbrooke Grove in the east.

Section 3.1.5 sets out the Design Team's analysis of Kensal's history and the Site and surrounding area's evolution. We aim to highlight the component parts that contribute to the character of this new part of the city. It also considers the sites unique relationship with the canal and cemetery, the wider Kensal Town to the east and the train tracks to the south.

The local context and the site are explained and analysed in sections 3.1.4, in terms of its townscape, history, opportunities and constraints. This detailed review sets the scene for the design direction of the proposals to provide a deep understanding of the existing site condition and the designs relationship to context. It also aims to prepare a strong foundation on which the decision can be taken to ensure that proposals are authentic and generous to the context.

This analysis and its conclusions then inform the current masterplan which is explored in section 3.3.

3.1.2 The Site Location

The site is located in the Kensal Canalside Opportunity Area (KCOA) which is in the far north of the Royal Borough of Kensington and Chelsea (RBKC). Close to the convergence of 3 other London boroughs (Brent, Hammersmith and Fulham and Westminster) and the Old Oak and Park Royal regeneration area (OPDC).

The KCOA has an area of approximately 15 hectares of which the land owned by Ballymore/Sainsbury is approximately 7.6 ha. The opportunity area is divided in ownership across several landowners including National Rail, The Department for Transport, National Grid/ Berkeley St William, RBKC and Ballymore/ Sainsbury's. (See fig 3.4)

There is a single vehicular access into the site from Ladbrooke Grove, with pedestrian access also along the Grand Union Canal. There are currently no north south connections across the railway lines or the canal.

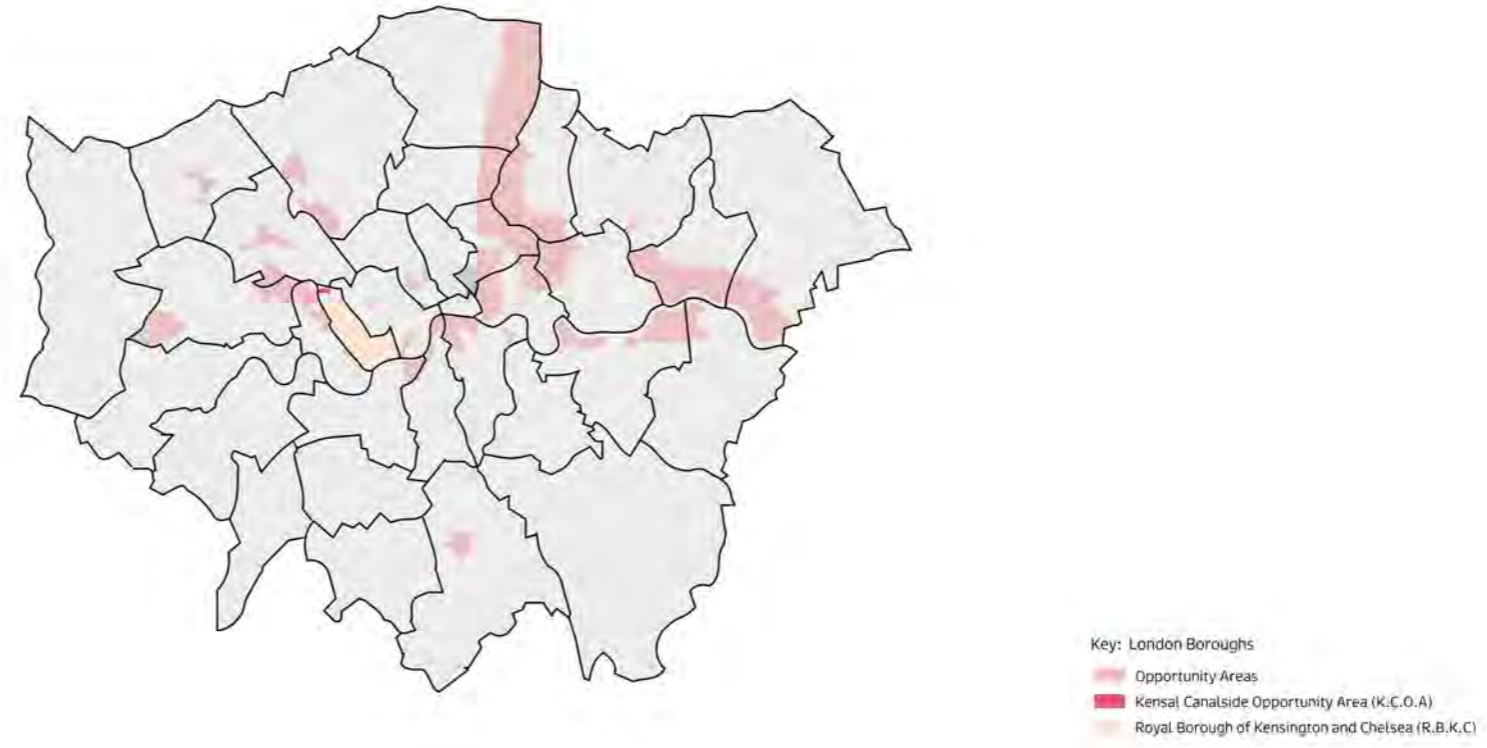

Fig 3.1: A map of the London Borough boundaries



Fig 3.2: The site within the wider context of RBKC



Fig 3.10 - Surrounding area Aerial photograph

3.1.3 Site Ownership

The adjacent diagram describes the current land ownership relationship both on the Site (red line boundary) and in the surrounding area.

The majority landowners of the Site are Ballymore and Sainsbury's. To the east, the RBKC owned land forms part of the Site subject to this application, alongside the Ballymore and Sainsbury's land.

To the west, Berkeley St William own the former gas holders site. This area is not part of the planning application.

The southern site, known as the North Pole site, is owned by the Department for Transport, and spans a long thin space between Barlby Road and Scrubs lane. This area does not form part of the application. The eastern end of the North Pole site is within the KCOA, the western end is within the Old Oak and Park Royal Development Corporation.

- Key**
- Ballymore
 - Sainsbury's
 - Berkeley St William
 - Network Rail
 - RBKC
 - Department for Transport
(North pole Depot)
- a The Boathouse Centre
 - b Canalside House
 - c The Water Tower (Privately owned and not part of the application boundary)



Fig 3.4: Existing site ownership



- Key**
- ① Ballymore
 - ② Sainsbury's
 - ③ Berkeley St William
 - ④ Network Rail
 - ⑤ RBKC
 - ⑥ Department for Transport
(North pole Depot)

Fig 3.5: An aerial view of the Site and surrounding area taken in Spring 2021

3.1.3.1 The Sites Spatial Structure and Character

The adjacent image shows the current site and surrounding area configuration. The aerial photo taken in 2020.

- ① The Site entrance
- ② Petrol Filling Station
- ③ Store Carpark
- ④ Canalside House
- ⑤ Boathouse Centre
- ⑥ Portobello Dock
- ⑦ Sainsbury's Store
- ⑧ Grand Union Studios
- ⑨ Kensal House
- ⑩ 'North Pole' Site - Owned by Department for Transport
- ⑪ Dissenters' Chapel
- ⑫ Anglican Chapel
- ⑬ Great Western Mainline
- ⑭ Network Rail Site
- ⑮ Kensington Gas Works
- ⑯ Trellick Tower
- ⑰ Kensal Green Substation
- ⑱ Little Wormwood Scrubs







Fig 3.8: A view eastward towards Ladbroke Grove road bridge.



Fig 3.9: The existing bridge over the former canal basin

Fig 3.7: An image of the site taken from Kensal Green Cemetery in April 2020. The former gasholder (demolished June 2021) is shown in the foreground.



Fig 3.12: Sainsbury's car park



Fig 3.10: The existing site entrance

Fig 3.11: The Great Western mainline

3.1.4 Site History

Kensal Green is first mentioned by its present name in 1550, but by the 18th century, it was still a minor settlement along the Harrow Road within a wider rural or countryside setting. However, the 19th century saw the area transformed by transport infrastructure which in turn encouraged urban development, particularly industrial and also supporting residential.

In 1832, land to the north of the site was developed for Kensal Green Cemetery and in 1838 the railway line was installed to the South. The Canal, originally called the Paddington Canal, was opened in 1801.

As the development of London spread out from its centre, development in this area was focused on the Harrow Road, as seen on the 1870 and 1890 maps of London. Kensal Green, Kensal New Town and Westbourne Green, were, at that time, distinct villages within the local area.

From the mid 19th century, London rapidly expanded and terraced housing was built to the North and south of the site. The western edge of Queens Park being a significant development.

The gasworks, established in 1845 expanded quickly on the site, and has over the years, changed and developed according to the intensity of its use and the methods and technology related to create gas from coal. The two large gas holders, a feature of the existing site until very recently (demolished 2021) were installed in the 1920's.

The gas works closed in 1970, the site was cleared, and a Sainsbury's store was opened in 1989.

3.1.4.1 The Cemetery

To the north of the canal, the General Cemetery Company had in 1831 bought fifty-four acres of land for use as a burial ground. The 1832 opening of the distinctively picturesque All Souls' Cemetery at Kensal Green; planned as the first of seven "magnificent" new cemeteries out of the centre and city wide, again brought more employment and encouraged building. Within this designed landscape the competition for the cemetery buildings was secured by J.W. Griffiths, and his designs for a non-conformist chapel (the Dissenters Chapel), the entrance gateway and lodges and the perimeter wall were realised by June 1834. The centrepiece Anglican Chapel, also designed by Griffiths, was subsequently completed in 1837. This cemetery was a direct response to the cholera epidemic of the late 1820s and the poor condition of central London graveyards.

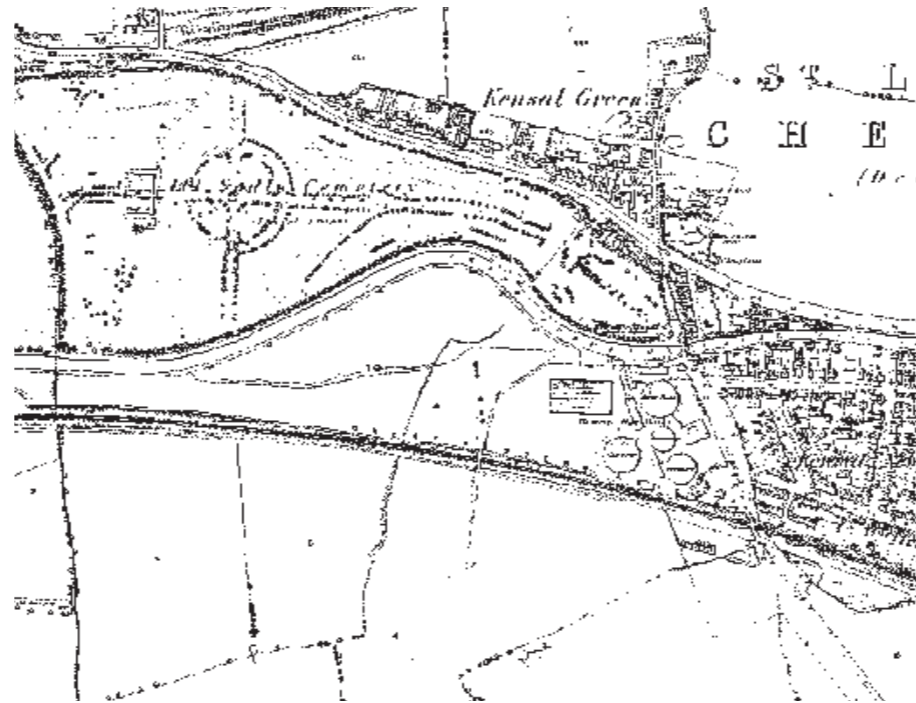

Fig 3.13: Mapping 1870



Fig 3.14: Mapping 1890



Fig 3.15: Mapping 1910



Fig 3.16: Mapping 1930



3.1.4.2 Former Industrial Use

The following pages illustrate some of the former industrial buildings which once occupied and characterised the site. The influence of this heritage is reflected within a number of the illustrative building designs as explained within the plot design sections which follow.



Fig 3.18: Aerial view of former Gas Works site viewed from the south



Fig 3.17: Aerial view of former Gas Works site viewed from the west

3.1.4.3 Historic Building Character

The historic site contained a range of industrial buildings which characterised the site and skyline. The proposed buildings, particularly those on Plot 05 have sought to respond to this industrial character, through their position on site, the way in which they are massed, and even within their architectural detailing. Plot 2.6 has also been positioned intentionally to respond to the historic grain of the site and references the roof pattern of former warehouses on the site and at the adjacent Portobello Docks.



Fig 3.21: Former industrial buildings fronting the Great Western Mainline

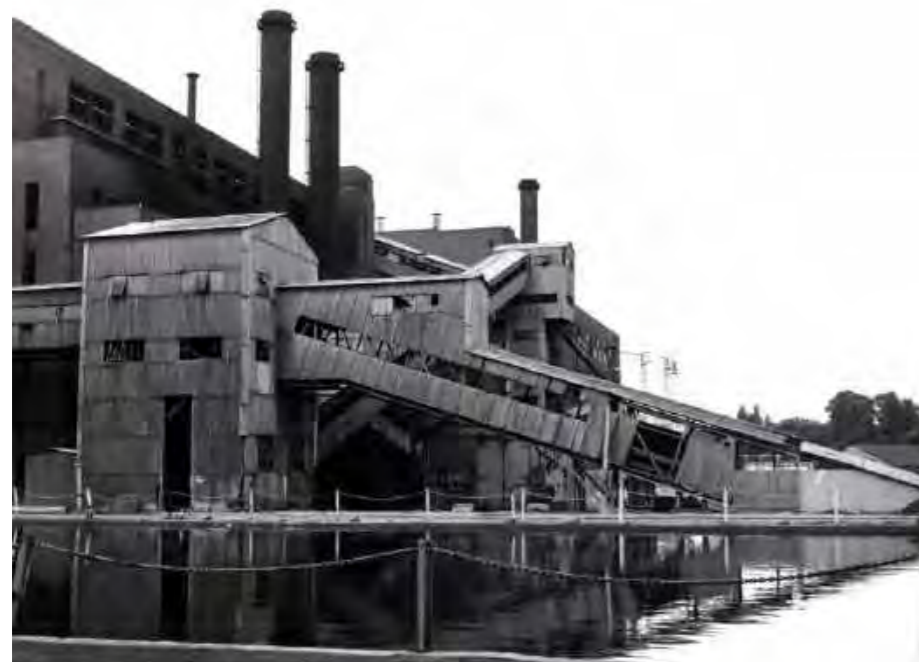

Fig 3.22: Gas works buildings c.1970



Fig 3.20: Former industrial buildings fronting the canal



Fig 3.19: The site, prior to the construction of Kensal House

3.1.4.4 Building Scale

The former buildings on site presented a scale which was distinct against the wider character of the borough but which became familiar silhouettes on the skyline. The gas holders ranged in scale from approximately 50m tall (the tallest of the recently demolished gas holders) to an estimated 70m tall on the eastern edge of the masterplan, in close proximity to Kensal House.



The former gasholder at the western end of the site (demolished in 2021) was 50m tall.

The former gasholder behind Kensal House was approximately 70m tall.



Fig 3.24: A 1950's era photograph of the gasworks viewed from the west

Fig 3.23: A 1920's era photograph of the site, with Kensal House under construction in the foreground

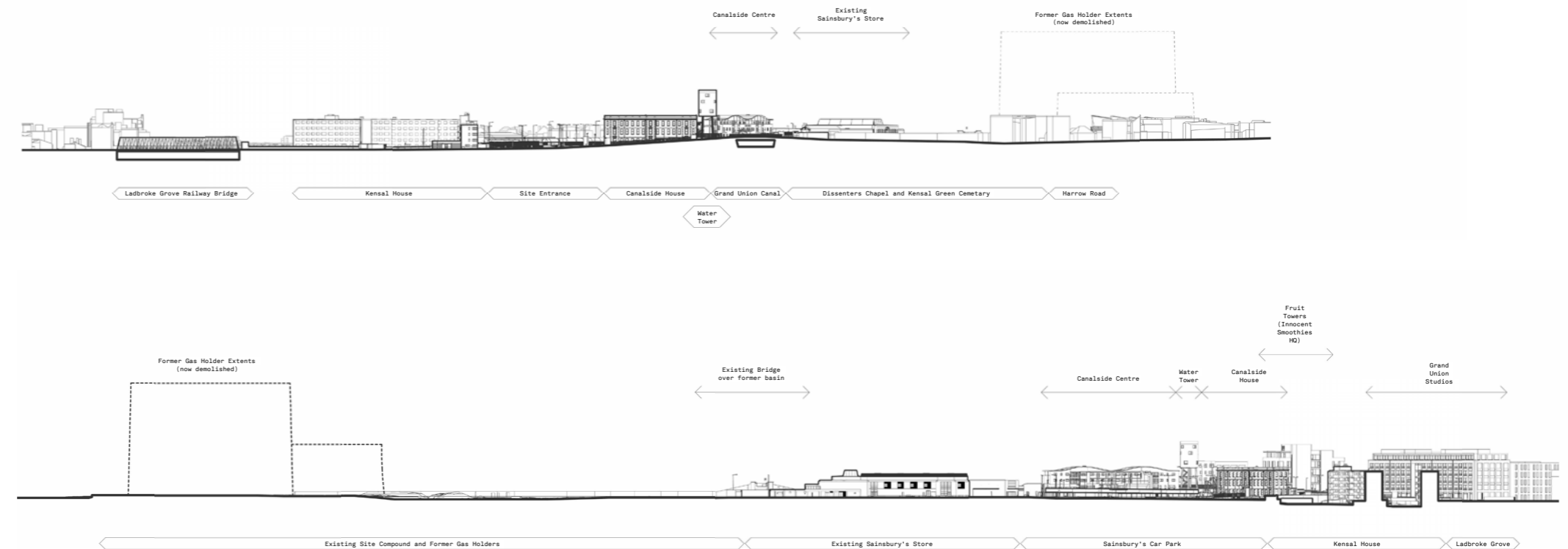

Fig 3.25: Site sections showing the scale of the former gas holders in the context of existing buildings on site

3.1.4.5 TV and Film

The following images illustrate where the site has appeared in TV and film in recent history. Often positioned within the cemetery, the stills illustrate the prominence of the former industrial heritage now removed.

Images from film stills

- 1 + 2. Steptoe and Sons Ride Again (1973)
- 3. Fleabag (2016)
- 4. The Lady in the Van (2015)
- 5. Look Back in Anger (1959)



Fig 3.26: 1 + 2. Steptoe and Sons Ride Again (1973)



Fig 3.27: 2. Steptoe and Sons Ride Again (1973)



Fig 3.30: 3. Fleabag (2016)



Fig 3.29: 4. The Lady in the Van (2015)



Fig 3.28: 5. Look Back in Anger (1959)

3.1.4.6 Historic Context

3.1.4.7 Kensal Green Conservation Area

The heritage significance of this conservation area is derived from the famed Kensal Green (All Souls) Cemetery. This was the first picturesque garden cemetery to be built outside London in the early 19th century – as part of the ambitious scheme to construct seven new metropolitan cemeteries for the city. The designated area includes a large number of Listed Buildings across all grades (including the main Entrance Gateway, Northern Colonnade, Anglican Chapel, Dissenter’s Chapel, Perimeter Walls and extensive collection of mausolea and funerary monuments); all within the boundaries of the Grade I Registered Park and Garden. Together these designed landscape and architectural elements create an historic ensemble of exceptional interest, which is still operated and maintained within the ownership of the General Cemetery Company. The later western extension of the original 1830s cemetery falls outside this conservation area but within the boundary of the adjoining St Marys Conservation Area (LBHF).

3.1.4.8 Oxford Gardens and St Quentin *

The significance of the Conservation Area is derived, principally, from its attractive streets and groups of residential properties dating from the late 19th and early 20th centuries within the area of North Kensington. The later 19th century development of the St Marylebone Infirmary (now St Charles Hospital) towards the north east edge of the Conservation Area is also a distinctive feature of this townscape, including its local landmark water tower (central administration block). Overall this Conservation Area is unusual among those within the RBKC as it contains very few Listed Buildings.

3.1.4.9 Queens Park *

The Queen’s Park Estate is a large and well preserved area of picturesque Victorian cottage style housing with the townscape characterised by its overall homogeneity and intimacy of scale. The terraces utilise a shared palette of materials with Gothic detailing repeated in different combinations to provide vitality in the townscape. Terraces are set aside wide tree lined streets with small front gardens and boundary walls. There are few other uses and there is a limited amount of traffic which gives the area a peaceful residential atmosphere. There is an awareness of the heavily trafficked Harrow Road in the southern part of the Conservation Area.

* An extract from the Turley Heritage Baseline Appraisal.



Fig 3.31: The central avenue looking west to the chapel



Fig 3.33: The Dissenters' Chapel

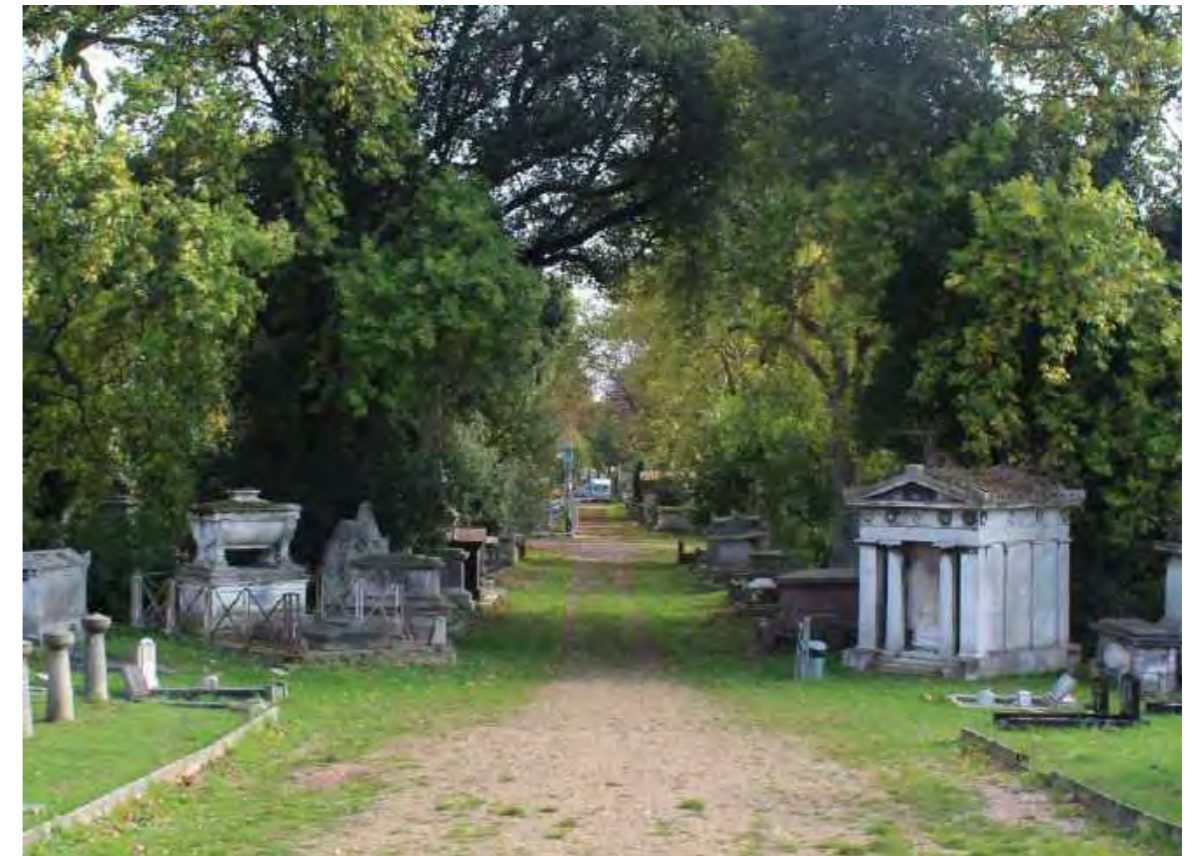
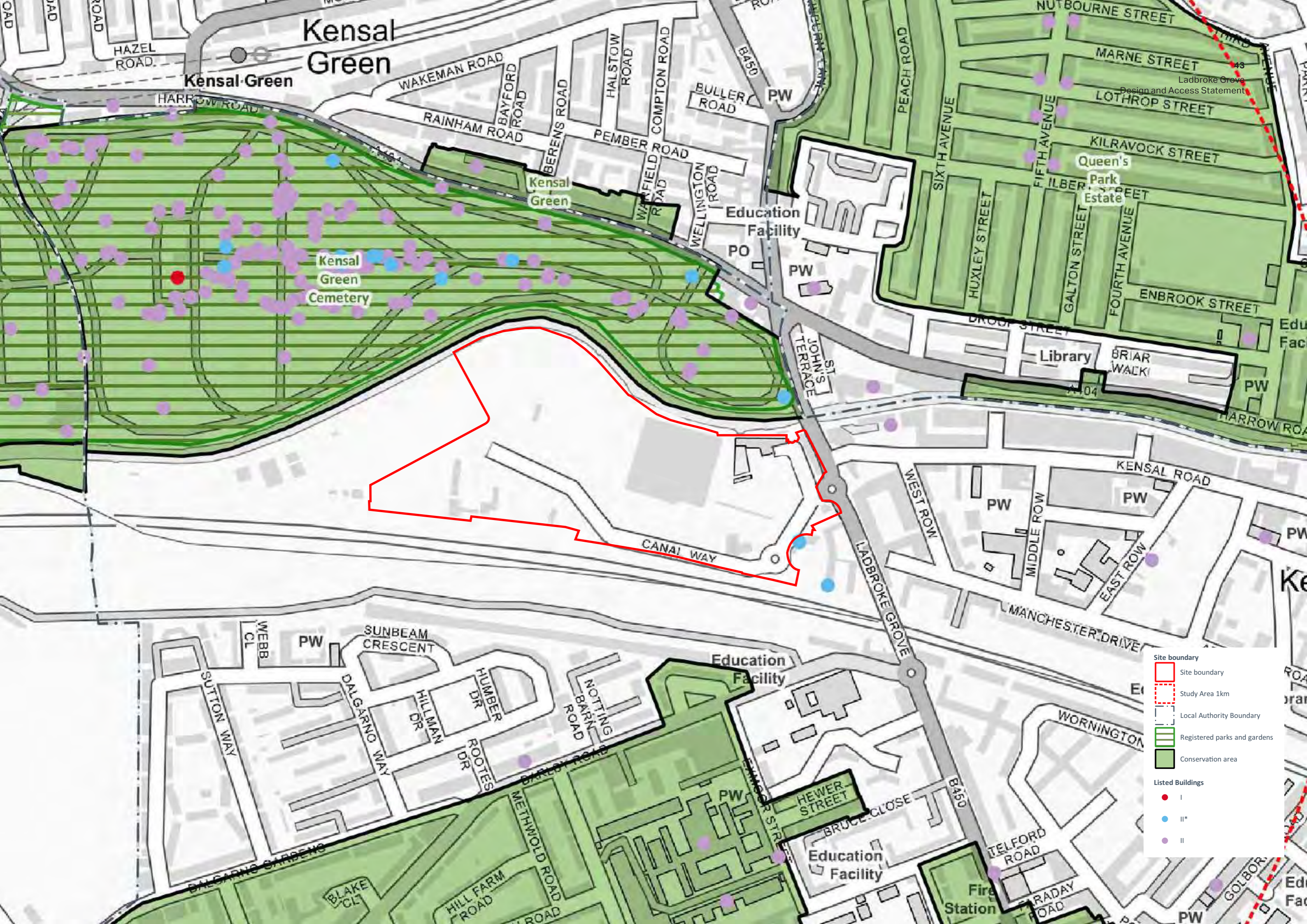

Fig 3.32: The central avenue looking east



Kensal Green

Kensal Green

Kensal Green Cemetery

Education Facility

Library

Education Facility

Education Facility

Fire Station

- Site boundary
- Study Area 1km
- Local Authority Boundary
- Registered parks and gardens
- Conservation area
- Listed Buildings
 - I
 - II*
 - II

3.1.5 Local Context

3.1.5.1 The Immediate Site context

The site has an unusual set of constraints given its proximity to central London. It is a large former utilities site connected to the rest of the locality at its eastern end where it meets Ladbroke Grove.

The Grand Union canal sits between the site and the Grade I listed landscape of Kensal Green Cemetery to the North. The Great Western mainline divides the site from the North Pole land to the south.

3.1.5.2 Kensal Canalside Opportunity Area

The Kensal Canalside Opportunity Area (KCOA) Supplementary Planning Document was adopted on 7th July 2021. The KCOA is described as follows:

Kensal Canalside is one of 48 Opportunity Areas within the London Plan, 2021 and the largest brown field site within the Royal Borough of Kensington and Chelsea. The Kensal Canalside Opportunity Area has been allocated to deliver a minimum of 3,500 new homes and 2000 new jobs. There is an opportunity to transform this area into a high-quality, well-connected, attractive and sustainable Canalside neighbourhood for people to live in, work in and visit.

3.1.5.3 Kensal Green Cemetery

Kensal Green Cemetery opened in 1833 and was the first commercial cemetery in London. The need for large cemeteries in London was stimulated by the increase in population and the inadequate space provided by existing cemeteries and churchyards, and Kensal went on to become one of London's 'Magnificent Seven' cemeteries.

The site includes two chapels with catacombs, an entrance gateway with lodges and a landscaped layout for monuments. Henry Edward Kendall (1776-1875) was the architect.



Fig 3.34: Local Context

The Friends of Kensal Green Cemetery was established on 13 June 1989 in order to raise the profile of the Cemetery as a place to visit and to organise regular guided tours.

The Friends led the restoration of the Dissenters' Chapel which was completed in May 1997. The Chapel has become the home of the Friends of Kensal Green Cemetery.

3.1.5.4 Kensal Town

Kensal Town (highlighted with the red dotted line adjacent) is a residential sub-district of Kensal Green in north-west London. It is located at the northern tip of the Royal Borough of Kensington and Chelsea where it meets the City of Westminster.

Often classified as North Kensington, it is included in the W postcode area and was first recorded in 1876 as Kensal New Town. This name had been used since the 1840s to distinguish the area south of the Harrow Road, in between the Grand Union Canal and the Great Western Main Line.

Prominent buildings in the area include the distinctive Trellick Tower, designed by architect Ernő Goldfinger, and Our Lady of the Holy Souls Roman Catholic Church on Bosworth Road. Both buildings are listed by Historic England.

3.1.5.5 Old Oak Common and Scrubs Lane

The Old Oak and Park Royal Development Corporation was established in 2015 to lead regeneration and planning work for an area covering Old Oak Common and much of the Park Royal area. The combined redevelopment area is envisaged to provide 65,000 new jobs and 25,000 new homes.

The engineering plans were revealed in 2018 showing a station at Old Oak Common for HS2, the high speed line running from London to Birmingham. Passengers using HS2 will be able to disembark at Old Oak Common and interchange with the Elizabeth line, Chiltern Railways and Great Western Railway services. The station will have a capacity for around 100 million passengers per year, rivalling London Waterloo in Central London.



Fig 3.35: A view towards the site from Kensal Road



Fig 3.37: A view towards the site from the Grand Union Canal



Fig 3.36: The Kensal Green Anglican Chapel



Fig 3.38: Future transport connections from Old Oak Common

3.1.6 The Opportunity Area, Site allocation and the SPD

The site forms part of the Greater London Authority's (GLAs) Kensal Canalside Opportunity Area designated within the London Plan (2021). The designation of the Opportunity Area means the Site is a strategic site for growth within London given the site's "significant development potential", targeting a minimum of 3,500 new homes and the creation of 2,000 new employment opportunities across the total 15.4ha designated area.

The Site also forms part of Policy CA1 (Kensal Canalside Opportunity Area) within RBKC's Local Plan which covers the Kensal Canalside Opportunity Area. Policy CA1 allocates development in the Opportunity Area to deliver a minimum of: 3,500 new residential (C3) units; 10,000sq.m of new offices; 2,000sq.m of new non-residential floorspace, including social and community and local shopping facilities in addition to the supermarket; a station on the Elizabeth Line; and the relocation and re-provision of the existing Sainsbury's supermarket.

The site's status as an Opportunity Area confirms unambiguous policy support for development on site at a scale commensurate with the proposals contained within this planning application.

To provide further guidance on what the Council expects to see within the proposed redevelopment of the Kensal Canalside Opportunity Area, RBKC have prepared the Kensal Canalside Opportunity Area Supplementary Planning Document (SPD). The SPD requires landowners to work collaboratively with the Council, local businesses and residents to bring forward comprehensive development of the Opportunity Area and is a material planning consideration in the assessment of any scheme within the Kensal Canalside Opportunity Area. The SPD reiterates the Site Allocation requirements from the adopted Local Plan, such as the provision of a minimum of 3,500 new homes, 2,000 sqm non-residential floorspace and 10,000 sqm of commercial space across the Opportunity Area.



Fig 3.39: The SPD opportunity area



Fig 3.40: Local plan Proposals Map (2019)



Fig 3.41: The SPD movement and connections diagram

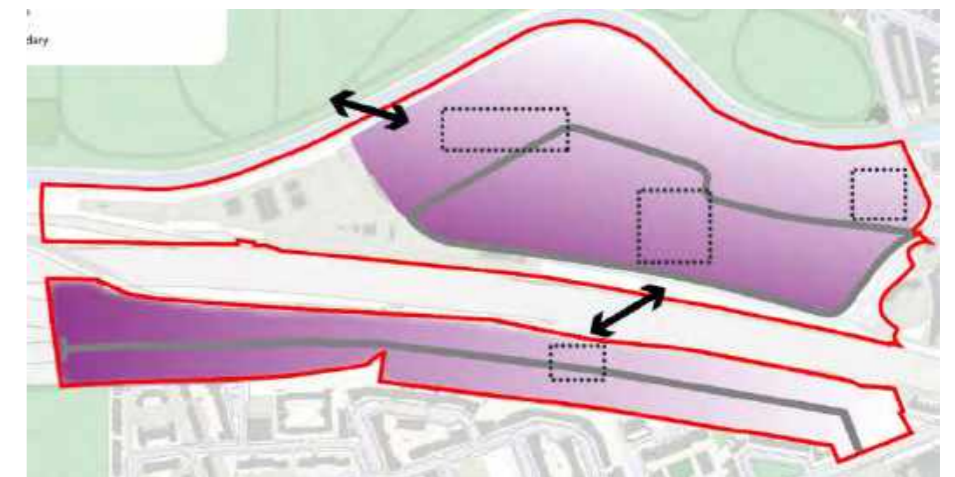

Fig 3.42: The SPD height and massing strategy diagram

3.1.7 Site Constraints

Existing infrastructure provides the greatest constraint to site development. The railway line to the south, access to the railway and no build zones, provide a significant single constraint to the development on site. Power and gas cables and lines and existing sewers also create a constraint with early re-connection required in order to facilitate space for building.

The site is close to two RBKC Conservations Areas, one to the south (Oxford Gardens Conservation area) and one to the north (the Kensal Green Cemetery Conservation area). The latter includes a number of significant listed monuments and 2 listed buildings – 1 of which, the Anglican Chapel, is Grade I listed.

To the east of the existing site is Kensal House, a Grade II* listed residential development and day nursery built to house the original workers of the gas works in the 1930's. The residents of this building, along with those of the water tower, are the closest residential neighbours alongside the 16 homes in the Boathouse Centre (which is within the Application Site).

Access to the railway track is required at all times and the Network Rail compound will need to be reprovided along the southern boundary before the site can be redeveloped.

There is a construction constraint to the existing retaining walls at the southern edge of the site that requires us to offset the new building line by 12m (marked 1. on the adjacent diagram)

The site contains a significant network of existing gas lines which run from the existing gas governor at the eastern edge of the site. These cross Plot 06 and run east - west across the site as indicated.

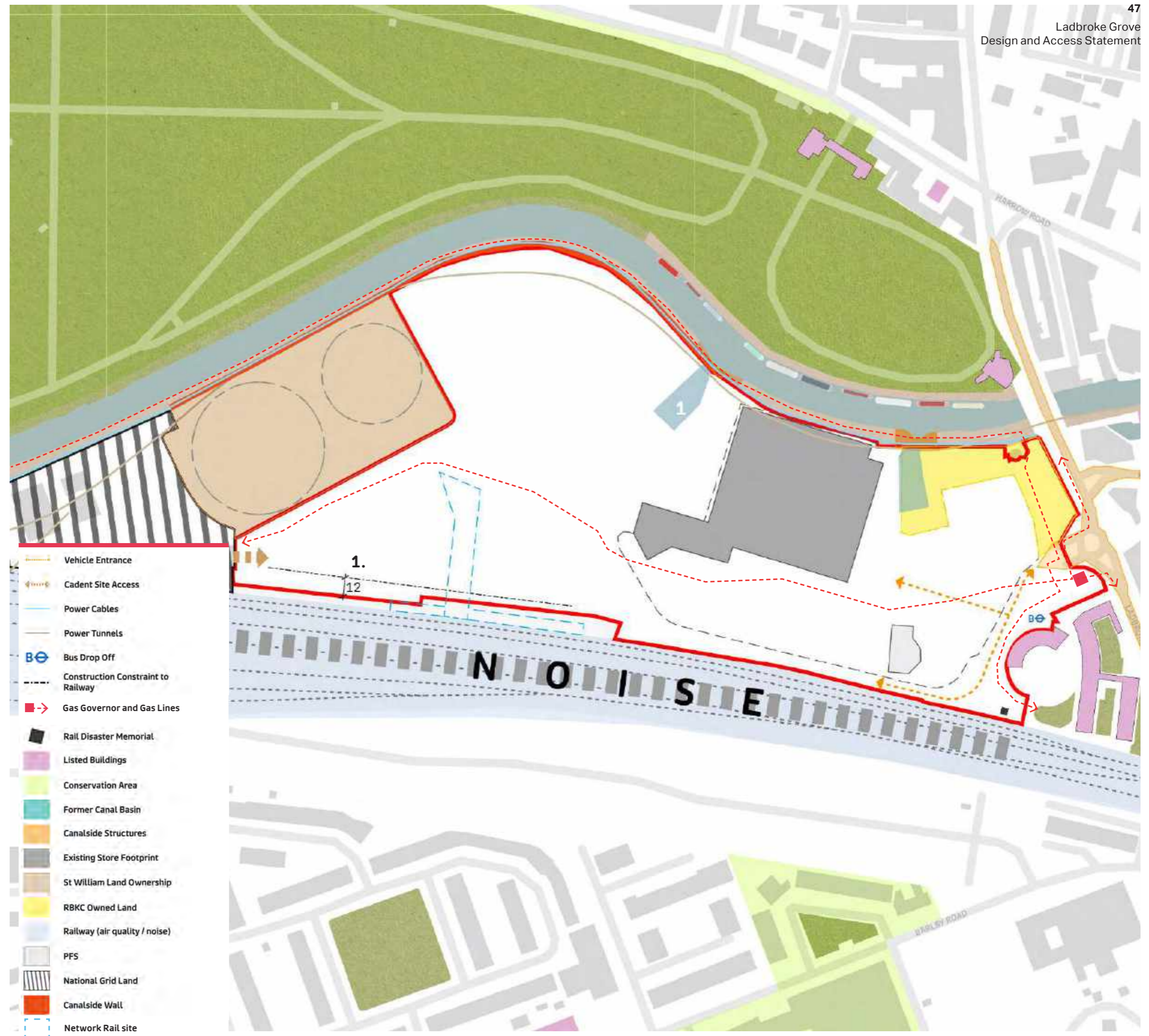

Fig 3.43: Local Context

3.1.8 Site Opportunities

There is a significant opportunity here to develop a former utilities site to provide new homes, workspaces and leisure destinations as well as a brand-new store for Sainsbury's. The site is unusual in London, undeveloped land divided from its surroundings by a canal to the north and a train track to the south, with one vehicle entrance at Ladbroke Grove.

The site would benefit from the delivery of bridges across the canal and the train track, connecting new residents of the site to the wider area and connecting the wider area to the centre of the site. We understand the emerging proposals by Berkeley St William include this bridge over the canal, a valuable link to the underground and train network. The southern bridge across the train tracks would connect the site to the south and the large green spaces at Wormwood and Little Wormwood, as well as nearby schools and health facilities. The bridge would also allow access to the site from residents from the south. In the long term with development of the North Pole site, this link also provides a western connection to Old Oak Common Crossrail / HS2.

The Grand Union Canal is a significant asset to the site and there are opportunities to connect, open up and improve the setting of the towpath and to reinstate the former basin used by the gas works. The canal is also an important ecological corridor and biodiversity gains may be made through careful landscape design.

Kensal Green cemetery offers an opportunity for the site to strengthen connections with the wider area and to benefit from a direct link to the cemetery's unique landscape. There are also important opportunities to improve the setting of Kensal House and the Rail Disaster memorial.

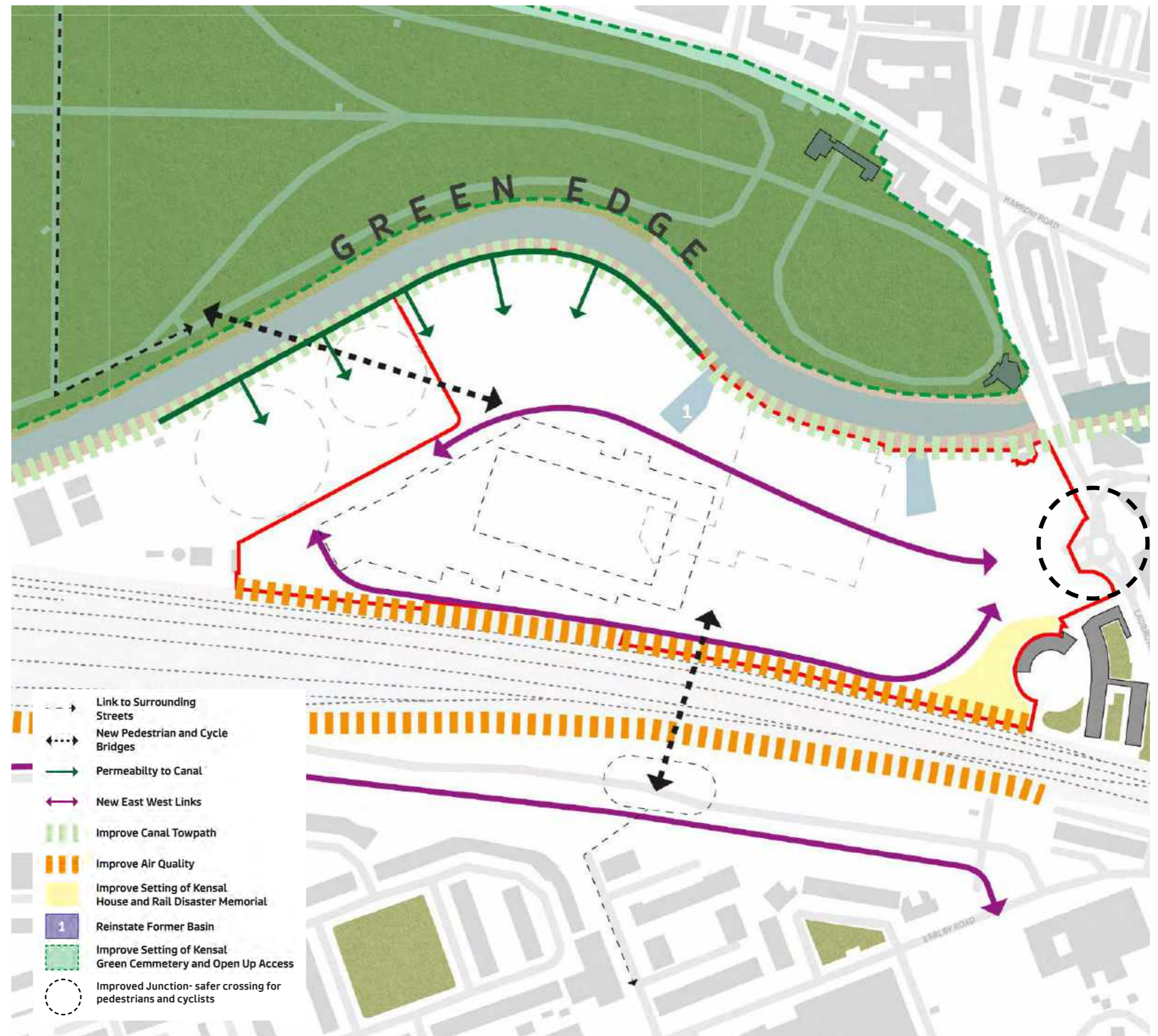

Fig 3.44: Local Context

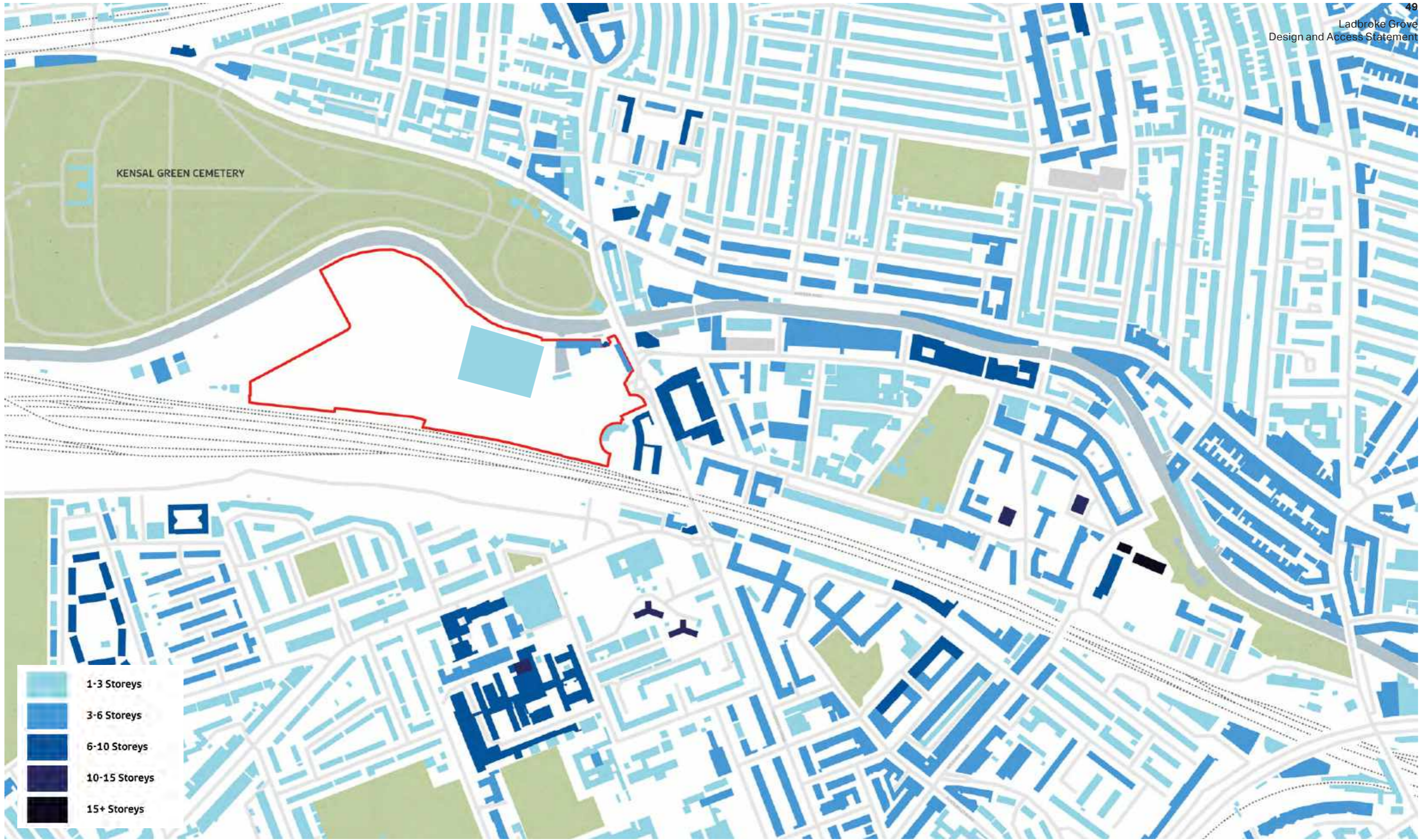

Fig 3.45: Building Heights

3.1.8.1 Building Heights

The diagram above describes the site and the approximate building heights of adjacent buildings.



Fig 3.46: Building Uses

3.1.8.2 Building Uses

The diagram above shows an approximate guide to the nearby buildings uses.

The diagram shows buildings that are predominantly residential in character but a number of local facilities nearby (including school and health centre immediately south), and an employment zone to the east

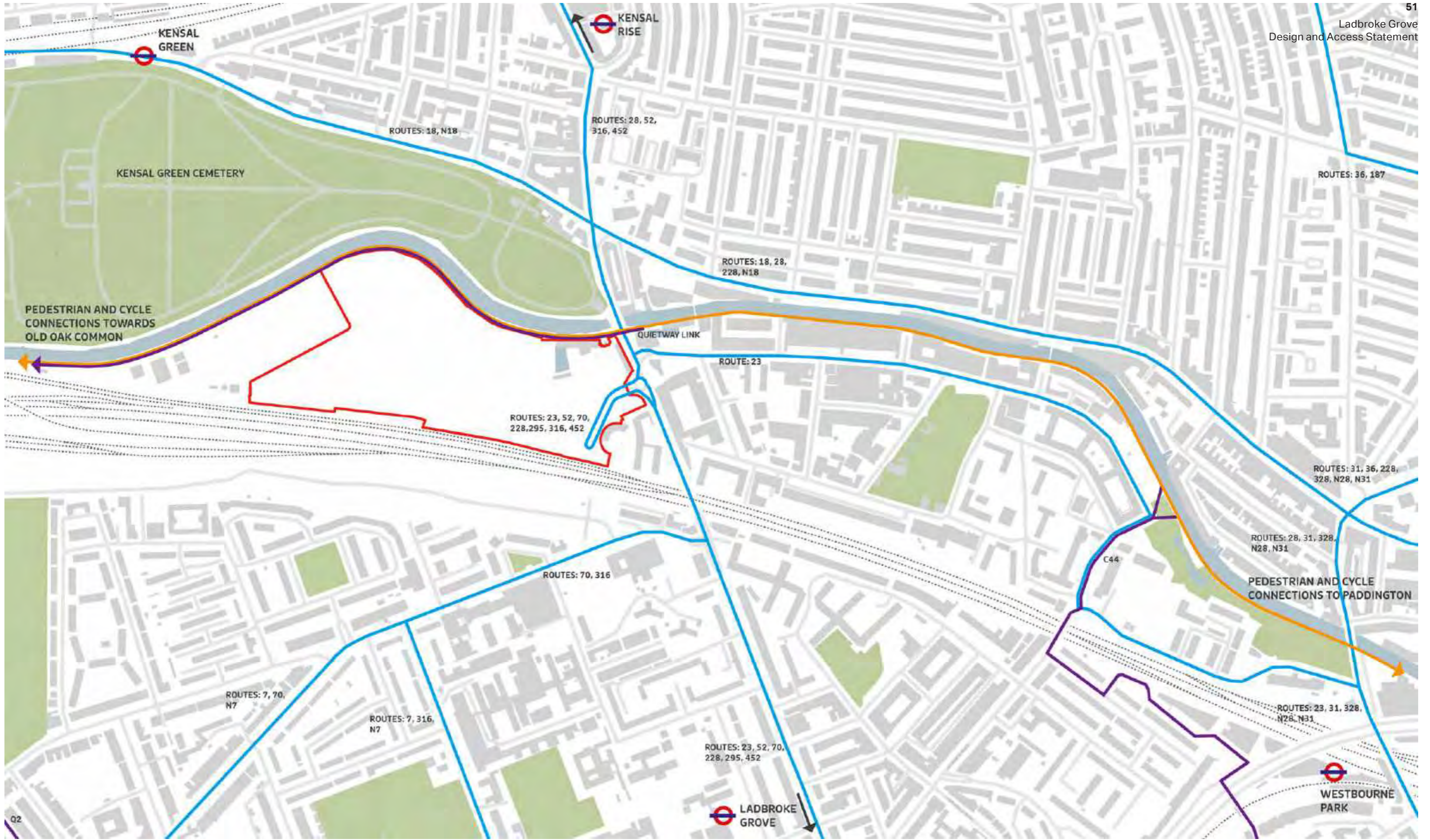

Fig 3.47: Building Heights

3.1.8.3 Connections

The site currently connects to 7 bus routes that run north and south on Ladbroke Grove and enter the site to collect and drop off passengers at the existing Sainsbury's Store.

Ladbroke Grove tube station is approximately 15 minutes walk to the south of the site, and Kensal Green 15 minutes walk to the north,

The canal towpath is well used by cyclists and pedestrians. The path is narrow and is poorly lit at night.

- Cycle Routes
- Bus Routes



Fig 3.48: Local open spaces

3.1.8.4 Open Space Network

The site is relatively well connected to a variety of local green spaces.

The provision of the southern railway bridge (A) and the western canal bridge (B) would improve access to open space.

3.2 Community Involvement

3.2.1 Community Consultation

Our community consultation team, CommComm, have been undertaking consultation with local residents and stakeholders since February 2021. The consultation builds upon some of the work done previously by RBKC as they developed the SPD. The consultation process is presented in detail with our teams Statement of Community Involvement.

3.2.1.1 Process

The consultation process has taken various forms and has adapted to react to the various requirements of the Covid regulations we have had to deal with during 2020 and 2021.

Letters, emails and flyers have been issued to local residents. Websites and online surveys have been made available and the built ID app went live in August 2021.

All the data has been collected by CommComm and presented back to the client and design team to assist with the evolving masterplan for the site.

3.2.1.2 Consultation Events

Virtual Q&A sessions have been held with local residents and members of the client group and design team.

Four public exhibitions have been held in 2021, each one held jointly with Berkeley St William and their design team.

The client group and design team attended Community Viewpoint Meetings and stakeholder workshops on specific themes such as landscape and transport connections.



Fig 3.49: Public exhibition - July 2021

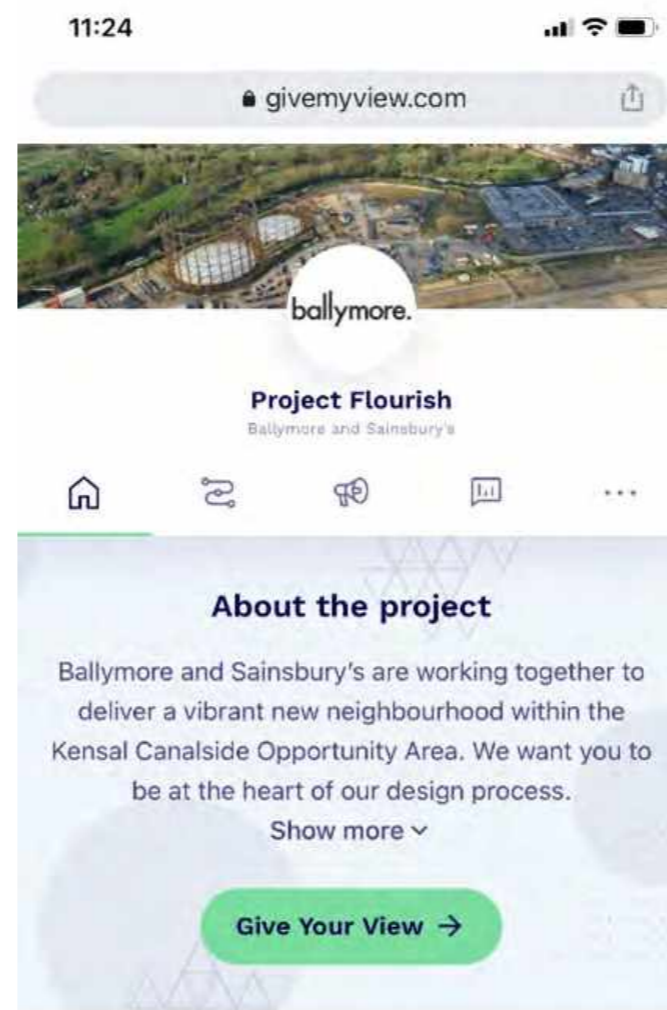

Timeline — Project Flourish Timeline

Fig 3.52: Give my view - Built ID



Fig 3.50: Stakeholder workshop - September 2021



Fig 3.51: Consultation model - September 2021

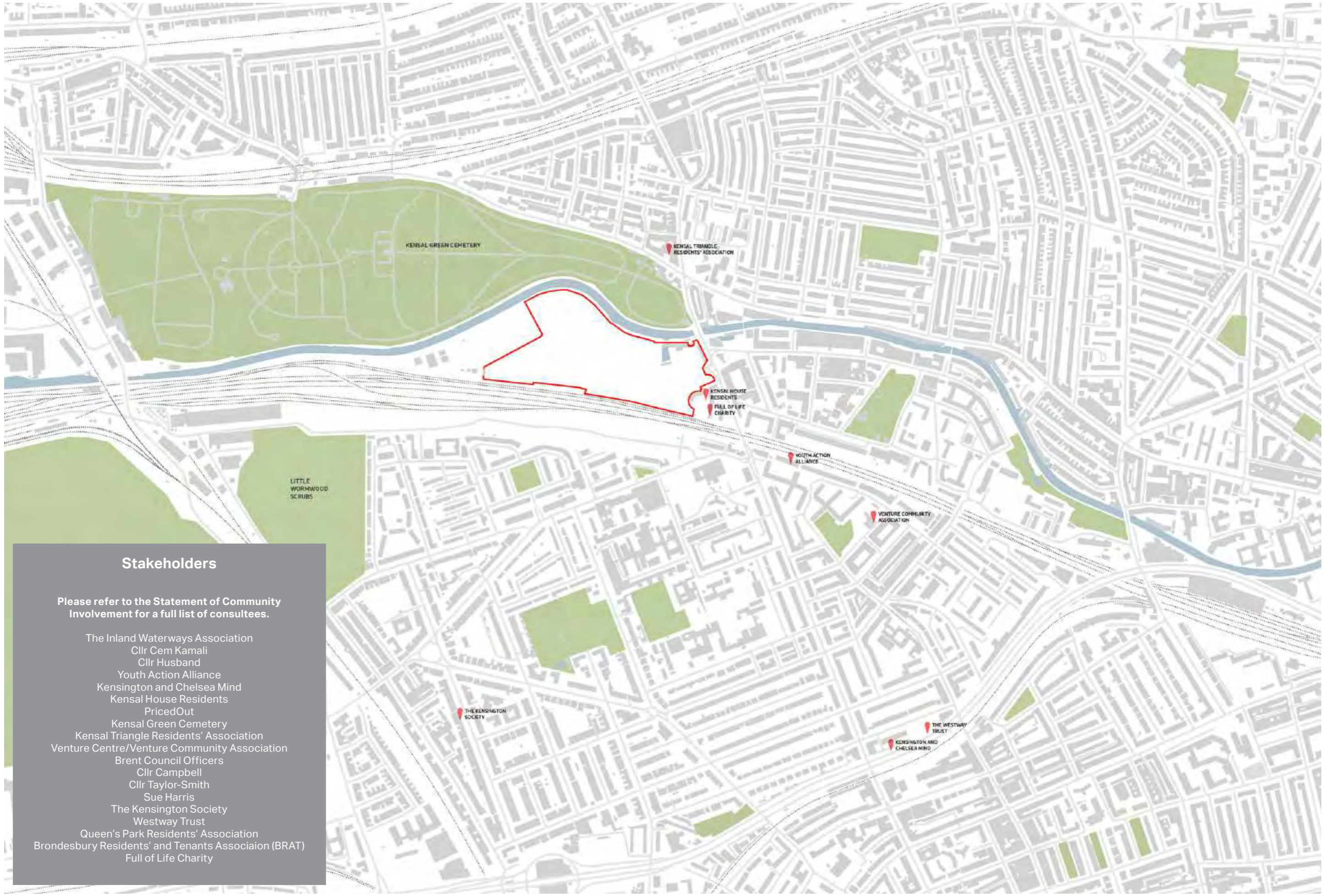

Stakeholders

Please refer to the Statement of Community Involvement for a full list of consultees.

- The Inland Waterways Association
- Cllr Cem Kamali
- Cllr Husband
- Youth Action Alliance
- Kensington and Chelsea Mind
- Kensal House Residents
- PricedOut
- Kensal Green Cemetery
- Kensal Triangle Residents' Association
- Venture Centre/Venture Community Association
- Brent Council Officers
- Cllr Campbell
- Cllr Taylor-Smith
- Sue Harris
- The Kensington Society
- Westway Trust
- Queen's Park Residents' Association
- Brondesbury Residents' and Tenants Association (BRAT)
- Full of Life Charity

This page is intentionally blank

3.3 Masterplan Structure

3.3.1 Introduction

This section of the report describes the masterplan vision, structure of the plan and the key character areas that underpin the vision.

3.3.1.1 The Masterplan Vision

The masterplan vision can be distilled to the following key points.

The redevelopment unlocks the opportunity to:

- Rejuvenate a former brownfield site into a unique location that connects with its surroundings.
- Facilitate new connections between the site and the surrounding areas in the form of new pedestrian and cycle friendly bridges.
- Create a new neighbourhood that meets the needs of a new population as well as the existing population of the local area.
- Rationalise the land currently used to house a Sainsbury's superstore and create space for much needed housing.
- Create a sequence of new public spaces that cater for residents and visitors and make positive connections to the local area.
- Celebrate the unique location and geography of the site and connect the cemetery and canal, the train track and Ladbroke Grove into a new place in North Kensington.



Fig 3.53: Concept sketch for the sites central high street



Fig 3.55: The Notting hill Carnival



Fig 3.57: Developing the first masterplan sketches.



Fig 3.54: An aerial view of the site c.1950



Fig 3.56: Mapping surrounding activity and cultural assets



Fig 3.58: Concept sketch



Fig 3.59: The Regents Canal in East London

3.3.2 Key Principle 01: Connections

Our masterplan includes the provision for bridge landing positions on Ballymore/Sainsbury's land to the North Pole site (Owned by the Department for Transport) and safeguards the route to the bridge on Berkeley St William owned land, which provides a connection to Kensal Green Cemetery in the west. The development team and landowners recognise that the delivery of the bridges would benefit the masterplan, ensuring future connectivity to and from the site, promote active travel between the site and nearby public transport links and improve the permeability of the area as a whole.

Whilst the bridges themselves do not form part of this planning application, (as far as we currently understand it, the canal bridge will form part of the Berkeley St William development) both landowners have consulted with specialist designers to inform potential strategies for implementation and are actively in discussions with neighbouring landowners to facilitate the bridge delivery.

At the western side of the site the cemetery bridge would connect from land owned by Berkeley St William to the cemetery. The applicants support the aspirations of RBKC to promote this connection which would provide site residents with a much shorter connection to Kensal Green station and with access to wider cemetery landscape.

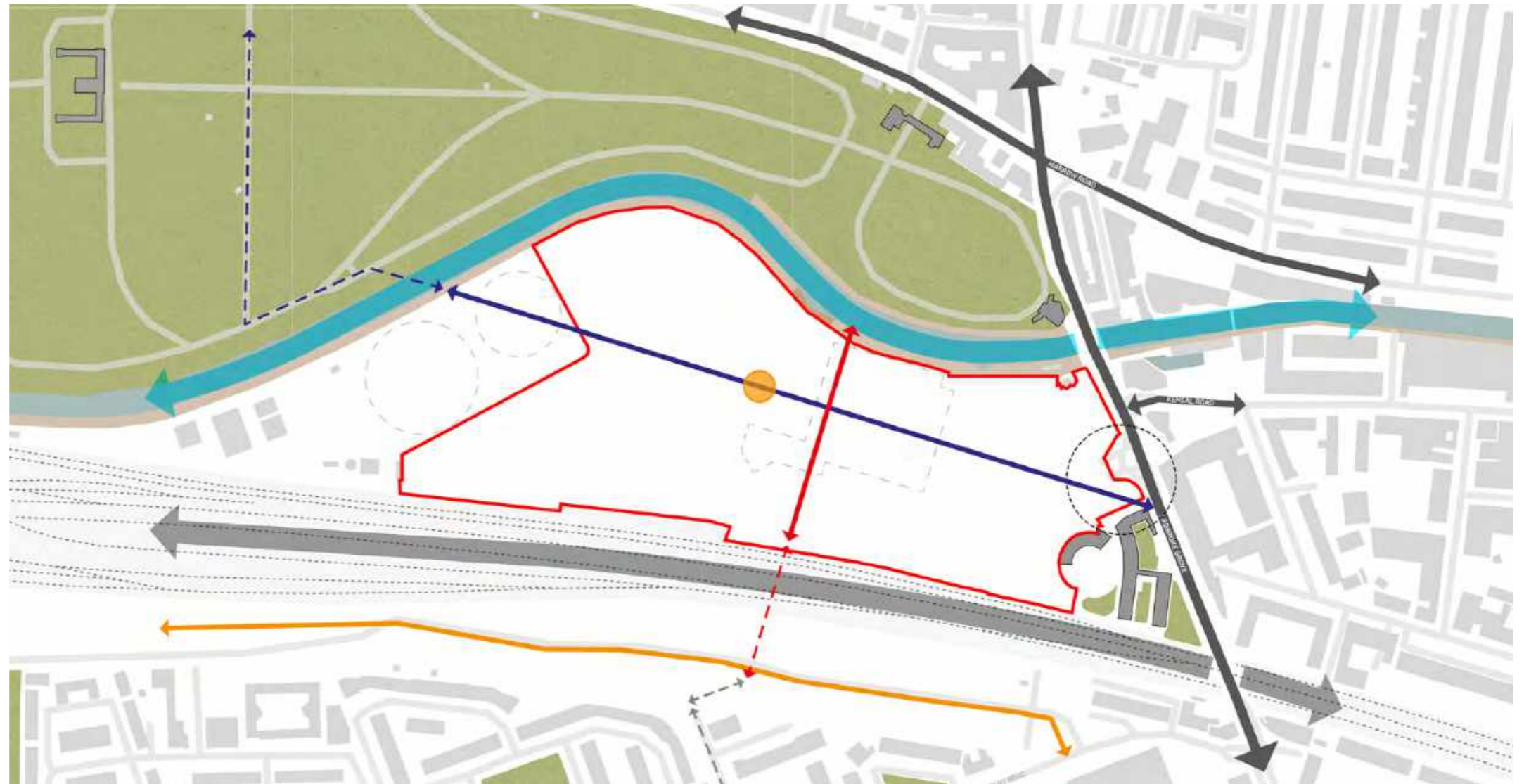

Fig 3.60: Diagram: Key Principles: Connections

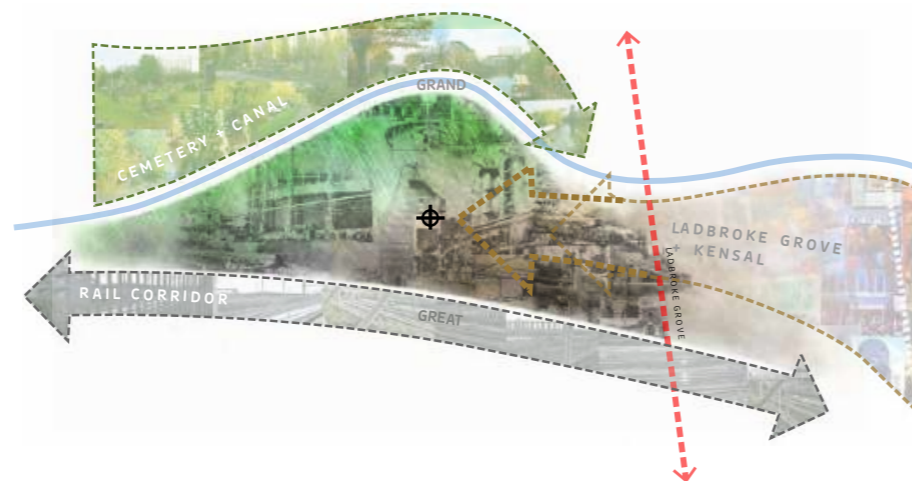

Fig 3.62: Concept diagram showing the connection of 3 varied site contexts



Fig 3.61: TFL WebCAT analysis: 15 Minute Bus Journey

3.3.2.1 Connections to the locality

With the exception of the Sainsbury’s store and the portion of RBKC land to the north east, the site as it stands today is an inhospitable place, a former industrial site shut off from the surrounding area and used variously for storage, service access and for access to the railway tracks.

The canal towpath and the Ladbroke Grove entrance to the east, provide the only access for pedestrians. A pleasant place to walk by day, but an intimidating route to use by night.

The masterplan design seeks to integrate this complicated site with its surroundings offering new connections, routes and facilities which invigorate the experience of visiting site.

The northern half of the opportunity area is predicted to provide a home for approximately 8,500 new residents on the Ballymore/Sainsbury site. The needs of these residents will be provided on site in terms of private and public amenity space, services, shops and leisure activities.

It is intended that this new neighbourhood centre compliments neighbouring areas, extended the existing pattern of active street frontages to the west of the site, Portobello and Golbourne Road, and Chamberlain Road to the north.

The new Sainsbury’s store is an important part of this new neighbourhood, anchoring the new high street and providing important footfall at all times of the day, movement that will support a variety of businesses and services on site.



Fig 3.63: Diagram: The wider context of Neighbourhood Centres

3.3.3 Key Principle 02: Character and Context

3.3.3.1 Character and Context

A key element of our masterplan relates to the way in which the site responds to the varied surrounding context. Conceived as a tripartite relationship, the site structure aims to balance the surrounding context and bring it together within the site, using the context to define spatial character, built form and public realm.

3.3.3.2 Tripartite context diagram

We have defined the three converging characters as follows.

Nurture: The influence of the cemetery, its mature trees, the canal and the water. Celebrating the heritage context and the canal and enhancing the influence of the natural setting at the canal edge.

Transact: The connection at the eastern edge of the site to the wider area. An opportunity to make a better connection across Ladbroke Grove.

Move/Make: The busy railway corridor. An opportunity to look south across London and to create a new landscape above the train tracks and a future connection to the North Pole site.

3.3.3.3 Kensal Town and the concept of 'the ile'

The site is unique in that it forms part of a wider 'island' within London, divided by the railway to the south and the canal to the north. Kensal Town has a character of its own, a rich history of creative industry, a mix of building uses and typologies, and quiet residential streets.

The KCOA site provides an opportunity to reconnect the two sides of this connected space to form a connected 'ile' space.



Fig 3.64: Key Principles: Character and Context

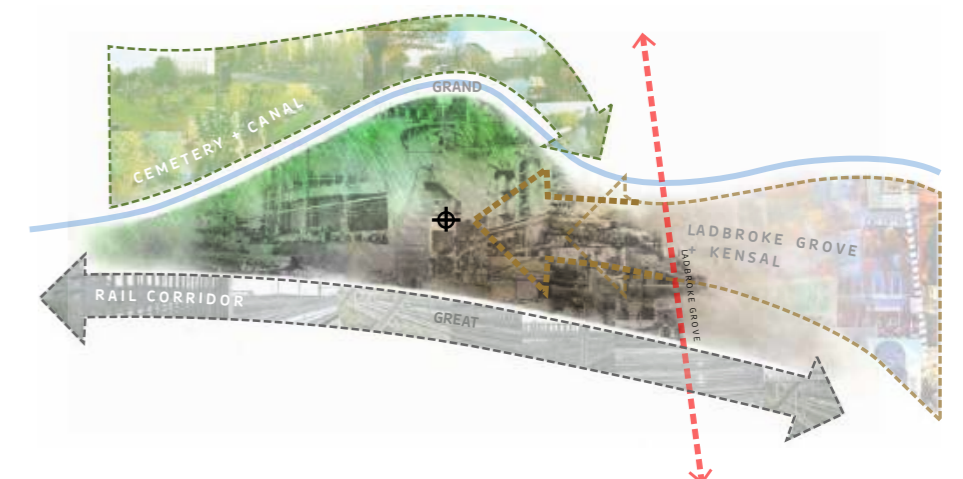

Fig 3.65: The Tripartite Concept Diagram

3.3.3.4 Transact: The eastern influence of Kensal Town

Where the masterplan meets Ladbroke Grove we envisage new connections to be made both in terms of movement in and out of the site and in terms of the types of uses that will be housed in this part of the site.

A new road junction is proposed at the entrance of the site, designed to better manage movement of vehicles, pedestrians and cyclists through this part of the Ladbroke Grove and connect them into the site.

A significant part of the connection at this part of the site is linked to the way the masterplan addresses the canal edge. There is a great opportunity to provide a much more permeable edge to this part of the site, providing better pedestrian and cycle links. There is also an opportunity to link the development along the canal edge with the Portobello Dock on the eastern side of Ladbroke Grove.

Ground floor active uses which provide workspace, evening and weekend leisure services and retail space would be suitable uses for the ground level of the proposed buildings. These uses will activate both the entrance to the site and the canal edge, which currently is not very welcoming after dark.

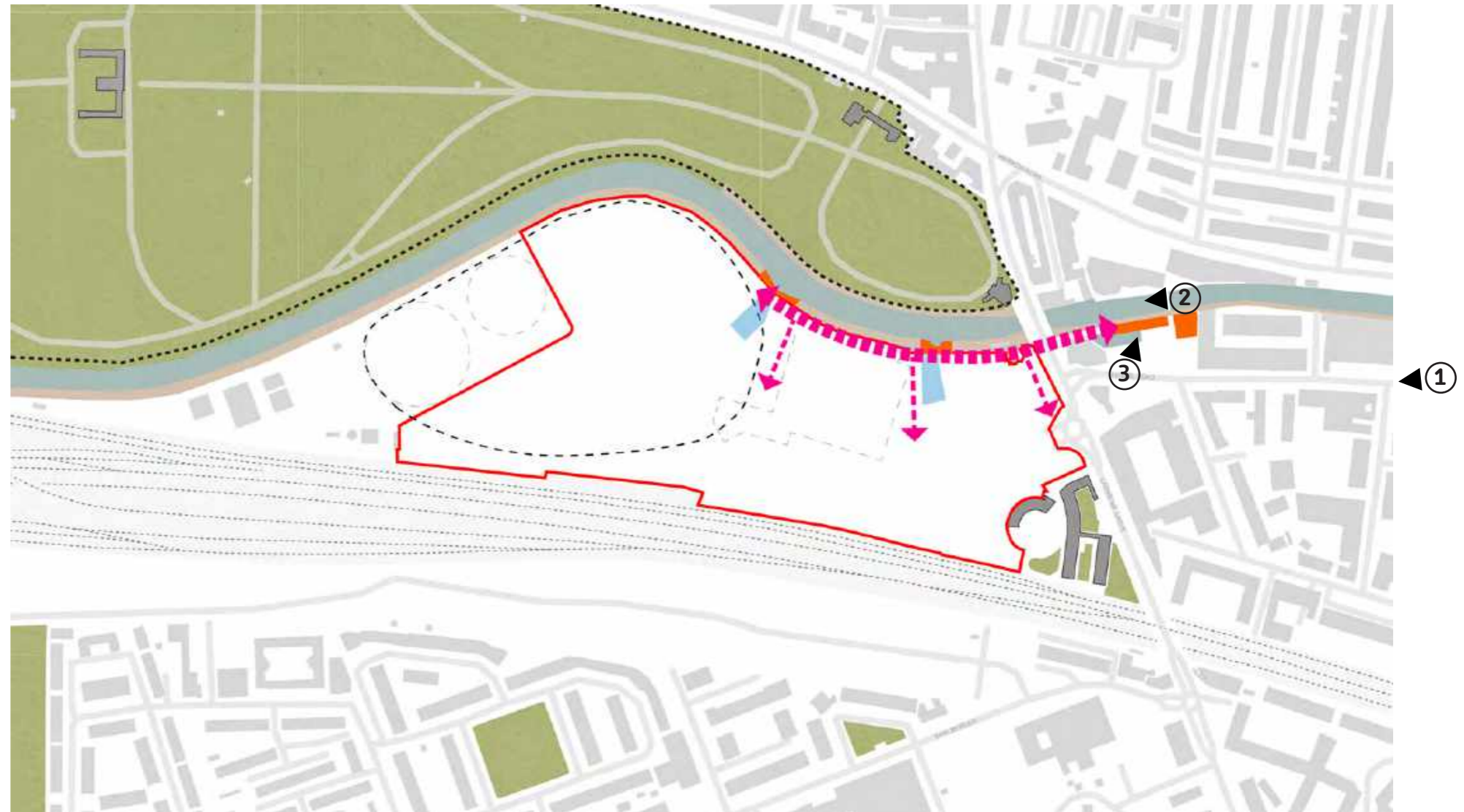

Fig 3.66: The eastern canal edge



Fig 3.67: A view westward from Kensal Road

①



Fig 3.68: A view westward along the canal

②



Fig 3.69: The Portobello dock

③

3.3.3.5 'Nurture' The Cemetery and the Canal

On the western side of the canal bridge to the former gas works basin, the site becomes much greener and peaceful, with mature trees on both sides of the canal and a more peaceful atmosphere as you move further from the nearest road.

The masterplan proposes to locate the residential neighbourhood to this side of the site setting new homes within public and private gardens and connecting them wherever possible with views towards the water and the trees.

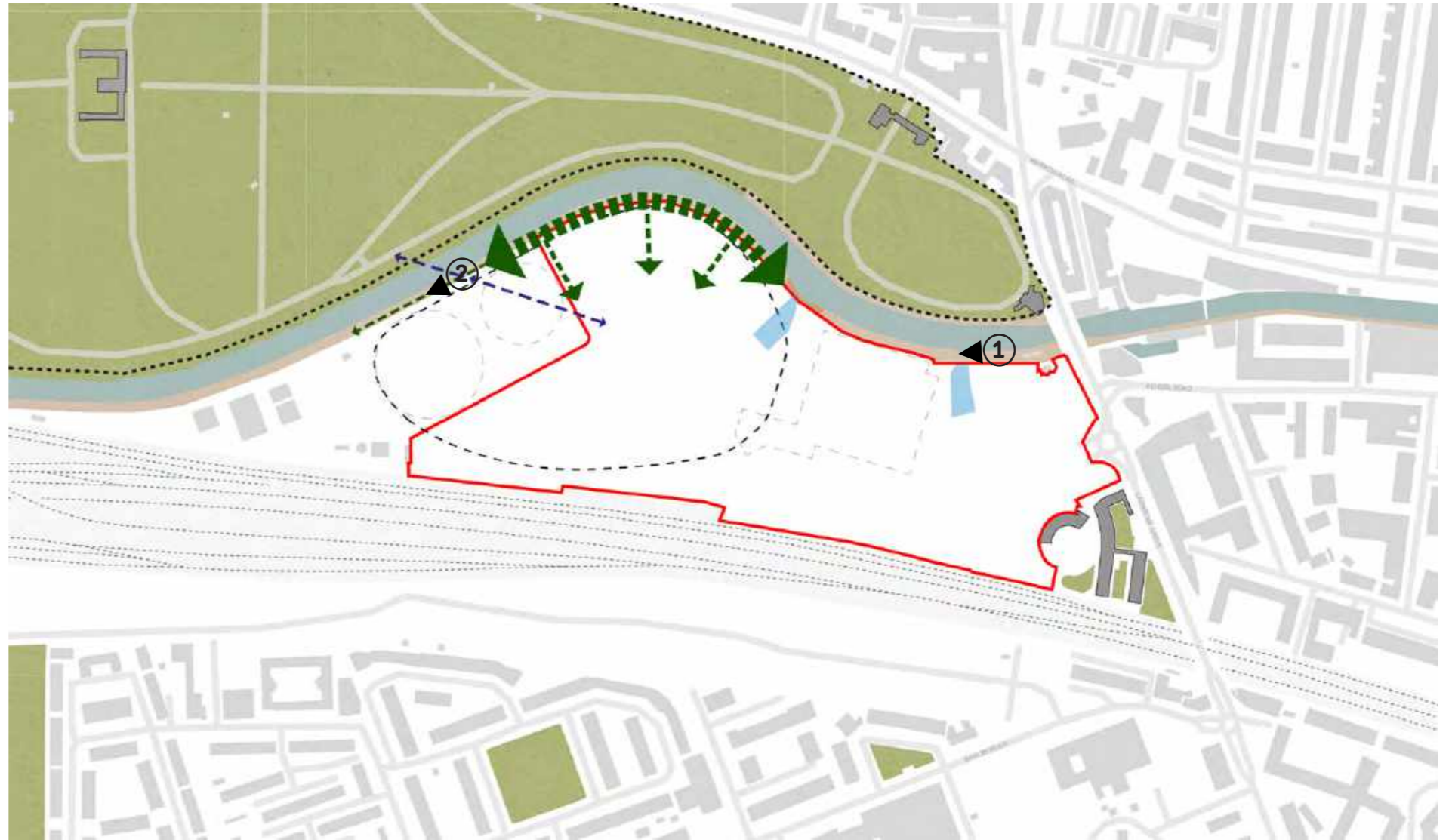

Fig 3.70: The western canal towpath



Fig 3.71: A view westward along the canal towards the former gasholders (now demolished)

①



Fig 3.72: A view westward along the canal taken from the far western edge of the site

②

3.3.3.6 'Make/Move' The Railway Corridor

Whilst in many ways the most challenging of the three contexts given the proximity of the railway, the broad south edge of the site is raised up above the tracks by around 6m and enjoys long views southward across London.

Currently this part of the site is used for the access road 'Canal Way' and for the private access route to the Network Rail access and the Cadent site to the far South West.

The masterplan safeguards a future bridge connection from the south and intends to use that connection to link the southern edge of the site to Ladbroke Grove via a landscaped route that provides a biodiversity corridor along the railway track.

This part of the site must also incorporate key development constraints. A 12m construction offset to the trackside retaining wall, maintaining access to the tracks for network rail, and providing access to the rear of the store for both deliveries and customers arriving by car has been proposed.

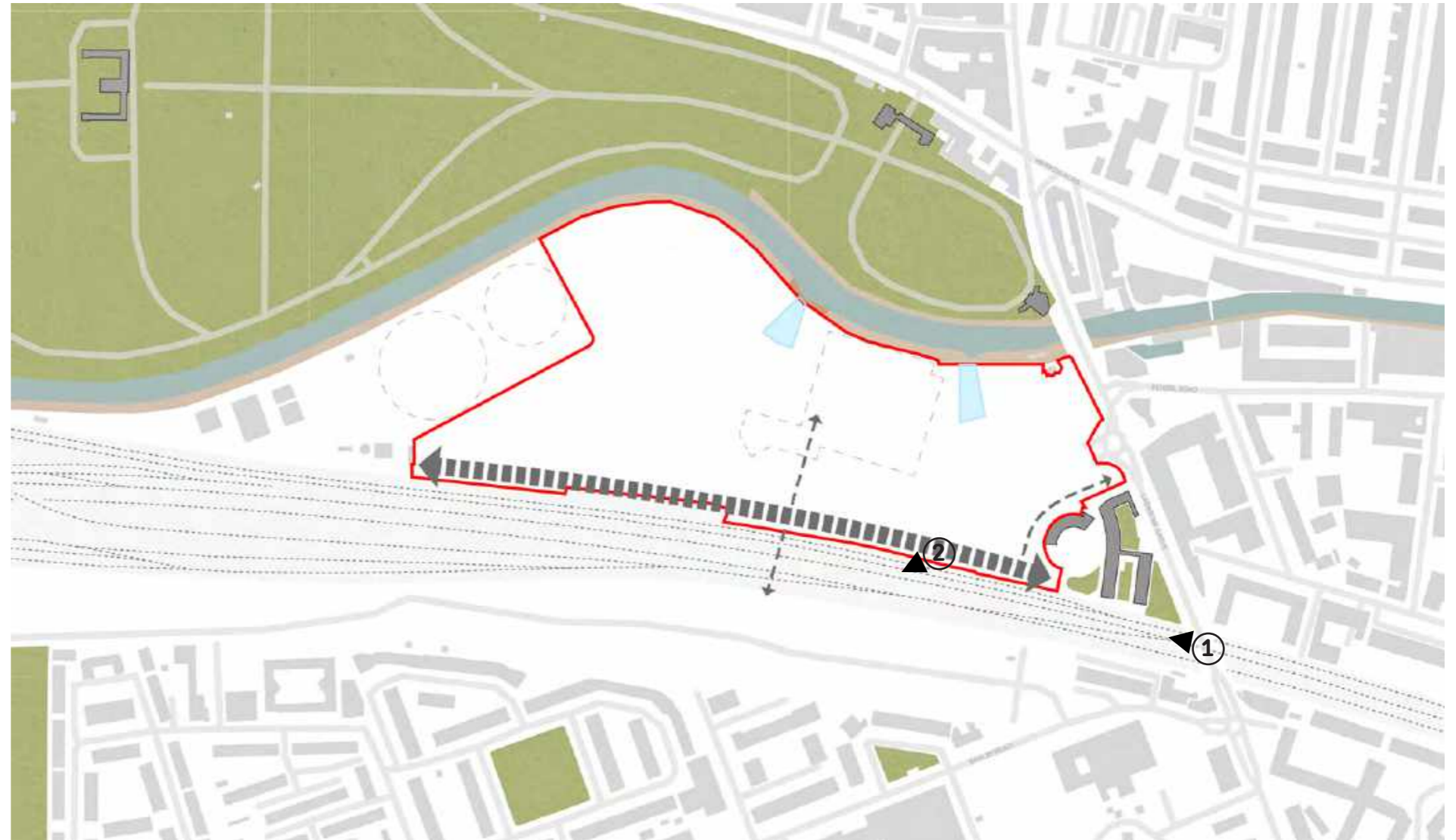

Fig 3.73: The southern edge of the site



Fig 3.74: The Great Western mainline

①



Fig 3.75: A view across the tracks towards the North Pole site

②

3.3.4 Key Principle 03: Locating the Store

One of the key parameters that the masterplan has been designed to incorporate is the relocation of the store and the requirement to maintain the existing store in operation during the first construction phase. As a result of this parameter we have positioned the store to the west of the existing store moving the pedestrian entrance of the store approximately 150m westward.

The new entrance of the store is positioned at the head of the new avenue, and is a key focal point for movement into and from this part of the site. With approximately 40,000 transactions each week, the movement to and from the store is a positive element for the site and helps to activate and maintain other businesses and facilities within the neighbourhood centre.

Due to the internal planning of the store and the relationship between the sales footprint, the delivery bay, the customer parking and the back of house service spaces, this leads us to need to bring vehicles down to the south side of the site to access these elements.

3.3.4.1 The existing store

Completed in March 1988, the existing purpose-built store is located on the eastern end of the site. The single storey building is fronted by a large surface level car park, providing nearly 400 parking spaces, as well as an 8-pump petrol filling station. The site is dominated by vehicular access. A roundabout on Ladbroke Grove provides access to the store car park, filling station and access to the rear of the site along the southern boundary. The proposed location of the new store enables the construction works to be phased in order to provide continuity of trading from the existing store to the new store. Whilst the sales area of the proposed store is larger than the existing, the number of parking spaces is reduced and the petrol filling station is not re provided. The new store with basement parking and service yard is integrated into the mixed use development, halving the land take of the existing store.

3.3.4.2 Positioning the new store

The adjacent drawing describes the key constraints that define the position of the new store. The padlocks in the diagram highlight the restriction created by those constraints, with only the northern side of the store having any flexibility for extension.

Point 'a' relates to the construction constraint offset defined by the retaining wall to the train tracks. In this location we are advised that we are unable to dig foundations within 12m of the retaining walls.

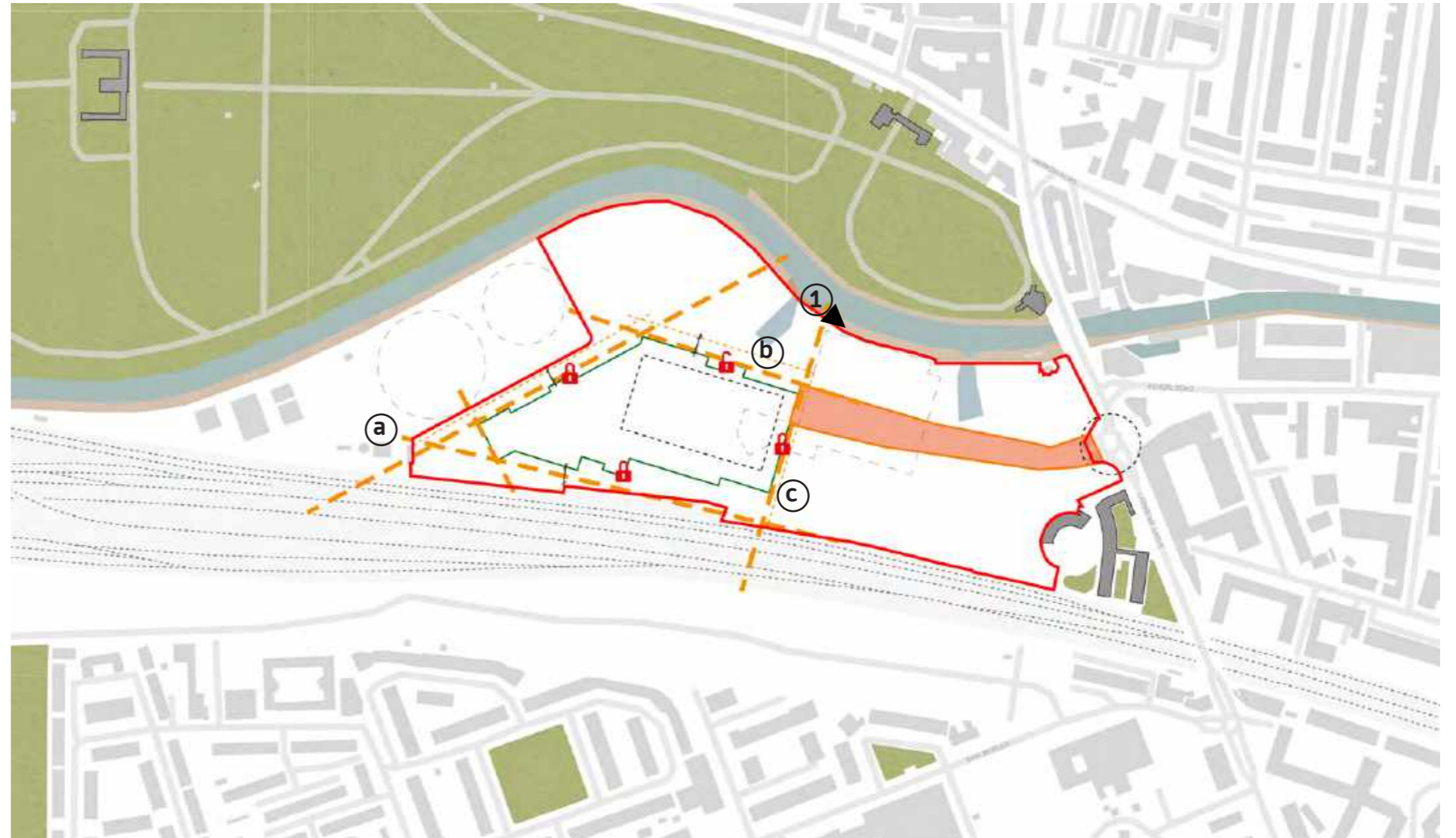

Fig 3.77: Locating the store

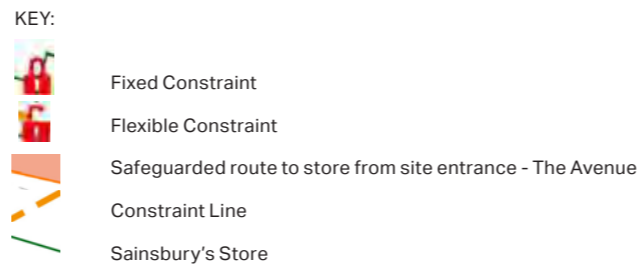

Fig 3.76: Point 1: The existing store, shortly after opening in 1988.

The location of the northern edge of the store at Point 'b' is defined by the proportion of the store footprint and the relationship between the site and the store entrance. The masterplan defines that the store entrance should be located at the head of the high street (Point 2).





Point 'c' is a phasing constraint and is defined by the western side of the existing store (shown dashed). The existing store must stay in operation throughout the construction period, the new store must therefore be built in the space behind the existing store.

A number of design options were considered during the design development on site. A review of these options is included in the 'Process' chapter of this report.



Fig 3.78: The relationship between the store and the high street known as The Avenue

KEY:

-  Safeguarded route to store from site entrance - The Avenue
-  Existing Sainsbury's Store
-  Proposed Sainsbury's Store
-  Potential future connections to masterplan and Store



3 Fig 3.79: Sainsbury's Car park



Fig 3.80: A concept diagram describing the eastern neighbourhood centre.

3.3.5 Key Principle 04: Activation

The eastern portion of the masterplan that connects to Ladbroke Grove is seen as a new neighbourhood centre capable of supporting the new population of residents on the site and offering a new set of services for those living close to the site. We see this part of the masterplan as supporting a range of ground floor uses, including doctors, dentists, shops, restaurants, business and workshops.

3.3.5.1 The neighbourhood centre

The neighbourhood centre is focused on the 'The Avenue' which connects Ladbroke Grove to the entrance of the Sainsbury's store and is the high street of the masterplan.

To the northern side of the Avenue we propose leisure and retail uses around the new wharf and the ground floors of the buildings in Plot 05. To the southern side of the high street we propose flexible work space, workshop and maker spaces, services (dentists, doctors) and space for a crèche. We suggest the above uses but acknowledge that there is flexibility within the parameters for future alternative uses.

3.3.5.2 Active Ground floor uses

The eastern side of the masterplan is submitted as an outline application and as such the uses we describe are indicative and will be defined at the detail stage of a reserved matters application (s).

The design is flexible however to accommodate a wide range of uses and to allow for future development of the strategy for active uses on site.



Fig 3.81: Ground floor activation fronting The Avenue

3.3.5.3 Future connections

The adjacent diagram places the development of the KCOA site in context with the development to the west at Old Oak Common. The Old Oak and Park Royal Opportunity Area Planning Framework (OAPF) describes up to 25,000 homes, 65,000 jobs a Cross rail station and a connection to HS2. The emerging plans suggest a bus route through the north pole site to the new transport hub at Old Oak Common.

Whilst the time frame for the development is not clear, should the development go ahead connections westward from the canalside site will become an important focal point for future inhabitants of the site.

The canal path will form an important link for both cyclists and pedestrians. Bridge links to the south, and to the west via the cemetery, will also provide important westward connections.

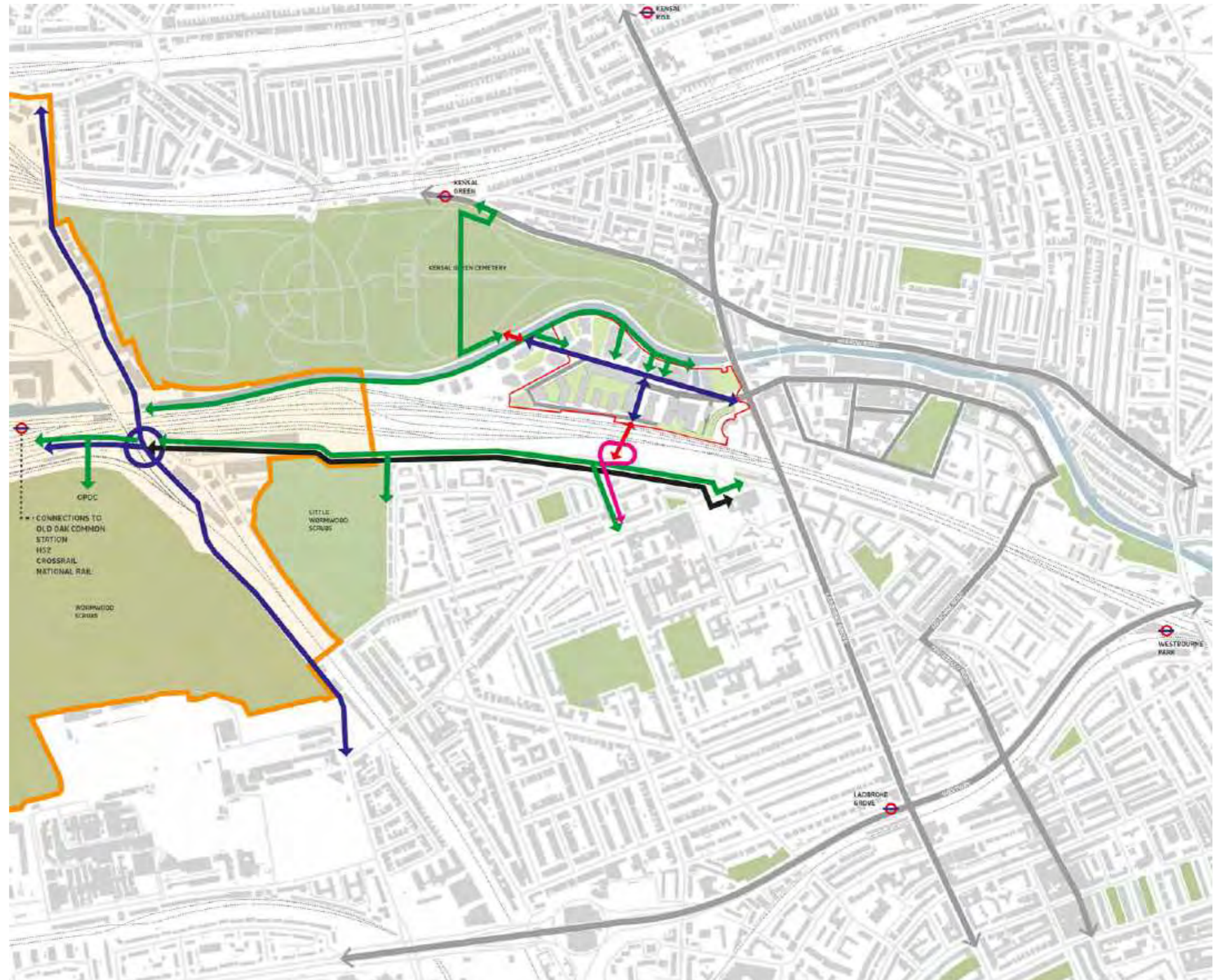

3.3.5.4 Connections to local amenities

The adjacent diagram describes existing connections to local schools and medical facilities.

Based on the analysis carried out by Volterra (refer to the Socio Economic Chapter of the ES documents) the proposed development does not generate a sufficient enough increase in population to require the provision of a new school.

The proposals include the potential to deliver a medical facility (e.g. dentist) if there is sufficient demand. Financial contributions will likely be required to upgrade existing GP facilities off site.

Existing links to local schools and medical facilities will be maintained via the Ladbrooke Grove entrance. A southern bridge link (if provided) would further improve the links to the south of the site, Barlby Primary School and St Charles Health Centre.





3.3.6 Key Principle 05: Open Space

The masterplan is made up of a network of open spaces connected by the key character areas. The intention is to provide spaces on site for a wide variety of activities and a wide variety of users.

The intention is to create a climate conscious, landscape-led masterplan that provides a year round symbol of sustainability for the borough, links both its industrial past and current context. The placement of gardens within the residential areas of the masterplan, the plan celebrates Kensington's acclaimed garden heritage for the new community.

3.3.6.1 Proposed open space

Each plot within the masterplan is provided with a key public realm feature which compliments its use and position within the masterplan.

The features of each space are explained in great detail within the landscape and public realm strategy document.

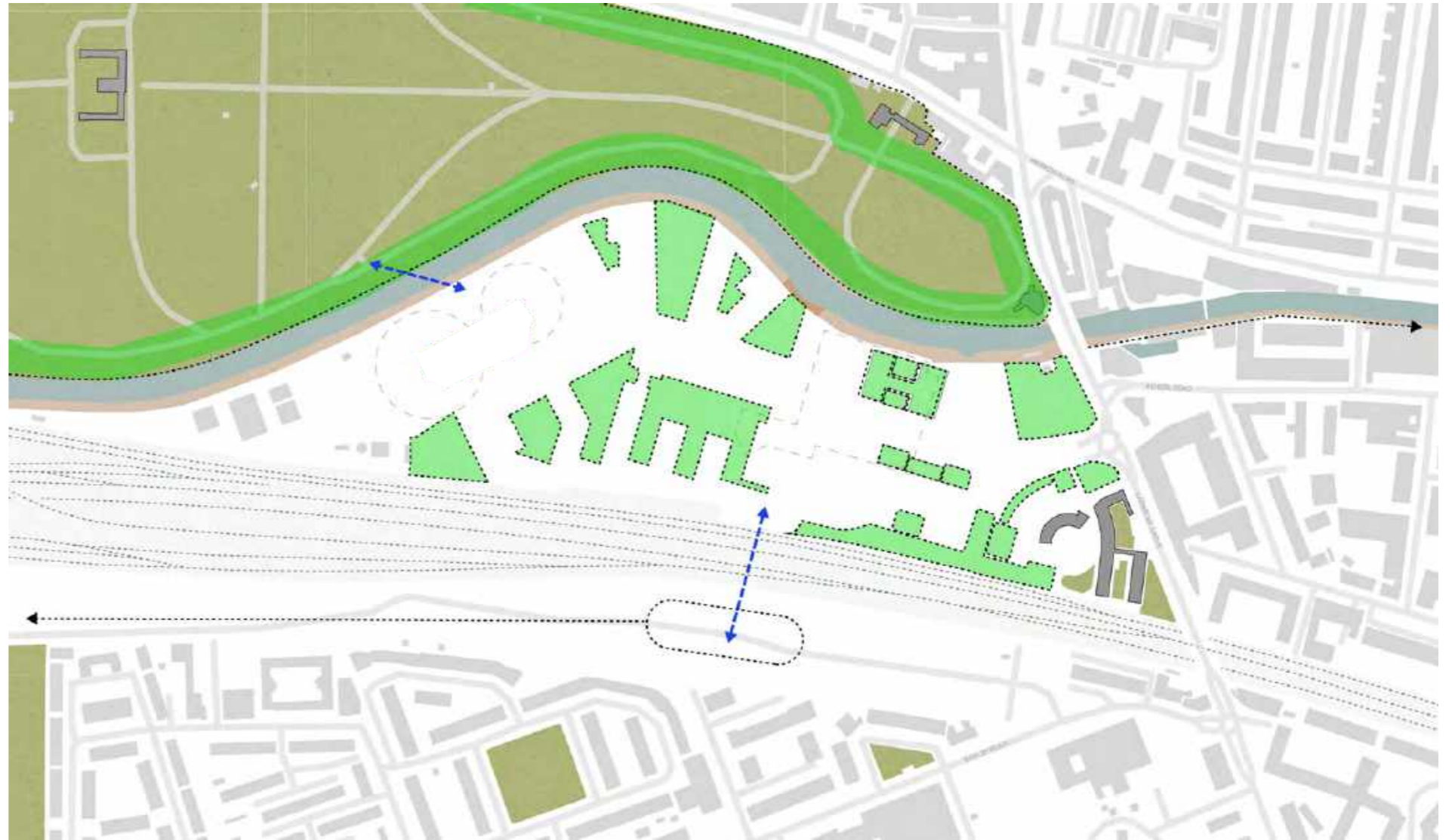

Fig 3.82: Open space diagram



Fig 3.83: Plot 04 garden

3.3.7 Key Principle 06: Block Structure

The masterplan structure, ownership characteristics and infrastructure requirements combine to divide the site into 5 development plots.

3.3.7.1 Development Plots

Plots 1, 5 and 6 shown in orange on the adjacent diagram form a connected neighbourhood centre, connected via the proposed high street and divided to the north and south by the canal and the train tracks.

Plots 2 and 4 shown in green, form the quieter residential half of the masterplan. The Sainsbury's store sits below the housing which is centred around a public south facing garden.

Plots 1,2 (residential components) 4, 5 and 6 will be submitted in outline within this application.

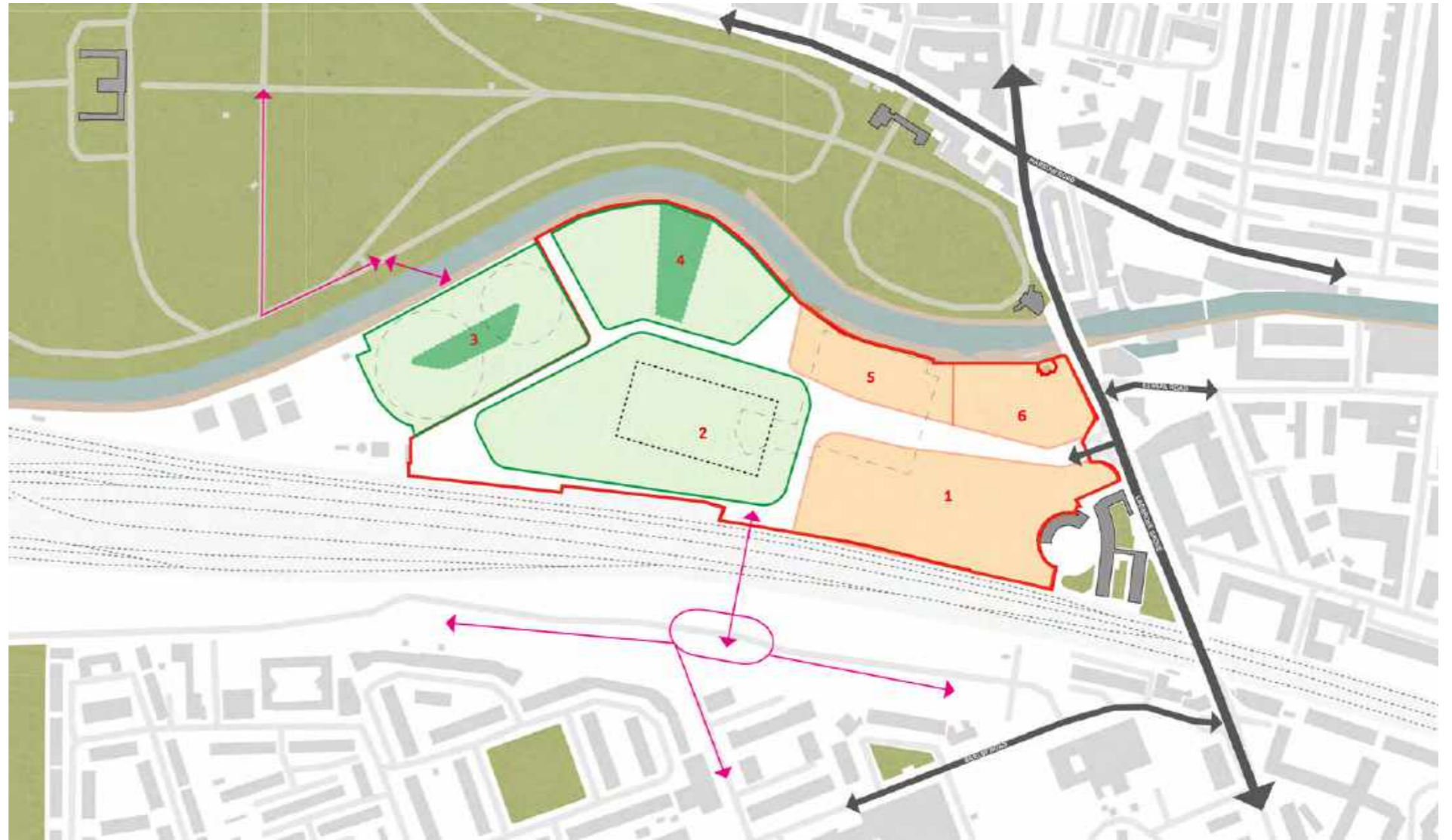

Fig 3.84: Block Structure diagram

This page is intentionally blank

3.4 Masterplan Design

3.4.1 Summary

3.4.1.1 The opportunity

The redevelopment unlocks the opportunity to:

- Rejuvenate a former utilities site into a unique location that connects with its surroundings.
- Facilitate new connections between the site and the surrounding areas in the form of new pedestrian and cycle friendly bridges.
- Create a new neighbourhood that meets the needs of a new population as well as the existing population of the local area.
- Rationalise the land currently used to house a Sainsbury's superstore and create space for much needed housing.
- Create a sequence of new public spaces that cater for residents and visitors and make positive connections to the local area.
- Celebrate the unique location and geography of the site and connect the cemetery and canal, the train track and Ladbroke Grove into a new place in North Kensington.

3.4.1.2 Our guiding principles

To help us realise our vision and bring Project Flourish to life we have developed our proposals around the following guiding principles:

1. Connect harmoniously with the existing character of the surrounding context to create a development that is an authentic response to a rich and varied context.
2. Respond generously to the context improving connections for new residents and for residents and visitors from the surrounding area.
3. Shape a development strategy that will have a positive impact for the site both in the short and long term.
4. Create a masterplan that allows people to flourish with access to a rich mix of uses and opportunities and as such create a sustainable place for years to come.
5. Adopt sustainable principles for design through all our endeavours, from urban design, through to the building fabric of the completed project.

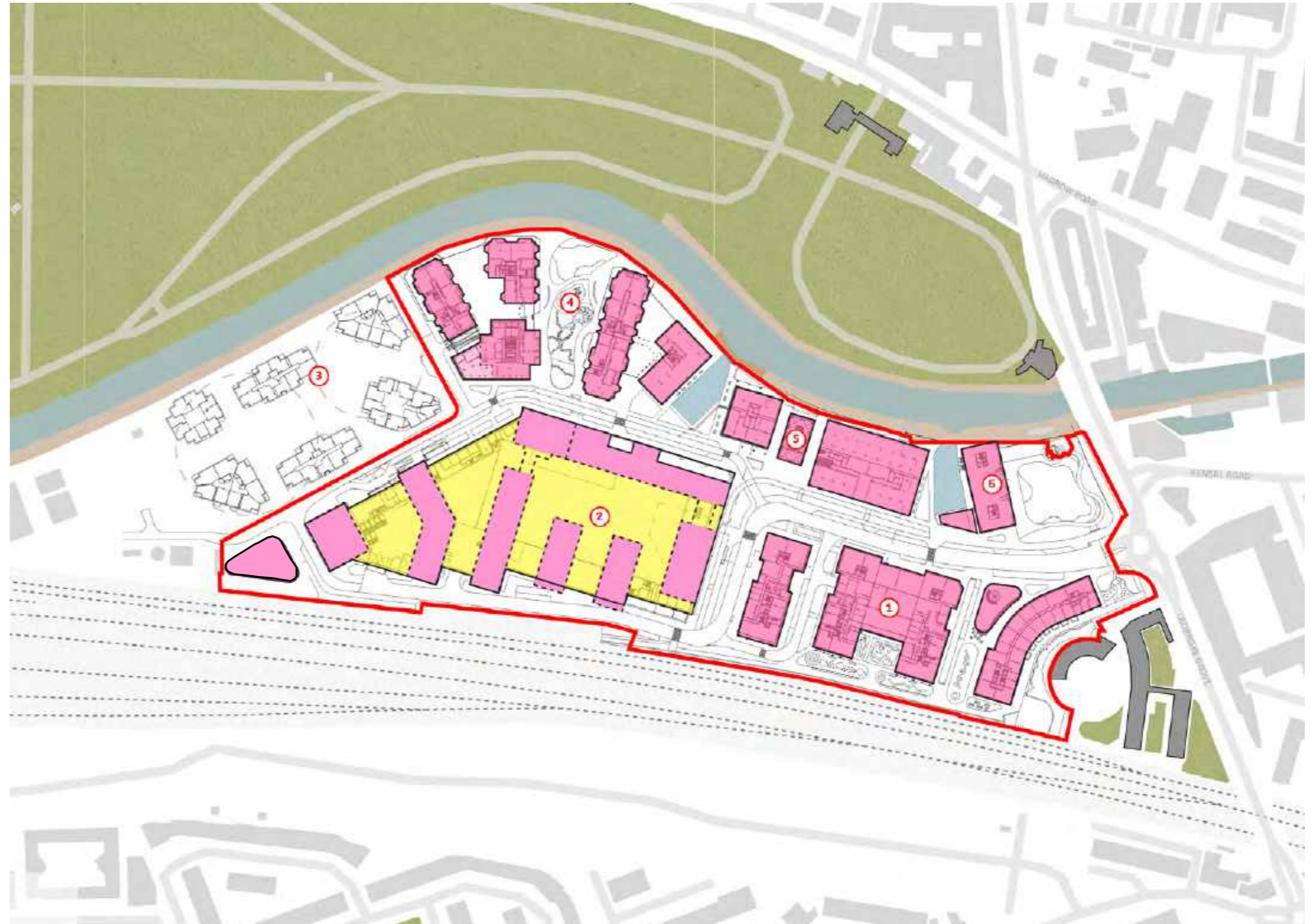
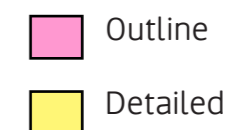

Fig 3.85: Detail Vs Outline



3.4.2 The Ground Plane



Berkeley St William Owned plot

Key

-  Outline design plots
-  Plot 02 Basement and Store at Level 00 in Detail.
-  Plot 02 - All residential elements in Outline.
-  Detailed element of Landscape and Road Network

3.4.3 Movement and Connectivity

3.4.3.1 Movement

Our masterplan vision is based on key routes across the site to connect east to west, south to north.

The route across the centre of the site east to west connects Ladbroke Grove to the entrance of the new superstore and the canal bridge to the cemetery (part of the Berkeley St William Scheme, which is expected to be included within a future planning application relating to the land owned by St William which is referred to in this document as 'plot 3'). The south to north route from the rail corridor to the canal links the potential future bridge across the train tracks to the canal edge. This bridge does not form a part of this application, although a bridge landing point has been safeguarded in the proposals. At the centre of the site at the intersection between these 2 routes is the entrance to the new Sainsbury's store.

Our movement strategy is designed to accommodate all the possible vehicle movements within the site as part of a recognisable extension of the surrounding street network. We propose a high street linking Ladbroke Grove to the new store entrance as the primary pedestrian, cyclist and vehicle artery within the site. Traffic and deliveries for the store, the bus network, residential visitors and delivery and service vehicles will all use this road to access the various parts of the site. We have enlisted the support of specialists Space Syntax who bring a unique take on the connection between transport data analysis and the experience and hierarchy of the street scape.

Pedestrian routes along the canal towpath will be preserved and enhanced and a new pedestrian route will be created along the southern edge of the masterplan (also suitable for emergency vehicles).



Fig 3.86: Movement principles

3.4.3.2 Cyclists

The canal towpath provides the primary off road existing cycle route connecting east to west.

The canal path currently combines both pedestrian and cycle routes on one narrow path. The development will improve this infrastructure by widening the path and by improving visibility along the canal edge.

The Canal path connects the site to Paddington and to TFL cycle route C44. Should a southern bridge to north pole be provided, a connection south could be made to cycle route C27.

The on site cycle strategy provides a segregated cycle lane through the centre of the site from the Ladbroke Grove junction through to the potential bridge access. Quiet, cycle friendly links between the canal towpath and the centre of the site and roads that have been designed to support cyclists in traffic as an extension of the wider London road network.

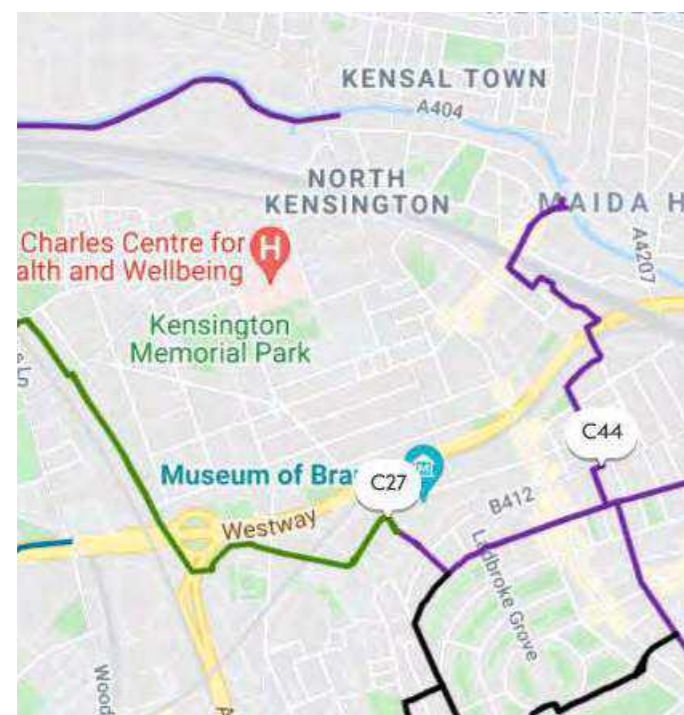

Fig 3.88: An extract from TFL cycle map

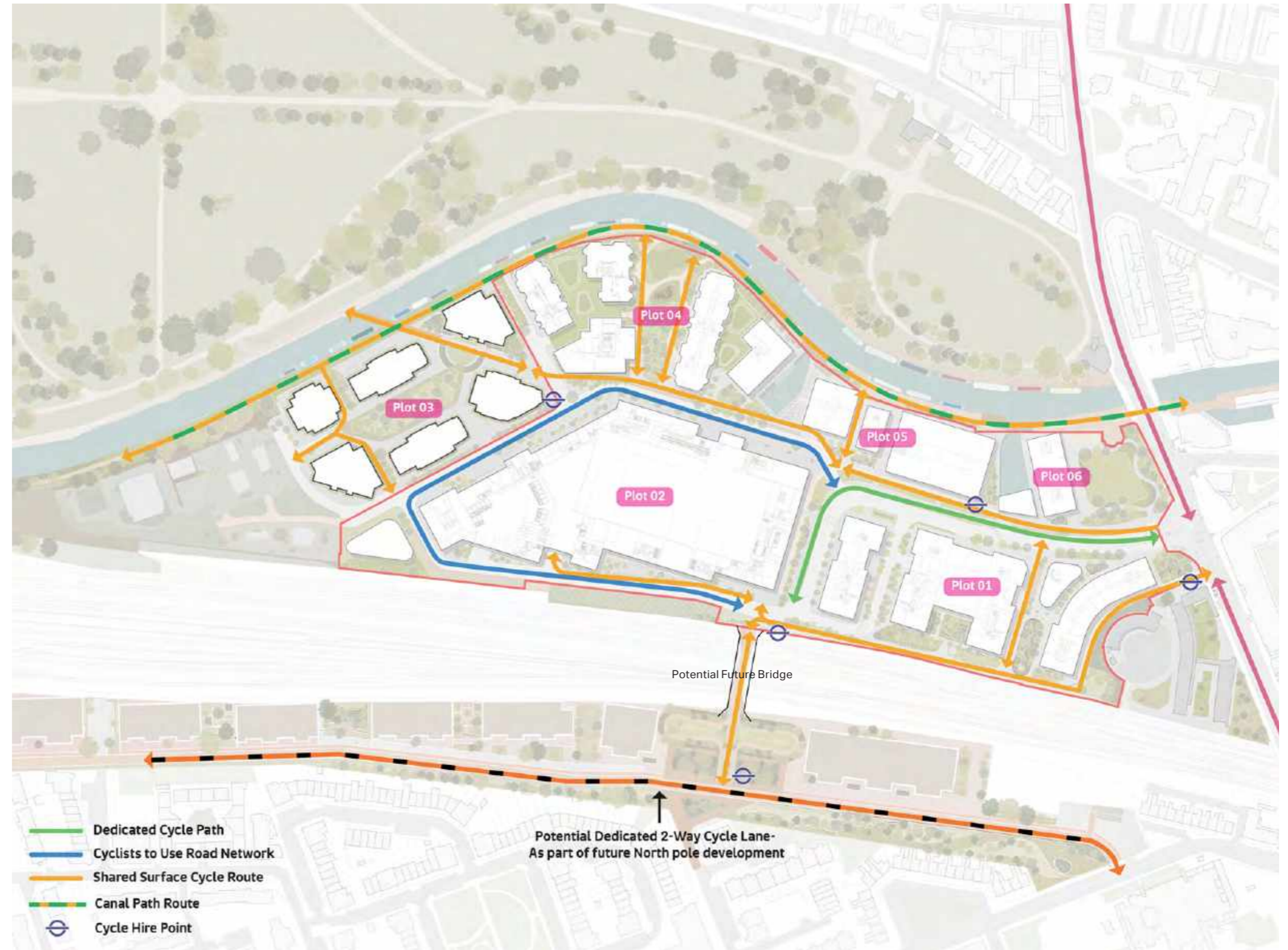

Fig 3.87: Cycling network

3.4.3.3 Pedestrians

The existing site does not offer pedestrians any access, with much of the Western side closed off to public access due to the location of storage compounds, the former gas holder site and national rail access compounds.

A single route to the west of the site is provided by the towpath to the canal which links the site to Paddington in the east, and OPDC in the west.

Our proposals seek to improve the unfriendly pedestrian environment to improve permeability through the site.

The towpath forms an important leisure route for those that know it, and longer distance connections on foot by bike from Scrubs Lane to Ladbrooke Grove. The route is not well used at night being poorly lit and separated from any nearby neighbours.

Pedestrian access to the store is provided either via the canal towpath, or via a pedestrian crossing on Canal Way at the front of the site and a covered walkway across the stores car park.

The existing roundabout at the front of the site is not easy to cross and has a steady flow of traffic most of the day and night. Our proposal adopts signalled crossings which will allow for safer pedestrian and cycle crossings.

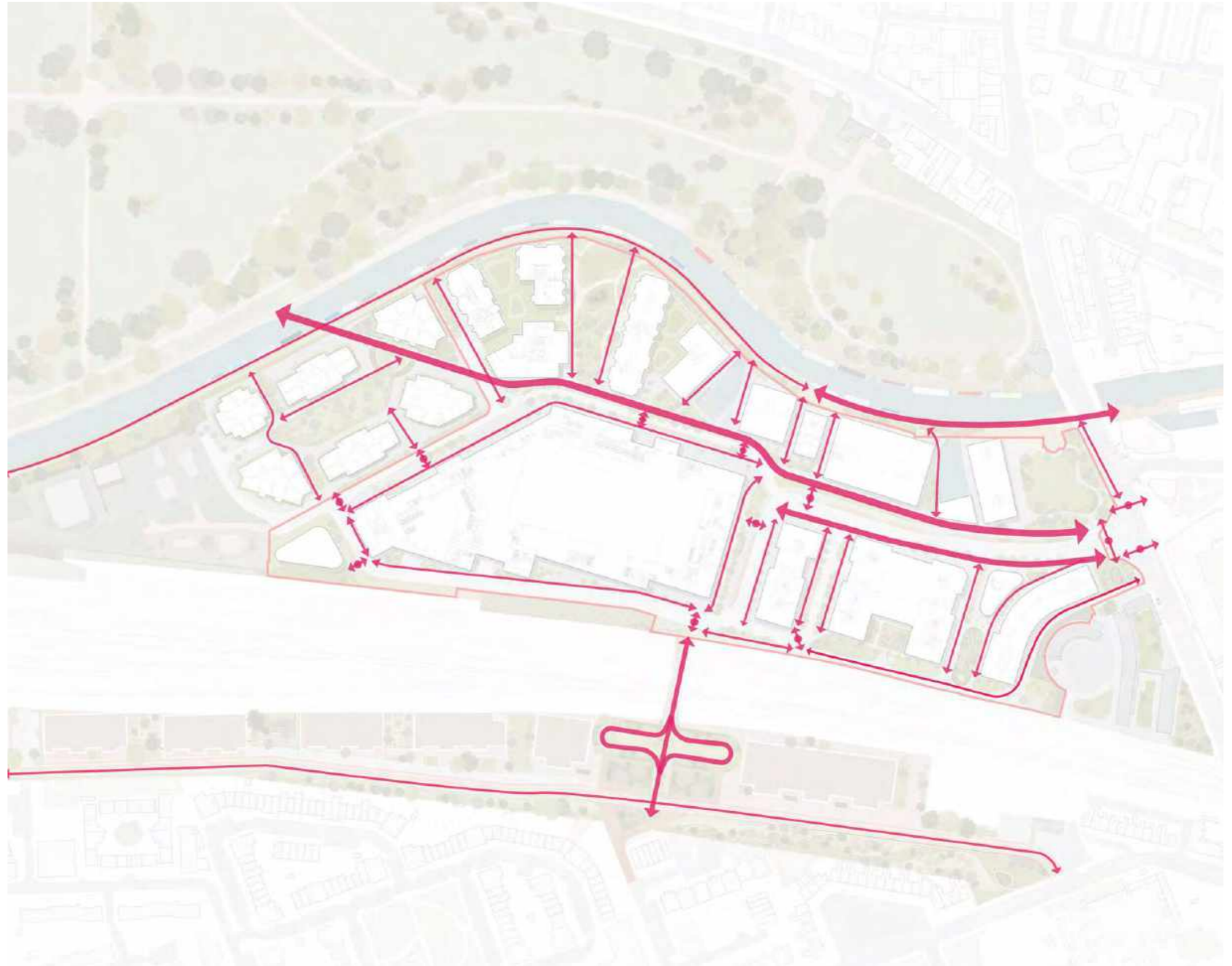

Fig 3.89: Pedestrian routes

3.4.3.4 Bus Network

Our approach to the bus network has been developed alongside our transport specialists WSP and in consultations with TFL and RBKC Transport planners.

There are currently 7 routes with stops on the site. Our strategy brings 3 bus routes to the centre of the site, to provide connection to the store, high street and heart of the neighbourhood centre. These buses then exit the site and continue northwards.

A longer loop of 1 bus route will travel to the far west of the site to connect the neighbouring residents to the bus network. This bus route terminates within the site.

New facilities for bus drivers will be provided at the new bus stand in the south west corner of the site.

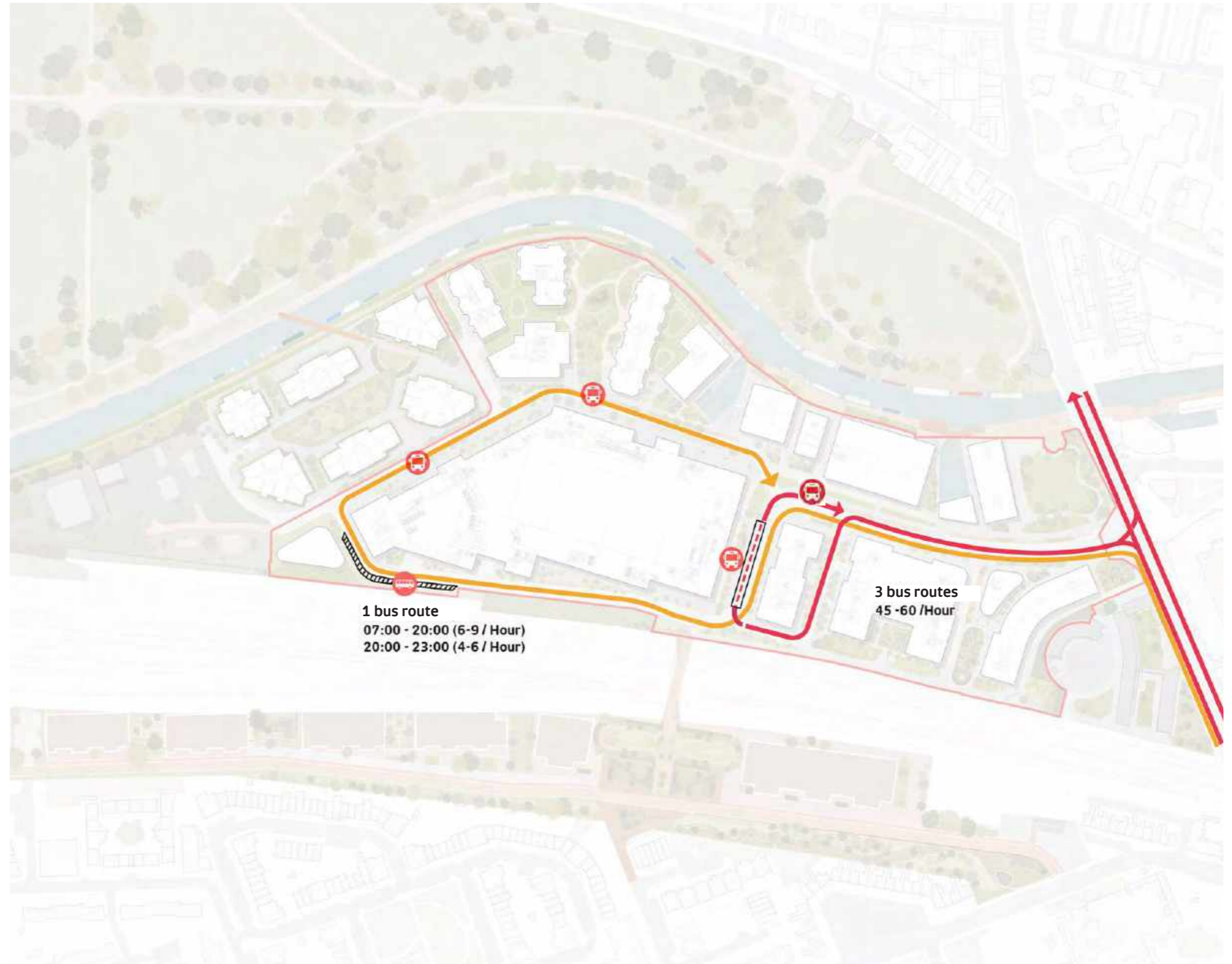

Fig 3.90: Bus network

3.4.3.5 Space Syntax

Space Syntax provides creative expertise in architecture & urban planning. Combining global design experience with advanced digital technologies, they model social, economic & environmental impacts of development on mobility, land value & health.

At Ladbroke Grove Space Syntax provided us with an analysis of the movement network and the effect the potential bridge connections could make to both the land south of the train tracks and the connection across the cemetery to Kensal Green tube (part of the Berkeley St William teams proposals).

Their analysis shows the benefits of both connections, particularly the connection through to Kensal Green tube. Its also reinforces the masterplan concept of the east west access through the site forming an important artery for movement within the site.

Existing Street Type Analysis



Existing Street type analysis Global and local scales



Proposed Street type analysis Global and local Direct avenue + cemetery link



Proposed Walking distance from site Direct avenue + cemetery link



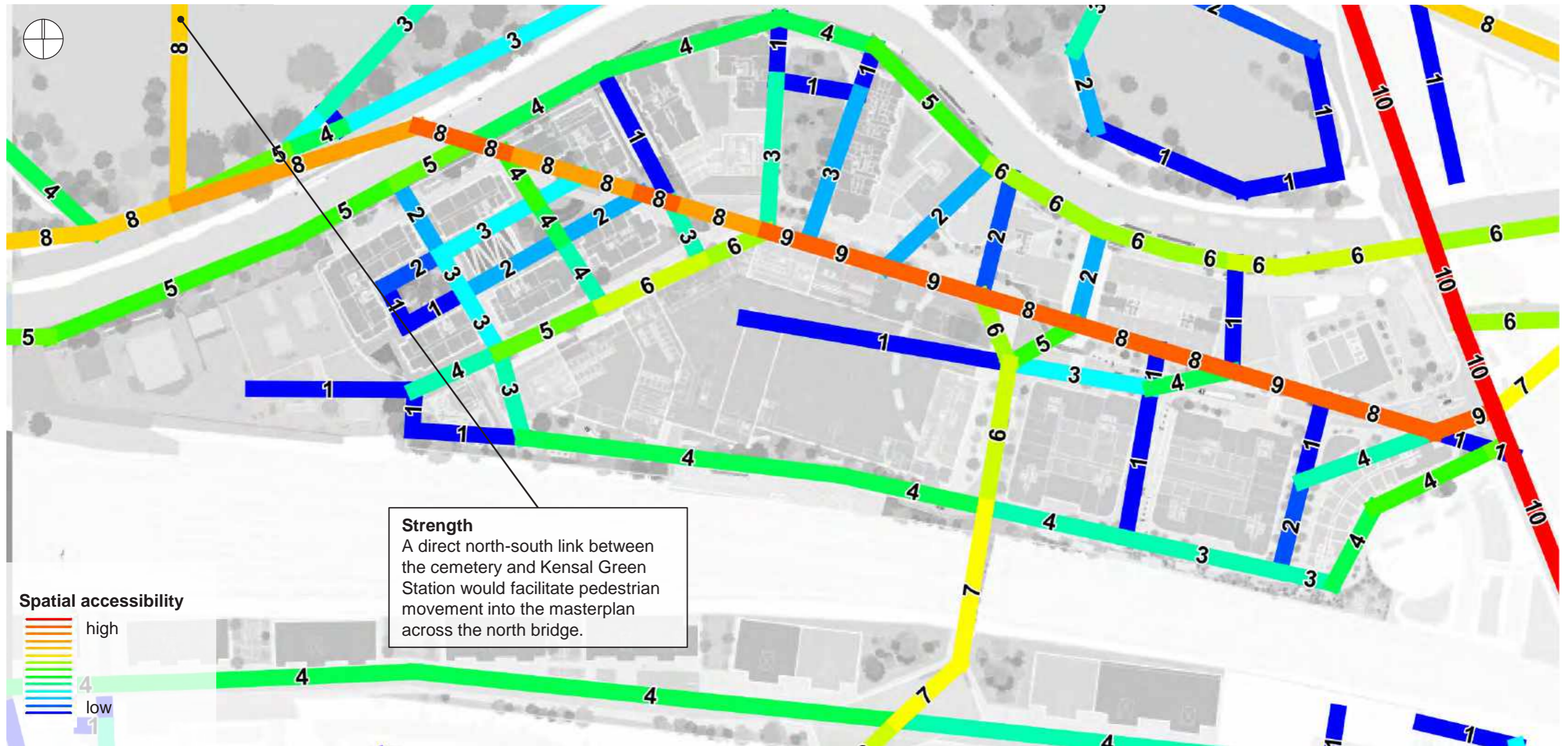

*NOTE: Study carried out on the previous iteration of the masterplan layout (2021). Diagram re-used here as context

3.4.4 New Neighbourhood Centre

The eastern portion of the masterplan that connects to Ladbroke Grove is seen as a neighbourhood centre capable of supporting the new population of residents on the site and offering a new set of services for those living close to the site. We see this part of the masterplan as supporting a range of ground floor uses, doctors, dentists, shops, restaurants, business and workshops.

3.4.4.1 The New Wharf

The new wharf is seen as a leisure destination and a place for cafes and restaurants to congregate and enjoy the relationship with the water frontage. The entrance to the store forms a backdrop to this key public space.





3.4.4.2 The Avenue

The high street forms a key piece of the masterplan, connecting Ladbroke Grove to the centre of the site and the entrance to the new store. The intention here is to line the high street with shops and workplaces that connect to the public realm via welcoming open shop frontages.

3.4.4.3 Southside

The ground floor spaces within plot 01 are earmarked for a wide variety of uses. It is intended that these spaces could be offered to a wide variety of users as either start up workspace or workshop space for creative businesses. There is also space here for services such as dentists or a creche.

Key

	Food and beverage
	Retail
	Workplace
	Other amenity
	Community

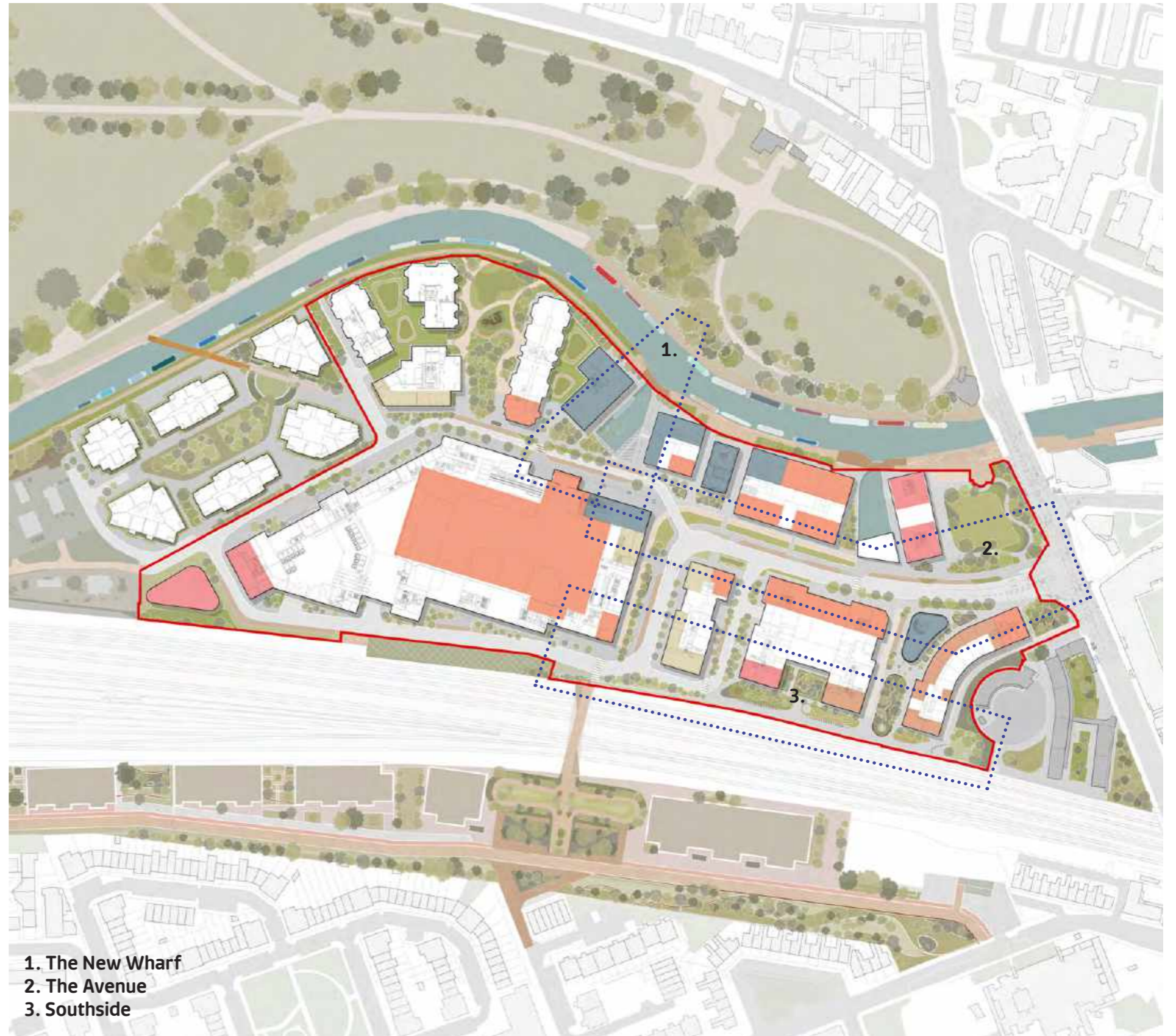



3.4.5 Environmental Quality

3.4.5.1 Project Ambition

A Sustainability Statement has been prepared to support the planning application by sustainability specialists Hoare Lea.

The report presents the Sustainability Strategy for the Proposed Development which has been informed by national, regional, and local policies – that is, National Planning Policy Framework (NPPF), Building Regulations Part L, the Greater London Authority (GLA) London Plan (2021), the London supplementary planning guidance (SPG) on Sustainable Design and Construction (2014), London Plan Guidance on Circular Economy Statements and the current Royal Borough of Kensington and Chelsea Local Plan (2019).

The Five Capitals Model is being applied to capture the multi-faceted sustainability benefits that the Proposed Development potentially brings to the Application Site, local community, surrounding businesses, and future building users. The five capitals applied comprise of the following.

Natural Capital – enhancing the environment

Human Capital – people centred design

Social Capital – partnerships and collaboration

Physical Capital – designed for performance

Economic Capital – productivity and growth

Please refer to the latest energy strategy by Hoare Lea included in this planning application.

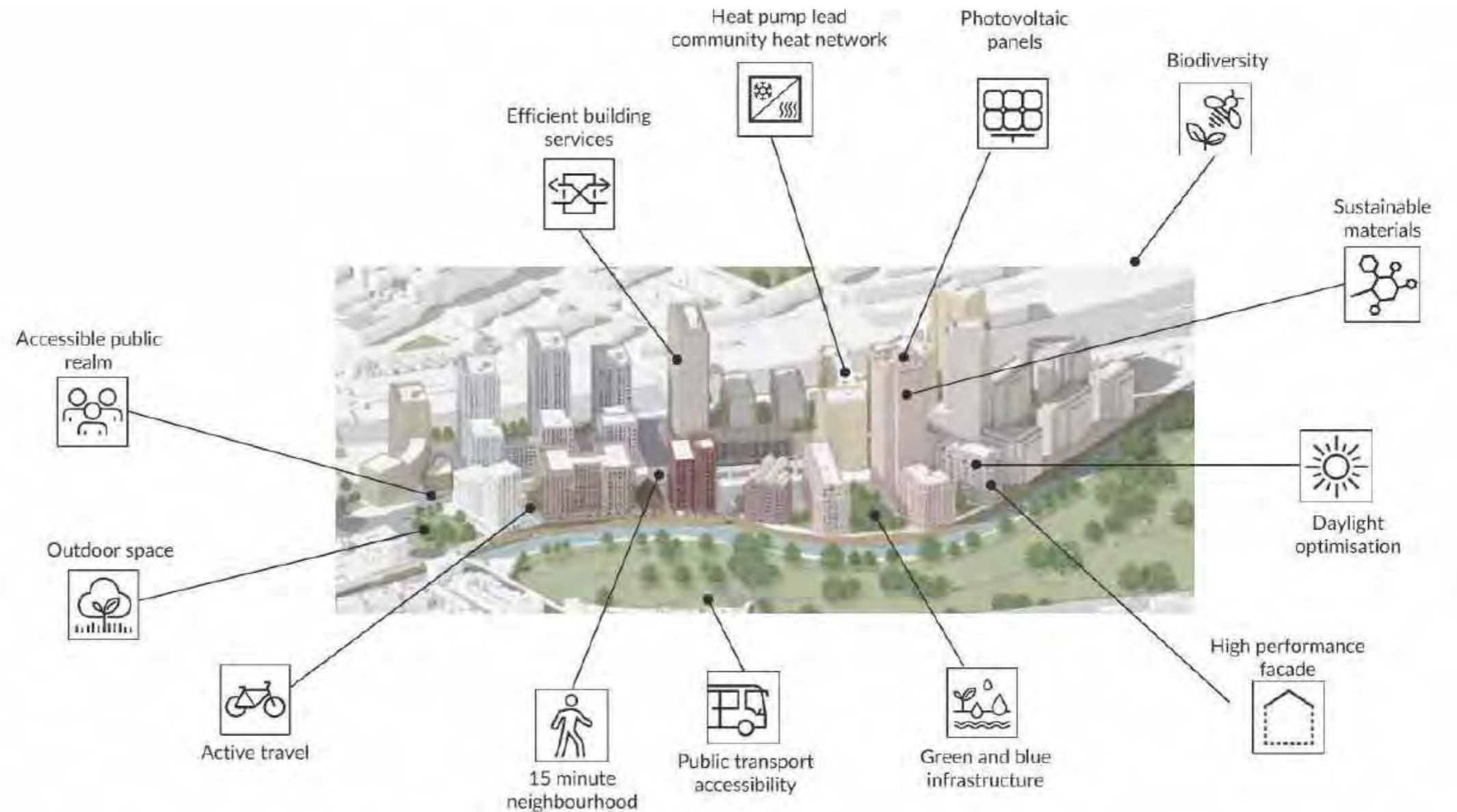

Fig 3.91: Site sustainability strategy

3.4.6 Key Principle 07: Height and Massing

Our masterplan height and massing strategy is based on the broad principle that tall buildings should be positioned at the southern side of the site towards the train track and lower level buildings should be positioned on the northern side of the site towards the Grade I listed landscape of Kensal Green Cemetery.

This approach is supported by RBKC's SPD height and massing diagram, as indicated by the purple gradient shown below.

Another key element of the masterplan massing strategy relates to contrast in scale and mass and the benefits of this approach in allowing the design team to modify mass to define key character areas and to provide appropriate daylighting conditions at ground floor level.

The adjacent diagram describes the planning stage approach to tall building location and building height.

3.4.6.1 Tall Building Markers

The masterplan proposes two tall 'marker' buildings, Plot 2.1 and Plot 4.1. One of these buildings is shown at the head of the high street the other at the centre of the site where the sweep of the canal creates the greatest distance between the canal and the train track. This marker also serves to signal the bridge crossing the canal.

The two locations for tall buildings sit within zones identified as part of the adopted SPD by the council as areas where taller buildings could be located.

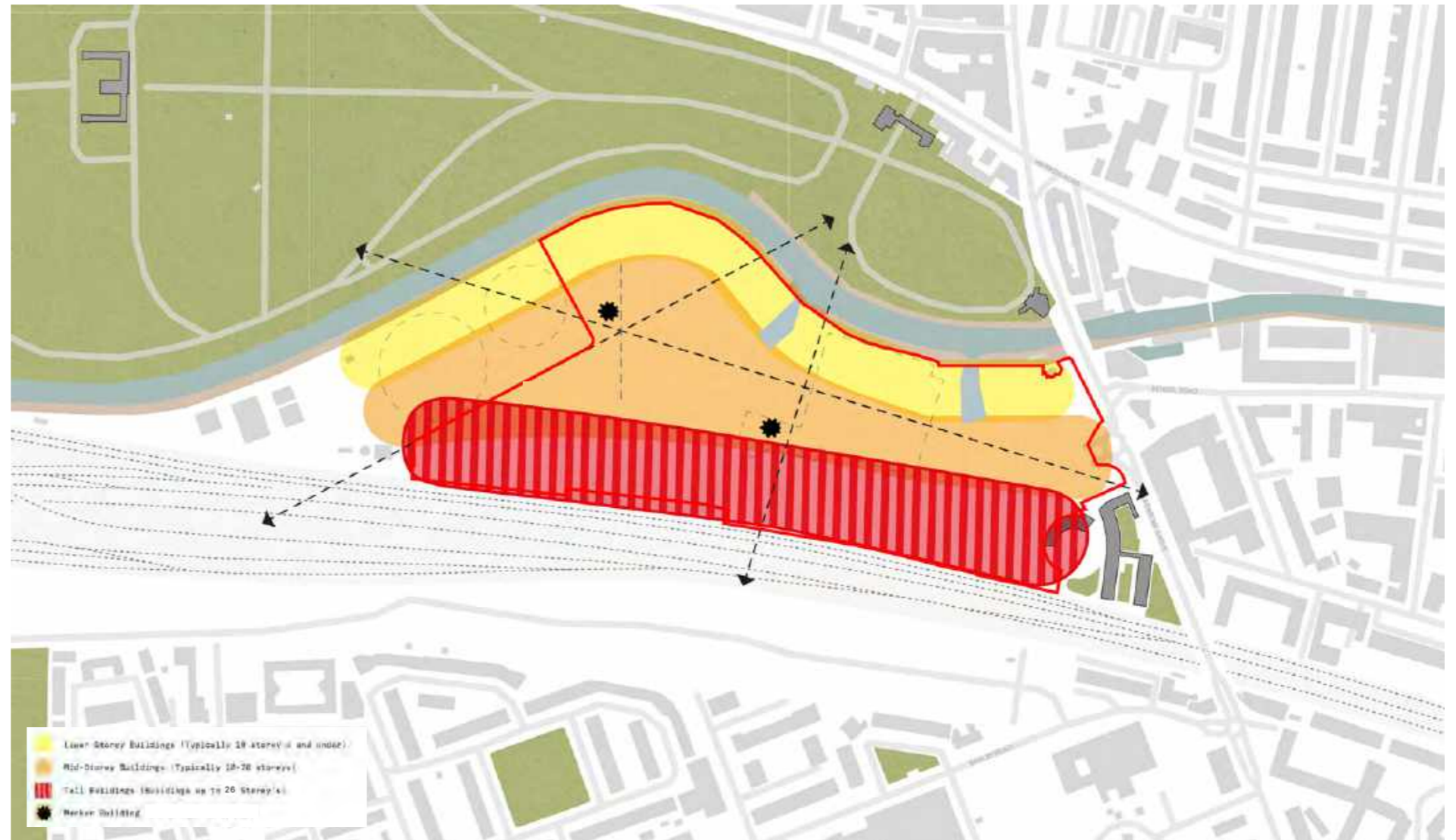

Fig 3.93: Height and Massing Concept Diagram

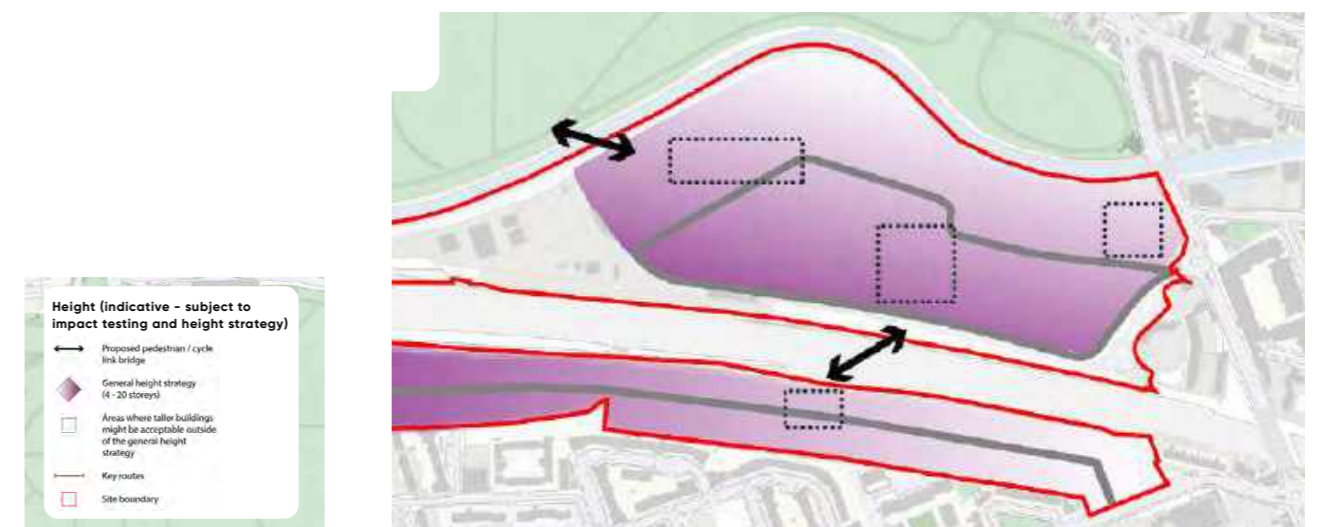

Fig 3.92: SPD Height and Massing Diagram

3.4.6.2 Locating Tall Buildings

The masterplan height and massing strategy is based on the principle that lower level buildings should be positioned towards the northern edge of the site at the canal edge and taller buildings should be positioned towards the train tracks at the southern edge of the site.

The massing strategy is also based on the principle that rather than trying to adopt a consistent building height across the site, the design should adopt the principle that contrast and variation in building should be applied. This allows the character of buildings to adapt to their specific location within the site, framing key public realm spaces where necessary.

3.4.6.3 Location of marker buildings

We are proposing two locations for our tallest buildings. These buildings act as markers within the masterplan at key intersections between the site and its surroundings at key public spaces within the site.

At site 1 on the adjacent drawing, we propose a tall building that responds to the location of the store entrance, the central high street through the site and the north south connection offered by the future provision of the railway bridge connection. At site 2, we propose a tall building that marks the centre of the site and the junction between the prevalent east west geometry of the proposed route through the site and the south west alignment of west drive.

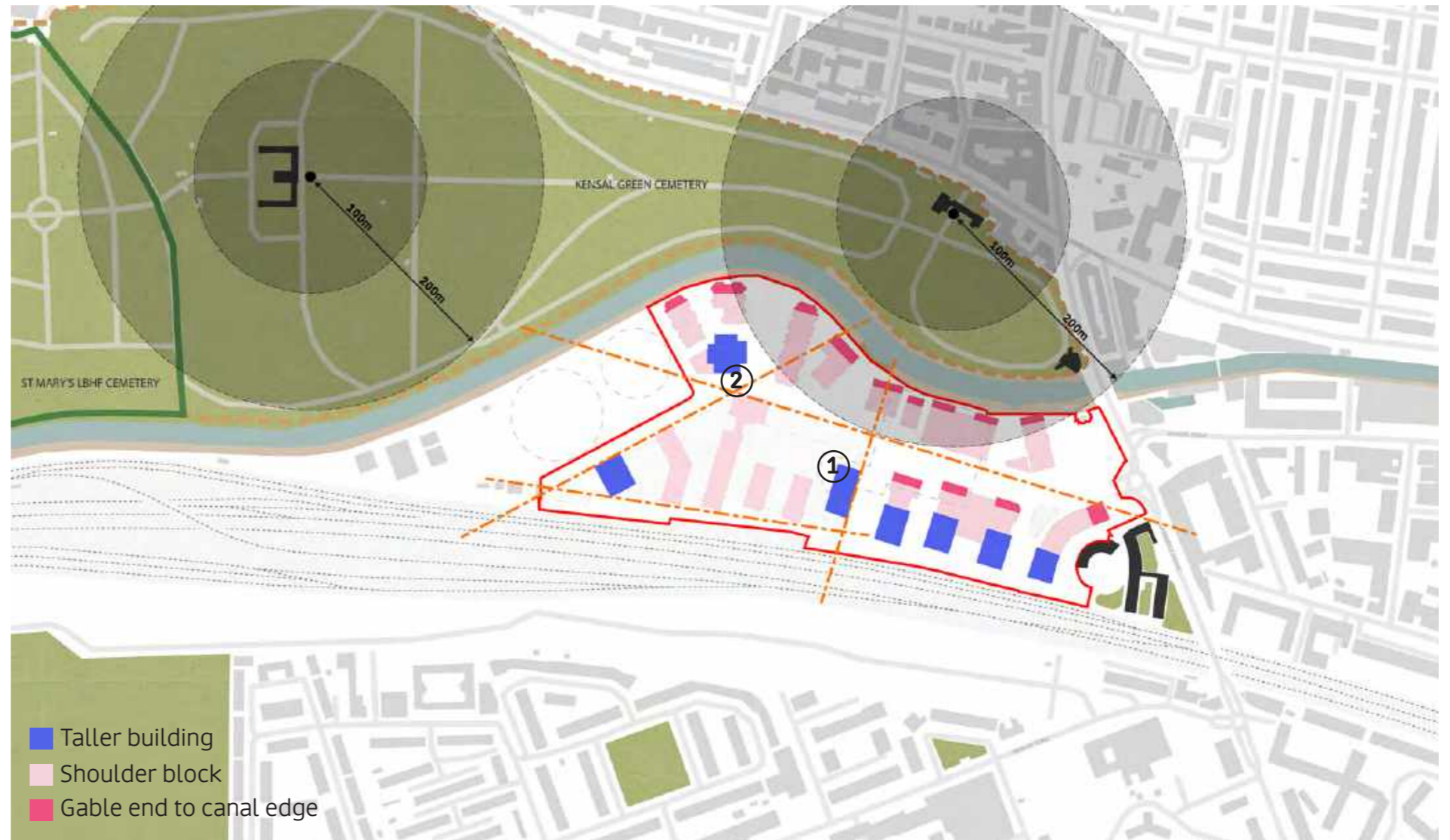

Fig 3.94: Positioning tall buildings

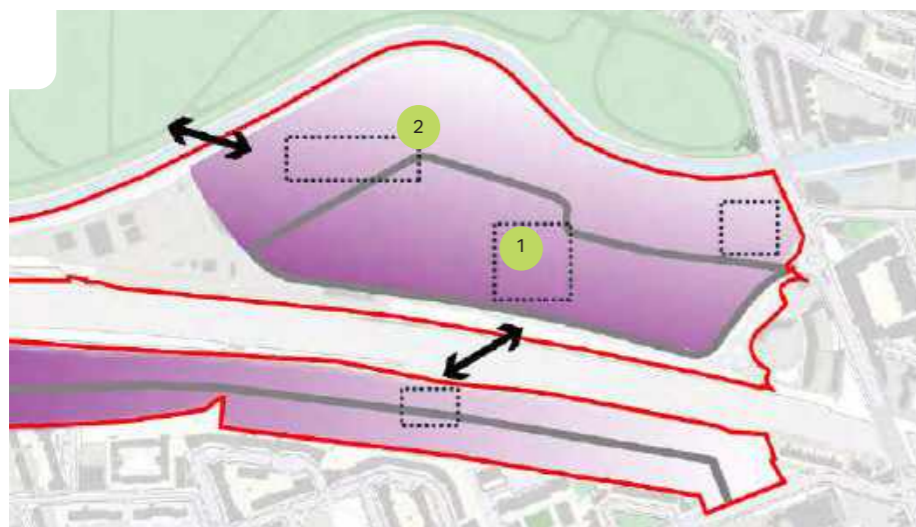

Fig 3.96: SPD Height and Massing Diagram - Tall building locations



Fig 3.95: The gas works site



Fig 3.97: A concept diagram for tall building locations.

3.4.6.4 Response to Heritage

Our response to creating a new backdrop to the cemetery has been to align buildings with their short ends to the canal and cemetery, rather than their long sides. As illustrated below, not only do the buildings fronting the canal and cemetery present their narrow flanks to this sensitive area, but they are limited to typically 10 storey's in height. Building 5.1 stands taller at 14 storey's where its additional height serves to signal the reinstated basin. The building has been carefully massed to present a slender facade to the canal edge, to limit its overall impact.

This has the benefit of reducing the visual impact of the new buildings by allowing gaps between buildings that offer longer views into the centre of the site and gaps between buildings that allow views to the sky.

With the exception of the western marker building, all buildings over 14 stories in height have been positioned along the southern edge of the site in order to reduce their visual impact when viewed from the cemetery.

This location for taller buildings along with the gaps between buildings described above serves to reduce the impact of building height on the cemetery, particularly in views from the eastern section of the cemetery around the dissenters chapel.

Our approach to building height on plot 06 has significantly changed since the designs prepared in December 2021. Refer to section 4 for a summary of the design evolution. Where previously we proposed a 20 storey residential building at the front of the site, we have now adopted an approach that includes for a 12-14 storey building stepped back from the site frontage. This massing approach significantly reduces the impact of massing as a backdrop to the Grade II* listed Dissenters Chapel.

The western marker (4.1) and the central marker (2.1) are located according to significant figure ground locations within the masterplan.

Building 2.1 is positioned at the head of the Avenue and at the junction of the potential bridge connection to the south. Building 4.1 is located at the central canalside garden space, and marks the onward connection to the potential future bridge connection to the cemetery (expected to form part of the Berkeley St William proposal).

The buildings are spaced sufficiently apart so as to avoid coalescence on the skyline when viewed from the north.

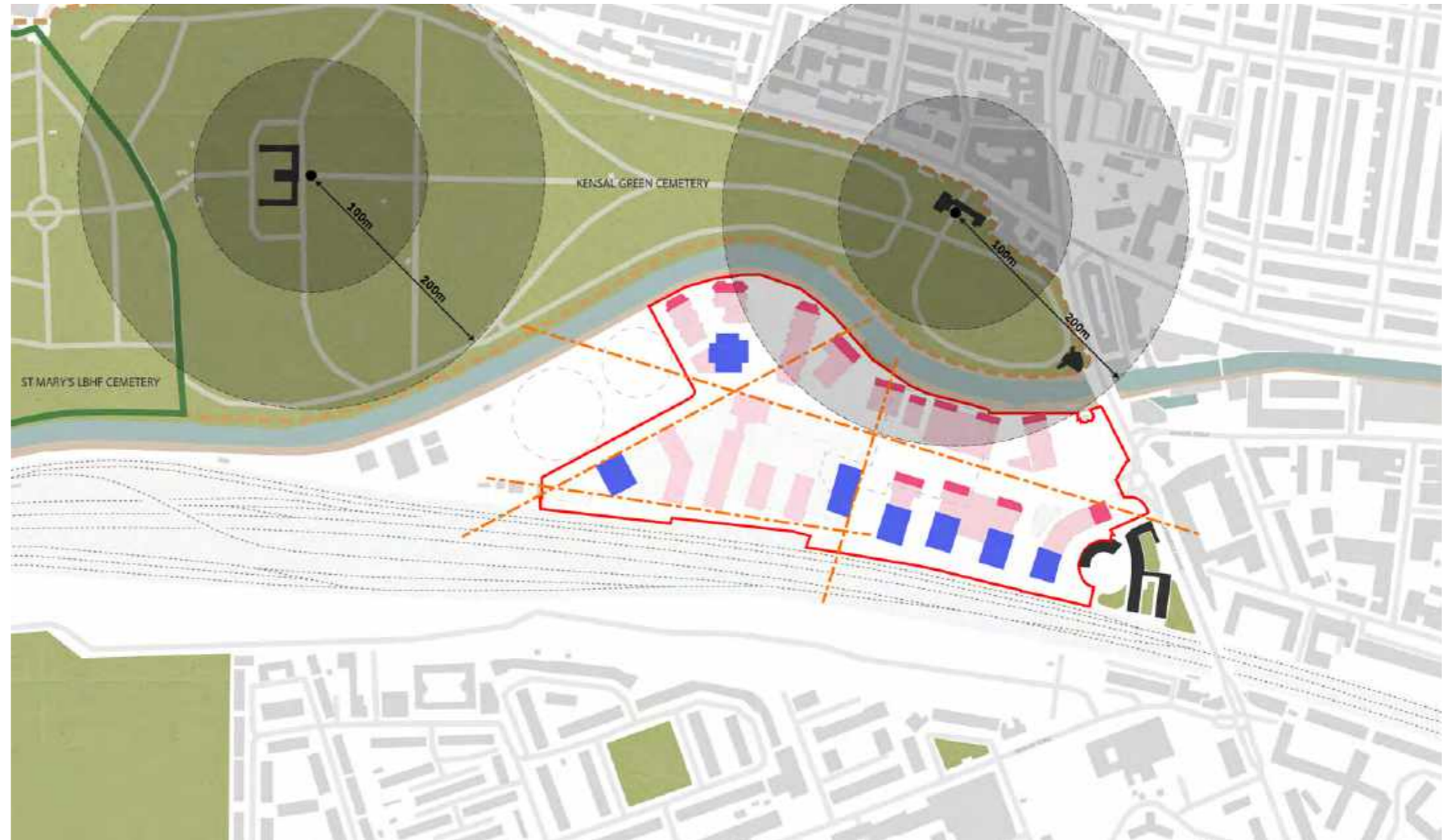

Fig 3.98: Positioning tall buildings



Fig 3.99: A diagram to describe block arrangement and relationship to the cemetery.

3.4.6.5 Environment

The masterplan approach, based on the principle of varied building heights, also allows the massing to be adapted in height and gaps between buildings created in order to provide suitable levels of daylight at ground level.

Other massing options were tested to confirm the approach to building height. These options performed worse than the varied building height option which forms the current masterplan. Lower blocks with a consistent massing height across the masterplan of 14 storeys proved to have negative effects on daylight conditions to open spaces and daylight within homes.



Fig 3.100: Key public spaces



Fig 3.101: A diagram to show the principle of gaps and steps in building mass to provide day lighting at ground level.



Fig 3.102: Diagram to show lower level buildings aligned to key public spaces.



Fig 3.103: Diagram to show tall building locations



Fig 3.104: Storey heights of buildings within the illustrative masterplan.

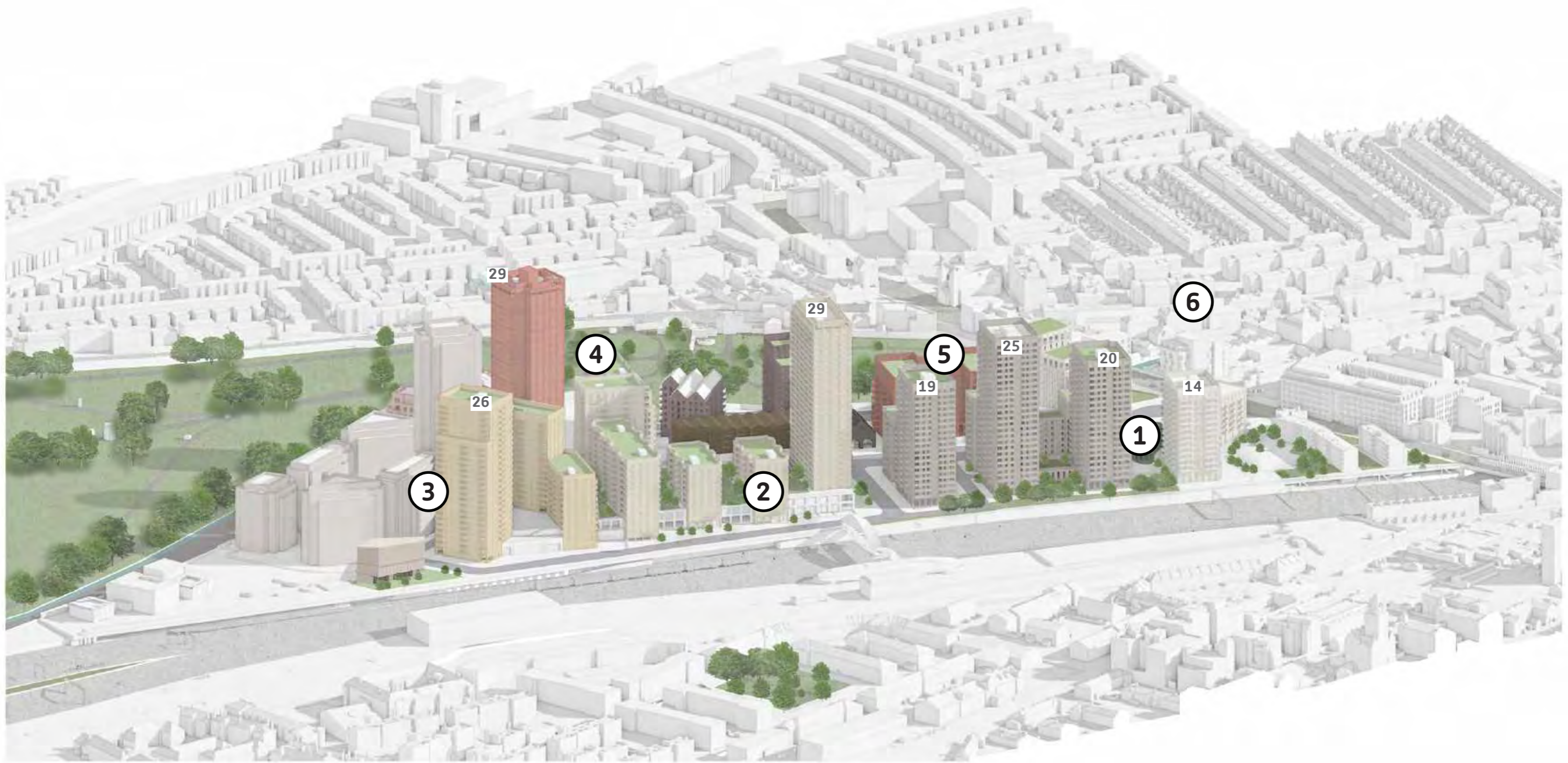

Fig 3.105: Storey heights of buildings within the illustrative masterplan.

3.5 Masterplan Phasing

3.5.1 Summary and Approach

Ballymore have prepared a construction and phasing plan to support this planning application. The phasing approach describes the projected construction strategy for the entirety of the construction period and assumes 11 years of construction. Please refer to the detailed construction phase plan within this planning application.

3.5.1.1 The path to the first phase

The adjacent diagrams describe a very broad approach to phasing on site, showing the completion and occupation of each building through the construction process. Broadly the site will be developed in 2 phases (the western half followed by the eastern half) but is likely to be broken down into smaller sub-phases.

The first phase of development will be the new store, the reclaimed basin and adjacent landscaping and the housing blocks to the western side of the basin.

This will allow the site to be opened up following the removal of the existing store. It will also make a new connection to the canal edge and will create a new destination on the canal in the form of the new basin.

The phasing steps on the following pages show a simplified version of the Ballymore construction phase plan.



Fig 3.106: Phase 01

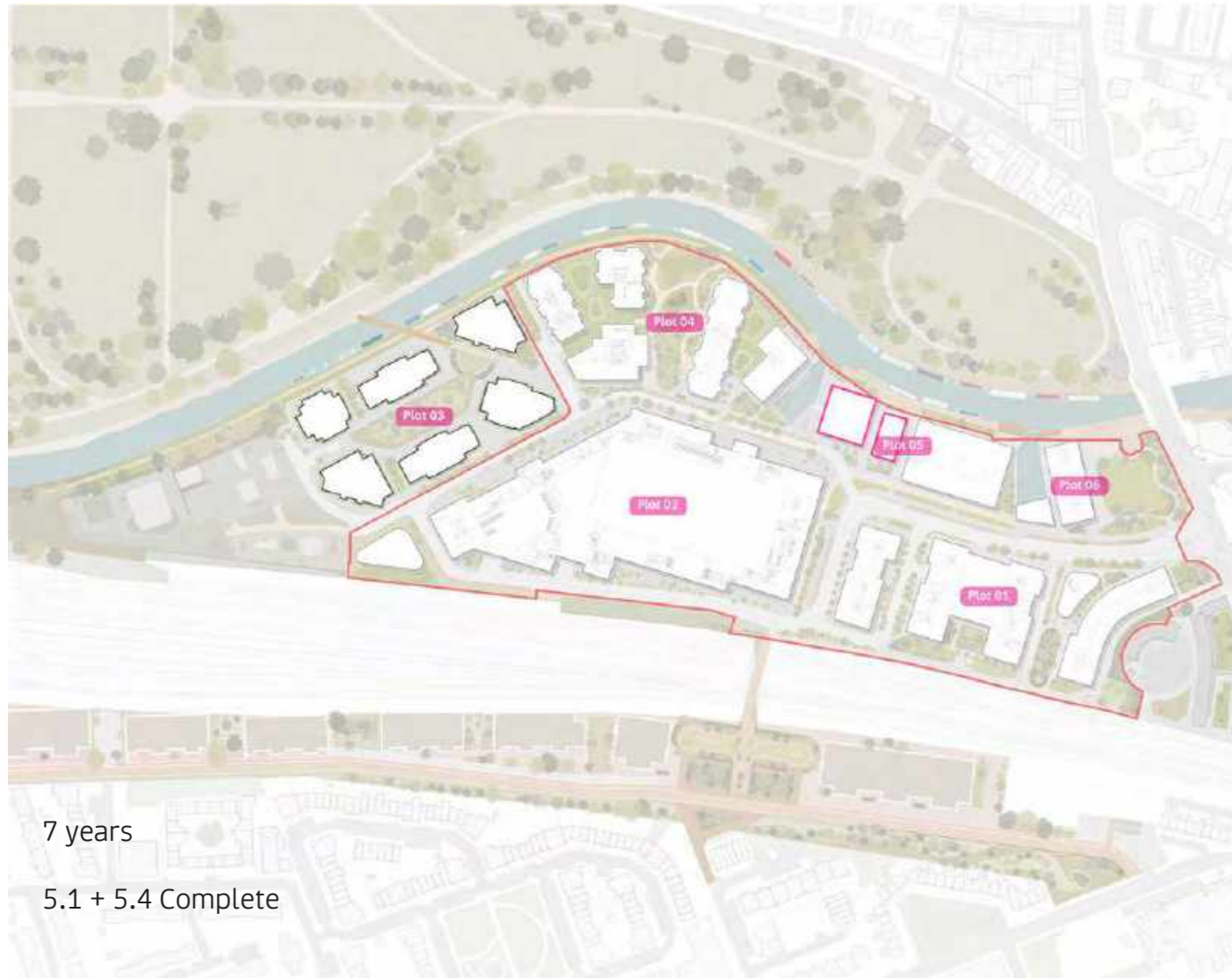

Fig 3.107: Phase 02

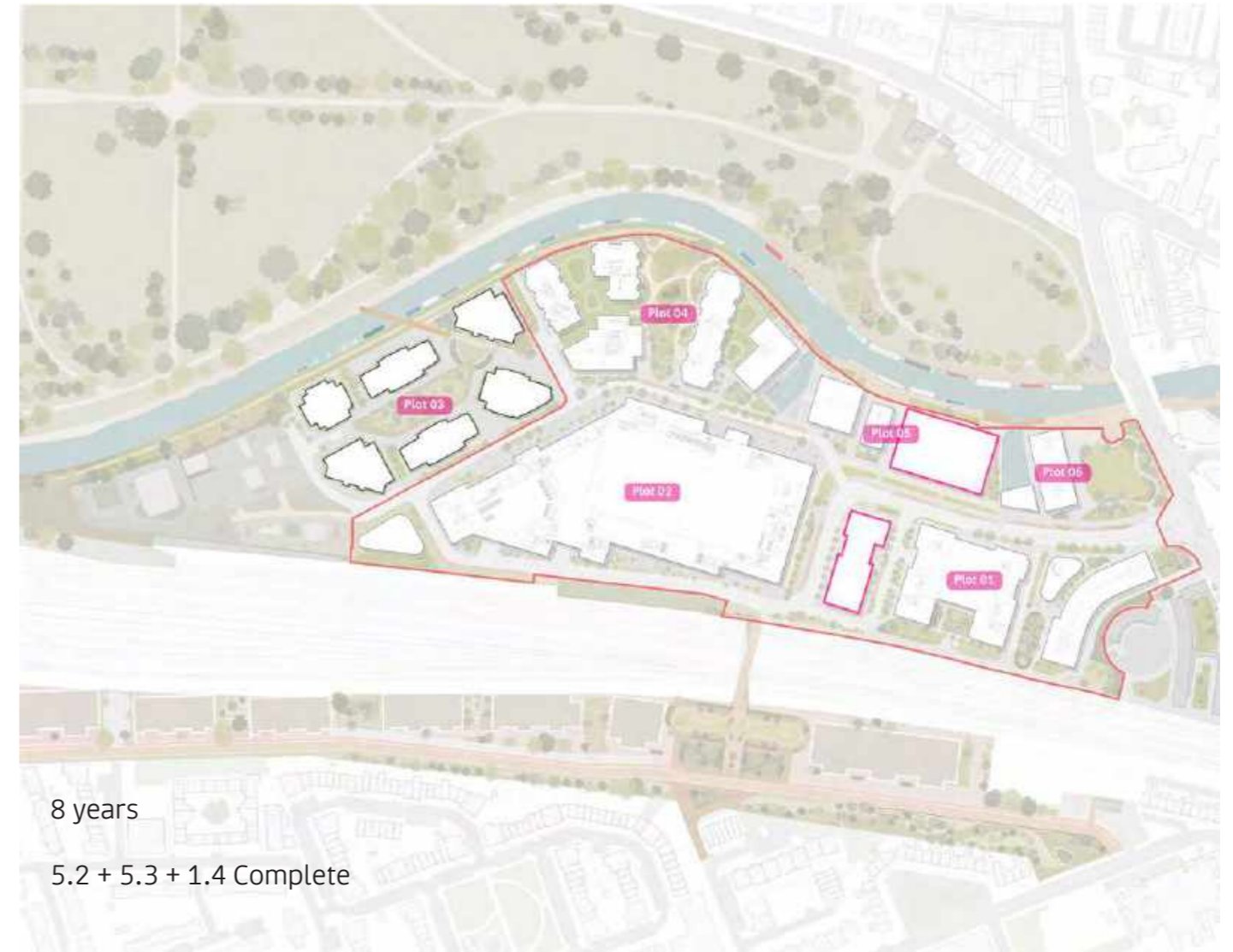

Fig 3.108: Phase 03

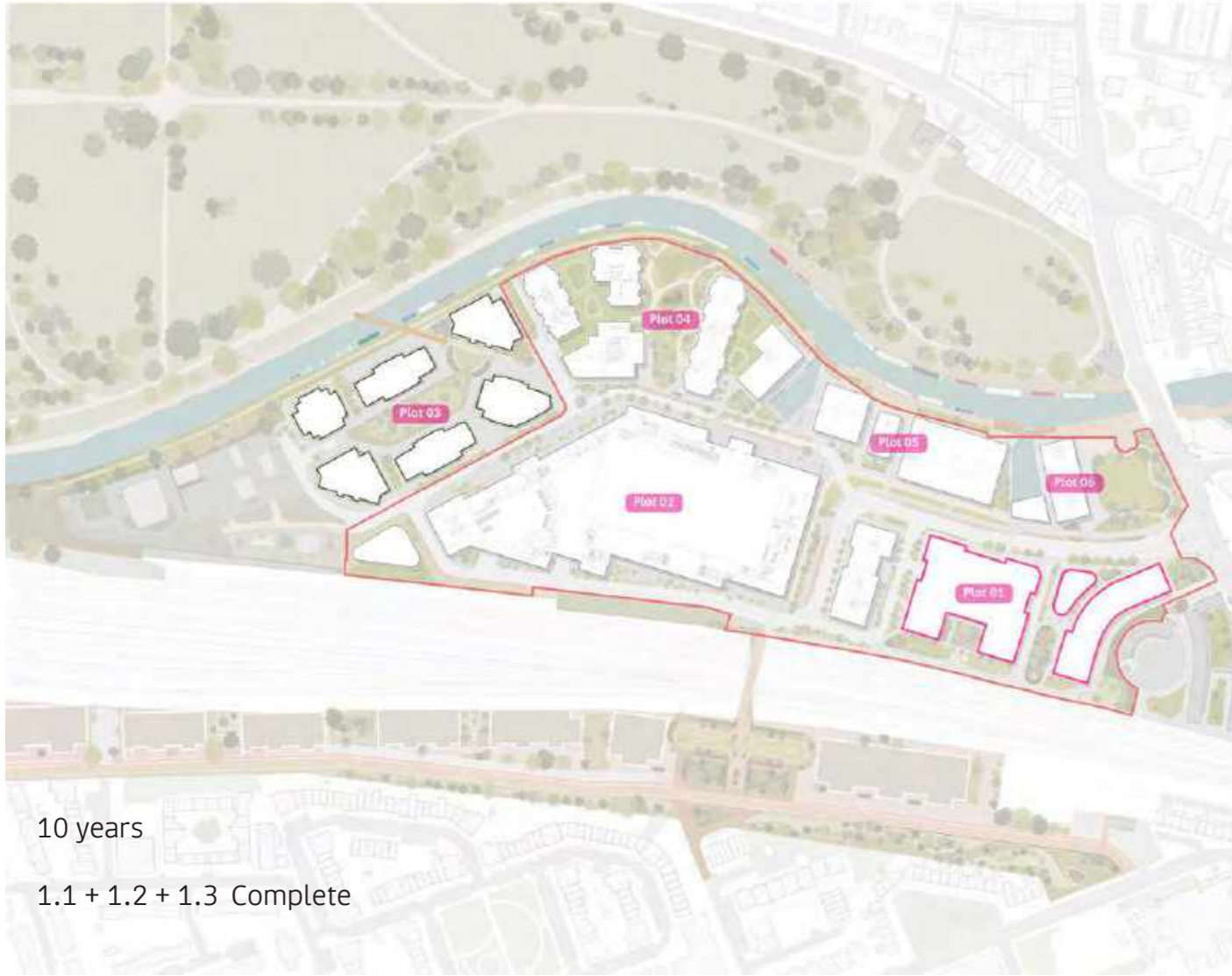

Fig 3.109: Phase 04

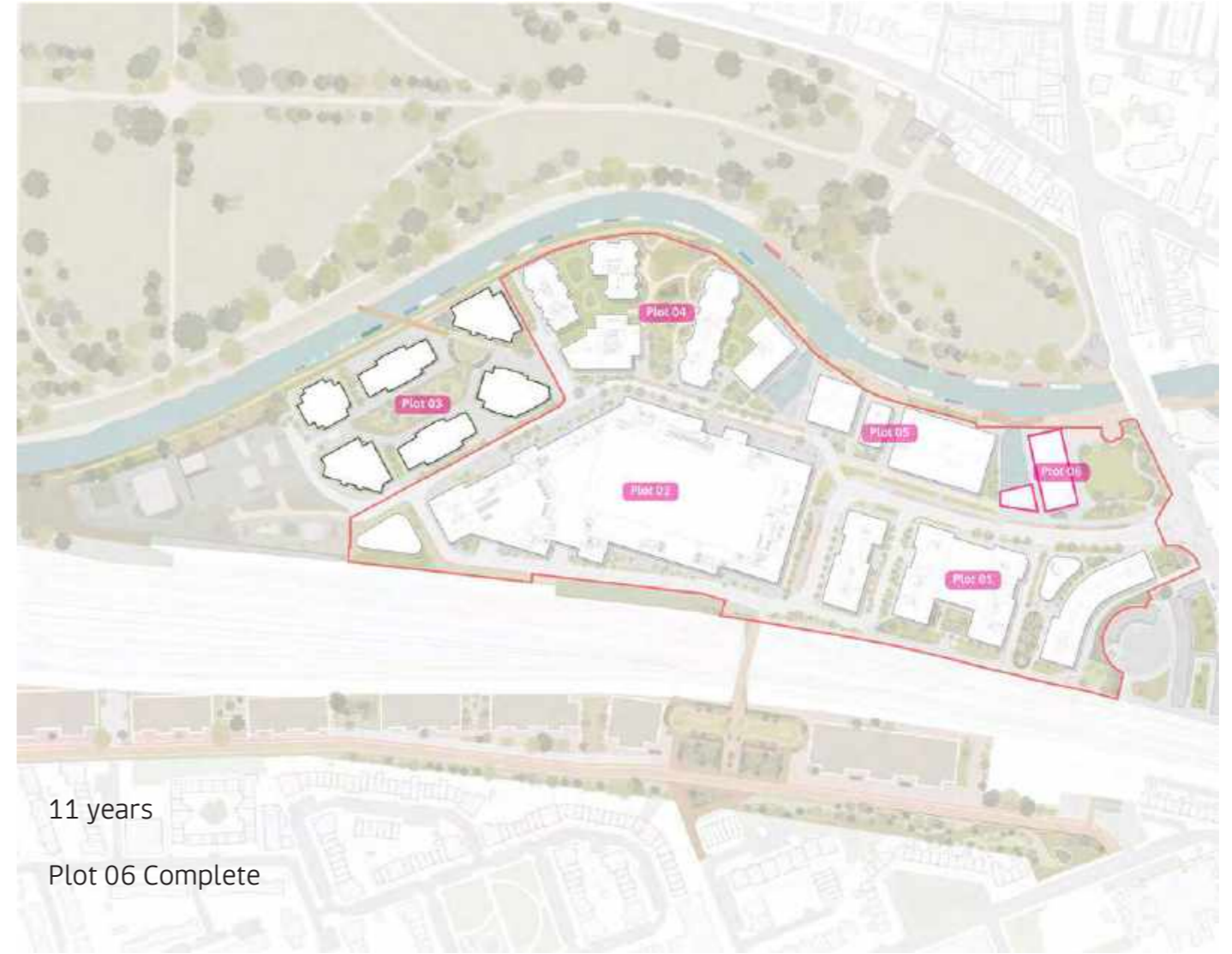

Fig 3.110: Phase 05

3.6 Existing Buildings on Site



Fig 3.111: An aerial view of the existing site.

3.6.1 Existing Sainsbury's Store

The existing store opened in March 1988; a purpose-built supermarket located on the eastern end of the site.

The single storey building (shown as point 1 on the aerial image) is fronted by a large surface level car park, providing nearly 400 parking spaces, as well as an 8-pump petrol filling station (shown as point 1A on the aerial image).

The site is dominated by vehicular access. A roundabout on Ladbroke Grove provides access to the store car park, filling station as well as access to the rear of the site along the southern boundary. At the threshold to the site there also lies an existing gas governor (point 4 on the aerial image) which will be demolished and relocated as part of the proposals.

The proposed location of the new store within Plot 2 allows the construction works to be phased in order to provide continuity of trading from the existing store to the new.

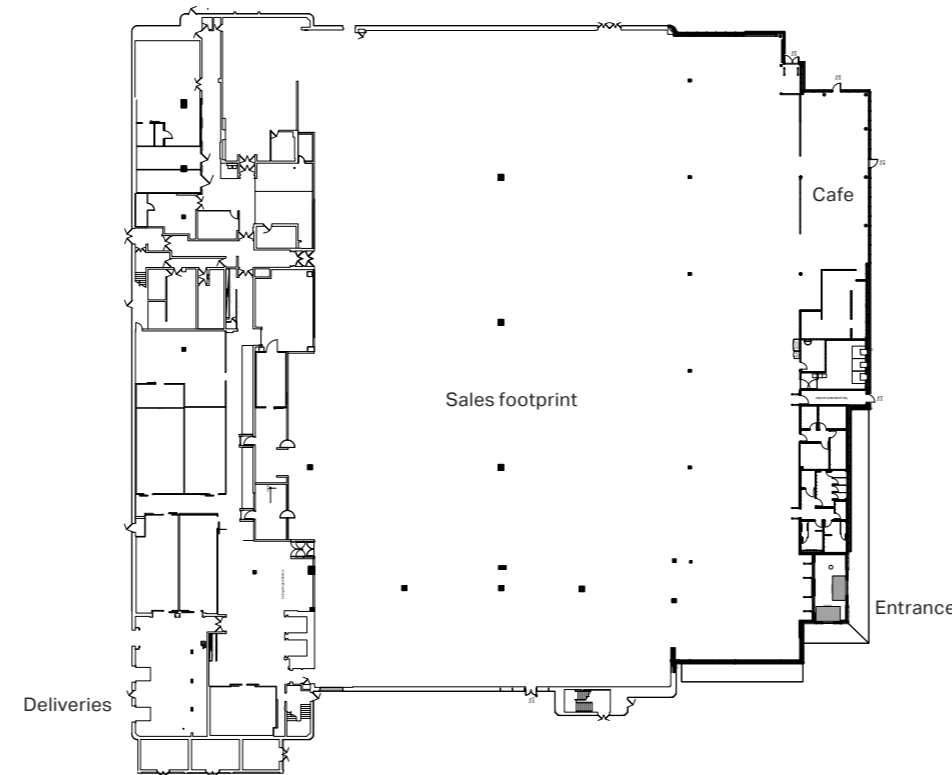

Fig 3.112: The existing store - Ground Floor Plan

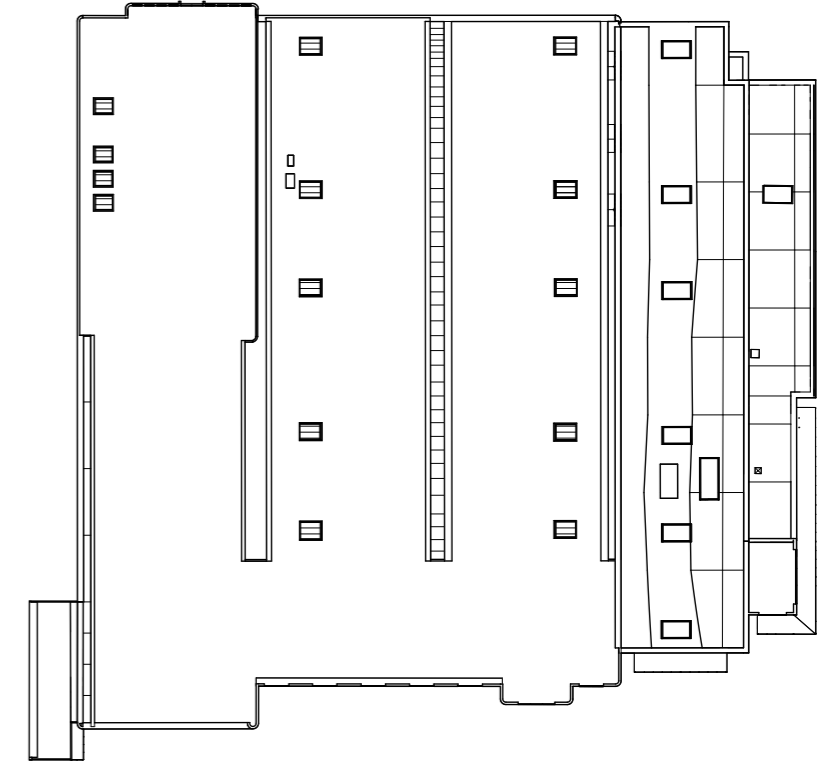

Fig 3.113: The existing store - Roof Level Plan



Fig 3.115: The existing store - Photos taken shortly after the store opened in March 1988.



Fig 3.114: The existing store - a photo of the site taken from Kensal House looking westward. Photo taken shortly after the store opened in March 1988.



Fig 3.116: Example images of the modern Sainsbury's store layout



Fig 3.117: Sainsbury's Fulham Wharf development



3.6.2 New Sainsbury's Store

Sainsbury's have developed several stores within mixed use masterplans. The images on the right are from Sainsbury's Fulham Wharf development.

The new Sainsbury's store being delivered at the Kensal Canalside site will have the following additional new features:

- Modern, well-lit, more spacious with wider aisles
- An improved store layout making it easier for customers to find what they want
- More extensive range of food and non-food products stocked in store that will complement the current range
- A bright new and larger sized café

3.6.3 The Site Entrance

The space to the northern side of the entrance junction (referred to as Plot 06 in this report) is currently made up of land owned by Ballymore / Sainsbury's, RBKC and, in the case of the former gas works water tower, a private owner.

It is proposed that Ballymore / Sainsbury's acquire the RBKC land, allowing the site threshold to be developed holistically and for the site to become an open green space, benefitting the existing local population as well as the new residents on site.

In order to achieve this, it is proposed that both the Canalside House and the Boathouse Centre be demolished during the construction period and existing residents and tenants be rehoused in new accommodation within the new development.

The following section provides an overview of these existing buildings on site and the 'Circular Economy Statement' provides additional detail regarding the justification for demolition, if required.

3.6.3.1 Site Constraints and Opportunities

As noted on the adjacent diagram. There is a significant step of approximately 4m between the level of the Ladbroke Grove canal bridge and the general site level.

A gas line runs along the western side of Canalside House resulting in a no build zone of 5m either side of the line of the pipe.

There is an opportunity to make the existing canal basin a more open connected piece of the site landscape and public realm with the demolition of the existing buildings and reconfiguration of the sports centre.

There is also an opportunity to open up the site to the canal to the north and the road to the east, improving visibility and pedestrian connections into the site.

The site forms an important part of the annual Notting Hill Carnival with the Mastermind Soundstage having taken the Canalside House position since the early 1990's. The new public space would be designed to allow it to remain part of the annual carnival.

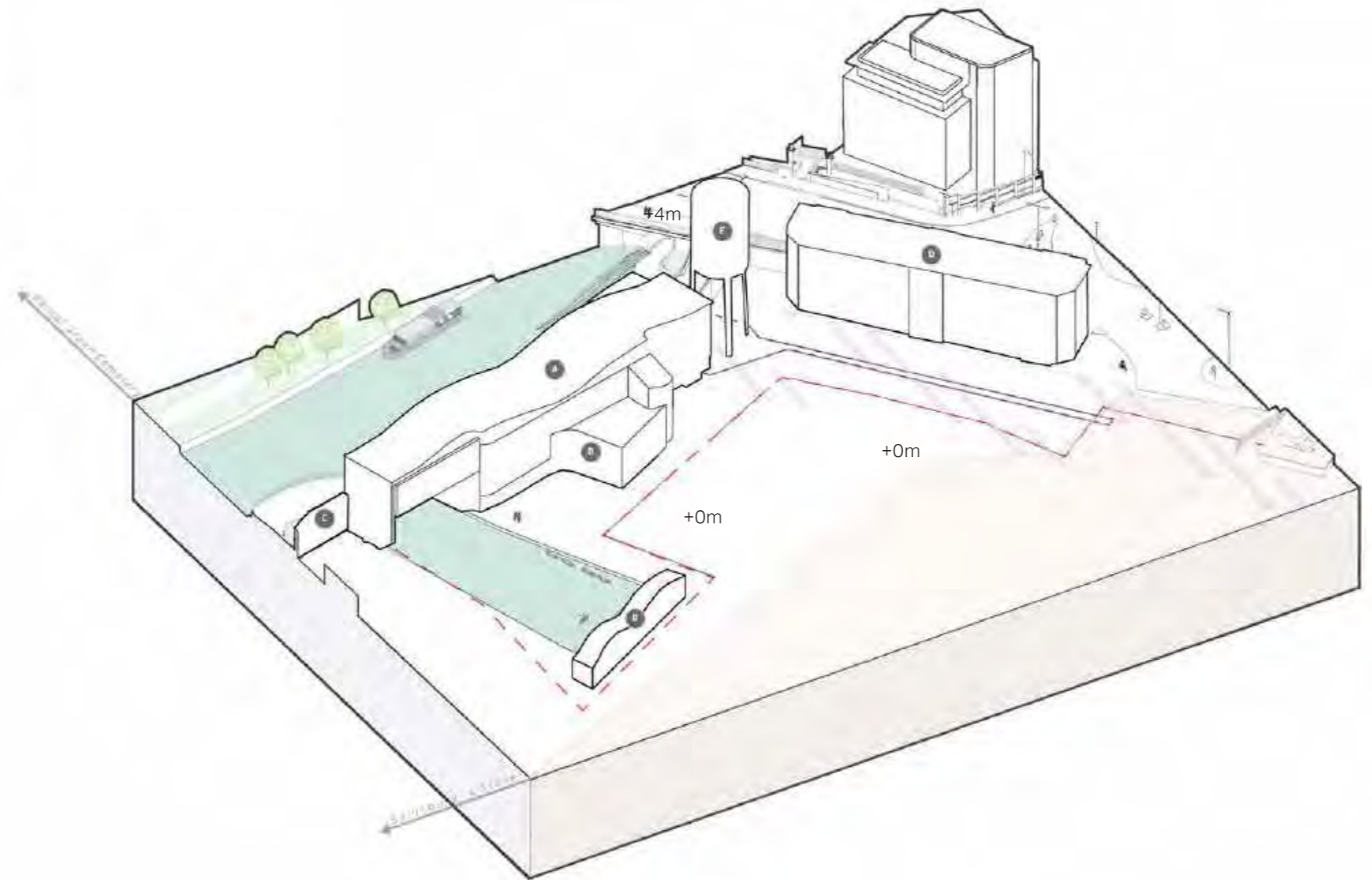

Key

- A Housing (16 Homes)
- B London Sports trust
- C Structural Wall
- D Canalside House
- E Water tower
- - - Gas Lines
- ||||| Gas Lines 10 Meter offset

3.6.4 Boathouse Centre

The Boathouse Centre building is a mixed use building fronting the canal in the north eastern corner of the site.

The building includes 16 social rent homes, currently managed by Peabody, and a small community sports centre, managed by London Sports Trust that runs several sites in West London.

The masterplan proposes to demolish the existing building in order to create space for the proposed new public green space at the entrance of the site.

The existing homes will be reprovided within the new housing blocks on site. The existing sports centre will also be reprovided within the new masterplan. The construction of the new homes and sports facility will be phased to ensure a direct transition from existing accommodation into new.

The existing sports centre is a well used facility, welcoming school groups and local youth groups for sports activities as well as lifeskills lessons. The centre benefits from access to the existing canal basin and provides canoe and kayak sessions on the canal. The centre facilities are cramped and access to the centre is poor with only a narrow spiral stair case or a lift and staircore that is shared with the homes above.

Design proposals for the new facility are included in sections 7.0 and 11.0 of this report.

The 'Manage demolition and construction waste' section of the 'Circular Economy Statement' and the 'Planning Statement' provide further justification for demolition.



Boathouse Centre Level 00 GA Plan

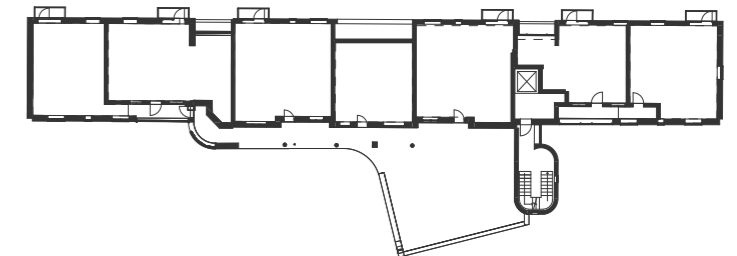

Boathouse Centre Level 02 GA Plan

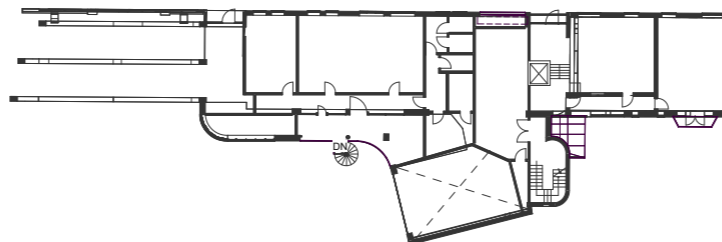

Boathouse Centre Level 01 GA Plan

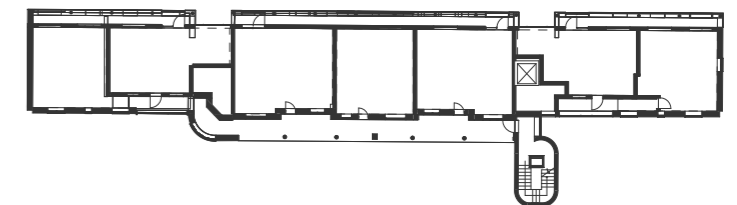

Boathouse Centre Level 03 GA Plan



Fig 3.118: An aerial view of the Boathouse Centre taken in August 2023.

3.6.5 Canalside House

Canalside House was built in 1929 as an office building for the gas works. Its frontage to Ladbroke Grove, was designed in a neo-classical style which was typical for the period.

The value/ sensitivity of Canalside House is considered to be low, however due to the building being one of the last remaining buildings of the gas works site, the building does have some local heritage significance.

The proposed development seeks to demolish the existing building in order to create space for a large public green space at the entrance of the site. This space would be open to existing local residents and visitors, as well as new residents on the site. The proposals for this site are contained within chapter 11 of this report.

The 'Landscape and Public Realm Strategy' which accompanies this application provides concepts for how key elements of the building could be re-used within the Plot 06 park.

As with the Boathouse Centre, the 'Circular Economy Statement' and the 'Planning Statement' provide justification for demolition of the building alongside the section which follows.



Fig 3.120: Extract from 'Landscape and Public Realm Strategy' looking at Canalside House facade re-use.



Fig 3.119: An aerial view of the sites Ladbroke Grove junction taken in August 2023



Fig 3.121: The Ladbroke Grove elevation

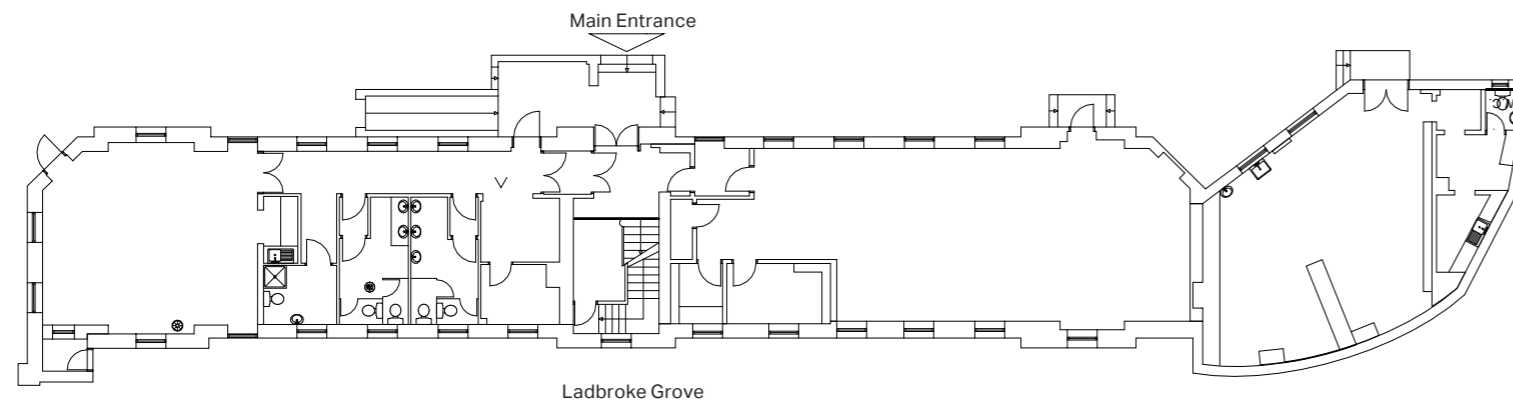

Fig 3.122: Ground level plan

3.6.5.1 The existing building

The existing building is currently owned by RBKC and is occupied by various tenants including charities, community groups, care agencies, housing co-ops and small businesses.

The building has three storeys linked with a single stair, its total internal area is approximately 880sqm. The main entrance is on the western side of the building from the access road that runs north south from Canal Way.

The building has an external escape stair at its north west corner that provides escape from the building into the yard to the west of the building.

The building does not have a lift, and, with internal stairs and steps and narrow door widths, the building does not provide appropriate accessibility. The building also abuts an existing gas line, as shown on the previous page and as such the opportunity to extend is challenged.

The existing building is positioned hard up against the pavement to Ladbroke Grove. At the buildings south east corner, the building sits within 2m of the kerb line, restricting views and access to the site and channeling pedestrians in close proximity to the busy roundabout against the site entrance.



Fig 3.124: The junction between the existing building and the pavement on Ladbroke Grove

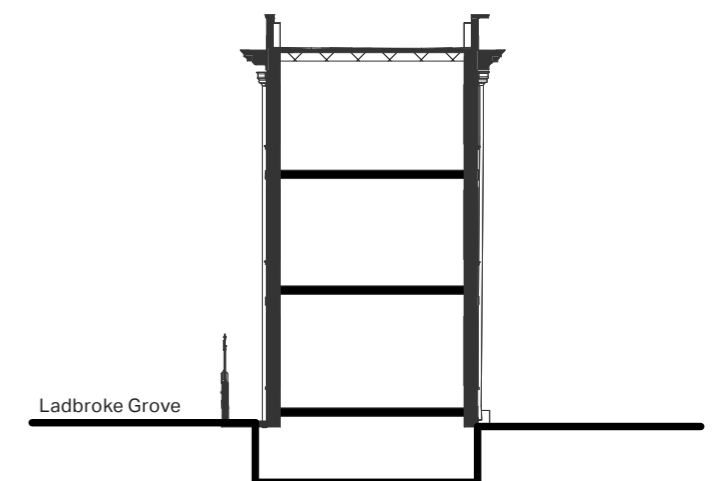

Fig 3.123: Existing building section

3.7 Integrating the Carnival

3.7.1 Existing Condition

Notting Hill Carnival takes place each year in August and sets up in 4 main locations across the borough of Kensington and Chelsea. One of which is within the site boundary. The Mastermind Soundstage is within the proposed site boundary, adjacent to Canalside House and the Water Tower, as shown below and marked with a star on the map. The carnival route runs in a circuit along Ladbrooke Grove and through Kensal Town, passing a range of soundstages enroute as shown by the red line. Traders set up along the blue highlighted routes and these in turn are framed by soundstages. The applicant team have held a number of meetings with the carnival organisers to brief them on the emerging proposals.



Fig 3.126: Notting Hill Carnival Mastermind soundstage adjacent Canalside House

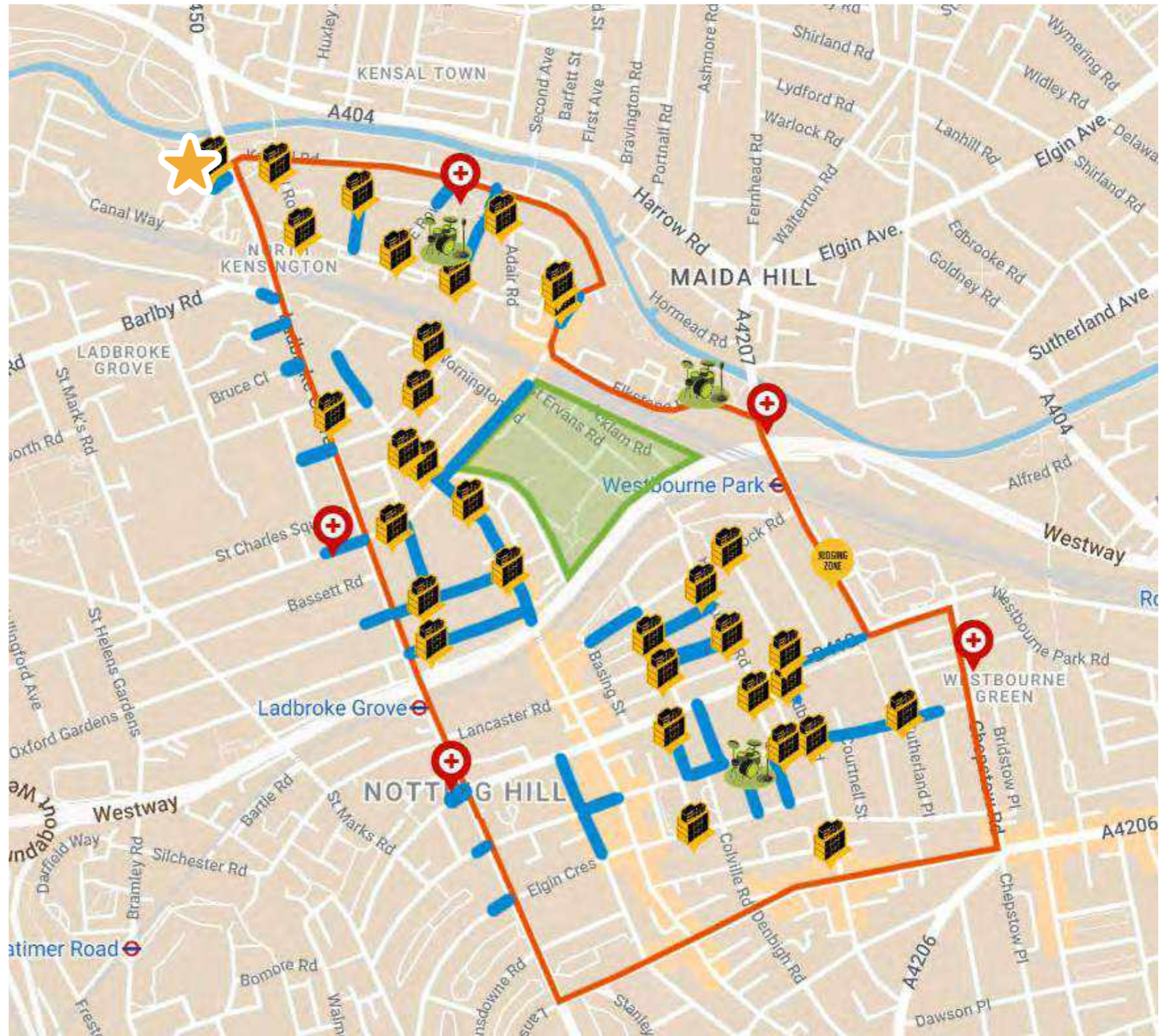

Fig 3.125: Notting Hill Carnival 2023 Route Map

3.7.2 Proposed Condition

The proposal includes a new public space within Plot 06, known as Ladbroke Gardens. This space would be publicly accessible throughout the year but it is envisaged that it would provide the necessary area for an events space and soundstage when the carnival was operating. In addition, the network of streets within the masterplan could provide areas for the carnival to set up, in a similar manner to the existing condition. Discussion with the carnival organisers is ongoing and will continue beyond the application process.



Fig 3.128: Illustrative proposal for one of the carnival soundstages within Plot 06 garden



Fig 3.127: Illustrative proposal for one of the carnival soundstages within Plot 06 garden

3.8 New Neighbourhood Centre

3.8.1 Overview

The retail and commercial strategy has been developed in close collaboration with Churchill & Partners and has been built upon the principles set out within the SPD, as outlined in Chapter 4 (The Process) of this report.

The majority of the commercial areas (excluding the proposed Sainsbury's Store) are being applied for in outline. As such, the distribution of the commercial units is conveyed through the parameter plans submitted with the application. The drawing below is an illustration to convey the potential layout of certain uses within the masterplan. This strategy will be

developed further once each plot is brought forward in detail and tenants are secured.

The distribution of units follows the principle of a vibrant and active eastern half of the masterplan, and a calmer, residentially focussed western half. The eastern half would contain a predominance of

community uses, such as bars, bistros, workshops, restaurants and retail uses, gathered around the high street (known as 'The Avenue'). The existing basin will be activated with a new sports building, to replace the existing boat club. The new Sainsbury's Store front acts as a destination at the western end of this street.



Fig 3.129: Indicative retail uses across the masterplan

3.9 The Landscape Masterplan

3.9.1 Overview

The landscape proposals are comprised of elements to be delivered in both detail and in outline. This distinction can be seen in the drawing opposite and is also contained on the landscape drawings which also form part of the planning application. Full details of the landscaping strategy are provided in the 'Landscape and Public Realm Strategy' document (167-SPA001-X-XX-DC-L-RP-0001) which conveys the approach across the whole masterplan.

In addition to this, the 'Design Code' provides the rules and recommendations which govern the landscape design across the outline elements of the scheme. This document has also been provided within the planning application.



Key:



Element of the landscape and road network being applied for in Detail. All other areas of landscape within the Application Site are being applied for in Outline

Fig 3.130: Illustrative masterplan drawing - showing the split between the outline and detailed landscape proposals

4.0 The Process

4.1	Introduction	107	4.6.4	Hutchinson and Partners	141
4.1.1	Section Overview	107	4.6.5	Maccreeanor Lavington	142
			4.6.6	Spacehub	143
4.2	Design Evolution	108			
4.1.2	Masterplan Evolution	108			
4.2.1	Massing Evolution	111			
4.3	Locating the Store - Design Evolution	113			
4.4	Supplementary Planning Document	118			
4.4.1	Overview	118			
4.4.2	Appraisal against the SPD	118			
4.4.3	B:6 Character	124			
4.5	QRP Feedback	128			
4.5.1	The Quality Review Panel	128			
4.5.2	QRP Formal Response	128			
4.6	The Design Teams	138			
4.6.1	Architect Distribution	138			
4.6.2	Planning Structure	139			
4.6.3	The Masterplan Architects	140			



The Golden Mug

Bakecrafty

Emporium

Coffee

Bakecrafty

4.1 Introduction

4.1.1 Section Overview

This section has been compiled to provide a summary of the evolution of the masterplan since 2020, when pre-application consultation with planning officers within the Royal Borough of Kensington and Chelsea (RBKC) began.

The section explains some of the key planning and massing developments made during this time and illustrates some of the Plot 02 (the new Sainsbury's Store) layout configurations which have been tested.

The Supplementary Planning Document (SPD) produced by RBKC for the site has been an important reference as the scheme has developed. The overall site capacity, massing response, and character has been driven by the core principles of this document. Section 4.4 has been written to illustrate how this has been achieved within the proposals.

Section 4.5 focuses on meetings and advice received from the Quality Review Panel. The Quality Review Panel provides expert advice to applicants, council officers and the planning committee during the pre-application process, and by commenting on planning applications. Within this section we have reflected upon the advice given and have illustrated the implications of the key points raised.

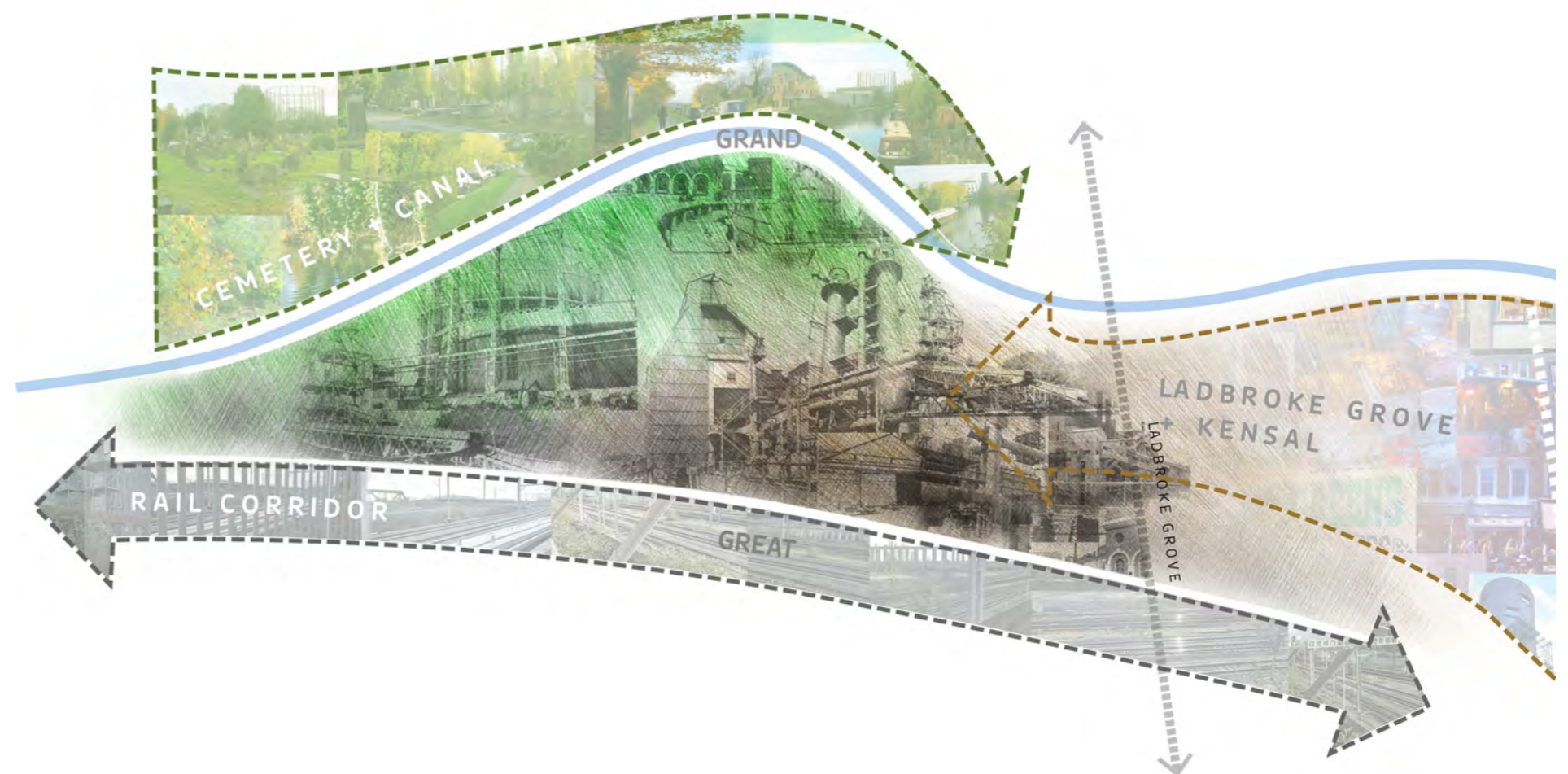

Fig 4.1: Key Masterplan Concepts

4.2 Design Evolution



Fig 4.2: Base Masterplan - June 2020

The feasibility masterplan prepared by FaulknerBrowns in June 2020.

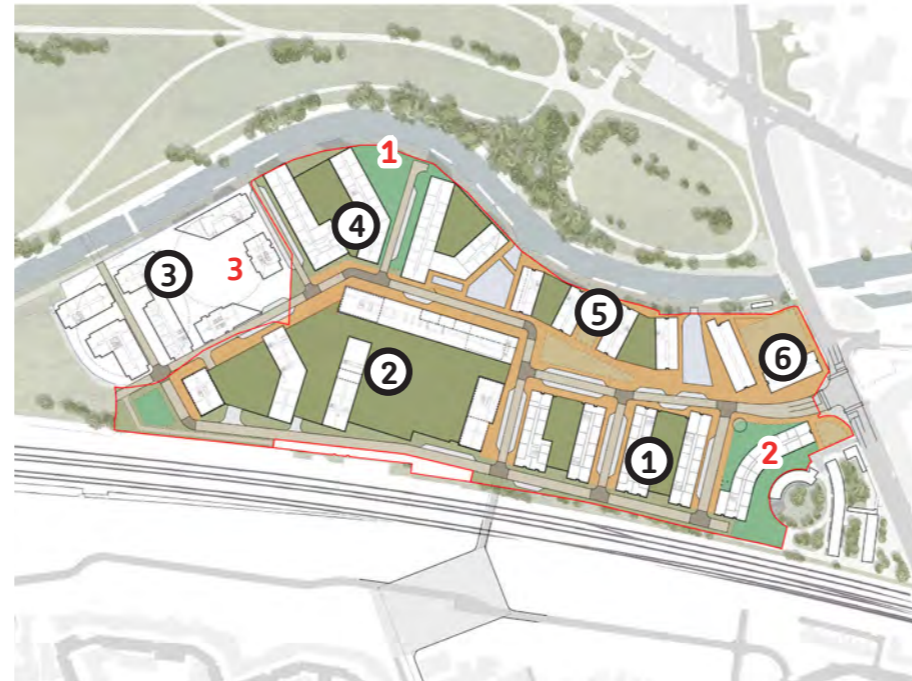

Fig 4.3: Base Masterplan - January 12th 2021 - Pre App Meeting 01

1. Reconfigured Plot 04 garden
2. Crescent shaped building to Plot 01 to better respond to Kensal House
3. Integration of Berkeley St William Plot 03 building footprints.

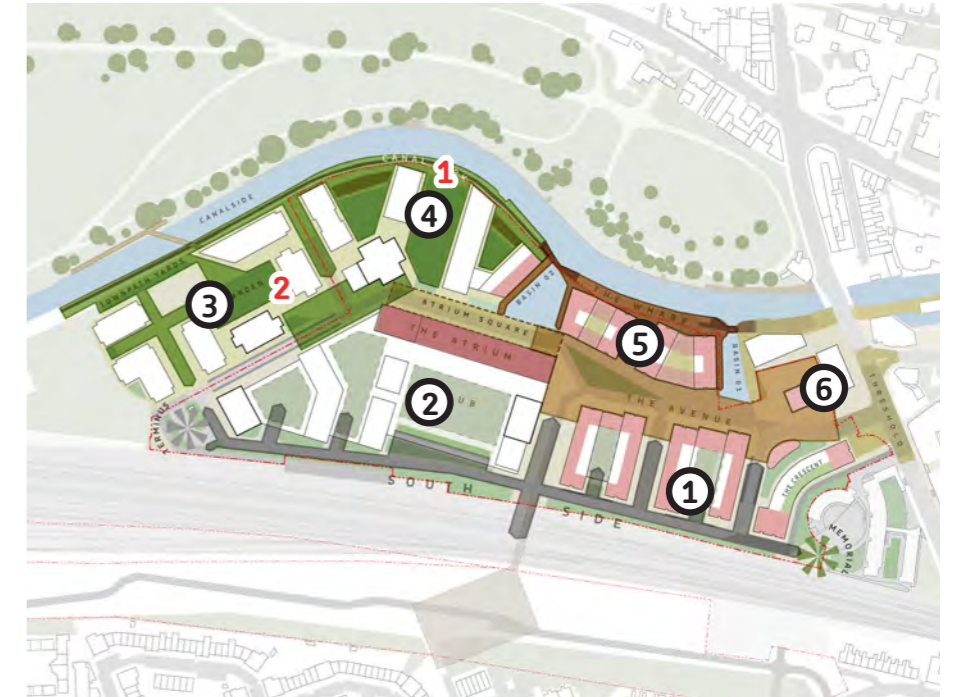

Fig 4.4: Base Masterplan - 23rd March 2021 - Pre App Meeting - Movement Strategy

1. Reconfigured Plot 04 garden
2. Update to Berkeley St William Plot 03 building footprints.

4.1.2 Masterplan Evolution

This section describes the evolution of the masterplan ground plane drawing. Each plan represents the configuration as presented during meetings held with RBKC during our pre-application discussions. Although Plot 03 is not a part of this application and is owned by Berkeley St William, we have worked closely with their team to ensure alignment with the wider masterplan. As such, Plot 03 design iterations are also shown here.

In our early discussions with RBKC planning officers in early 2021 it was apparent that we would need to exclude RBKC land from our proposals, and as such Plot 06 became a point tower, adjacent the retained Canalside House and the Boathouse Centre.

As discussions progressed with RBKC it became feasible for Ballymore and Sainsbury's to acquire the portion of RBKC land which contains the existing basin, Canalside House and the Boathouse Centre. As explored in Section 3, the case for their removal was strong, given that this would provide the opportunity for a new public park at the threshold to the site whilst also providing modern homes and facilities for both the existing residents and tenants.

- ① Plot reference
1. Amendment annotation

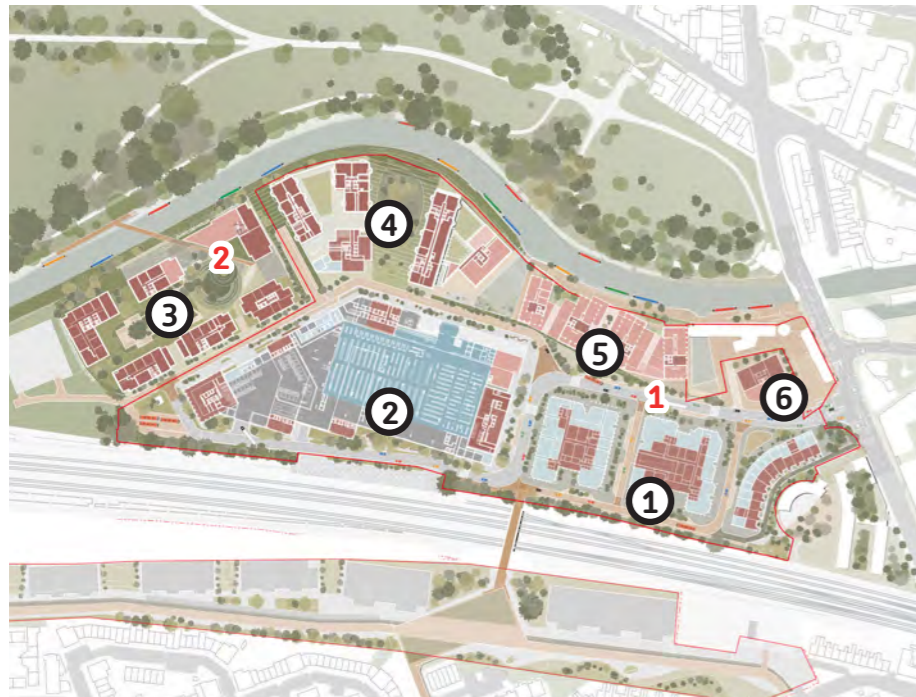

Fig 4.5: Base Masterplan - 13th April 2021 - Pre App Meeting - Joint Landowners Meeting

1. Update to movement strategy to include primary traffic route through the central high street.
2. Reconfigured Plot 03 building footprints.

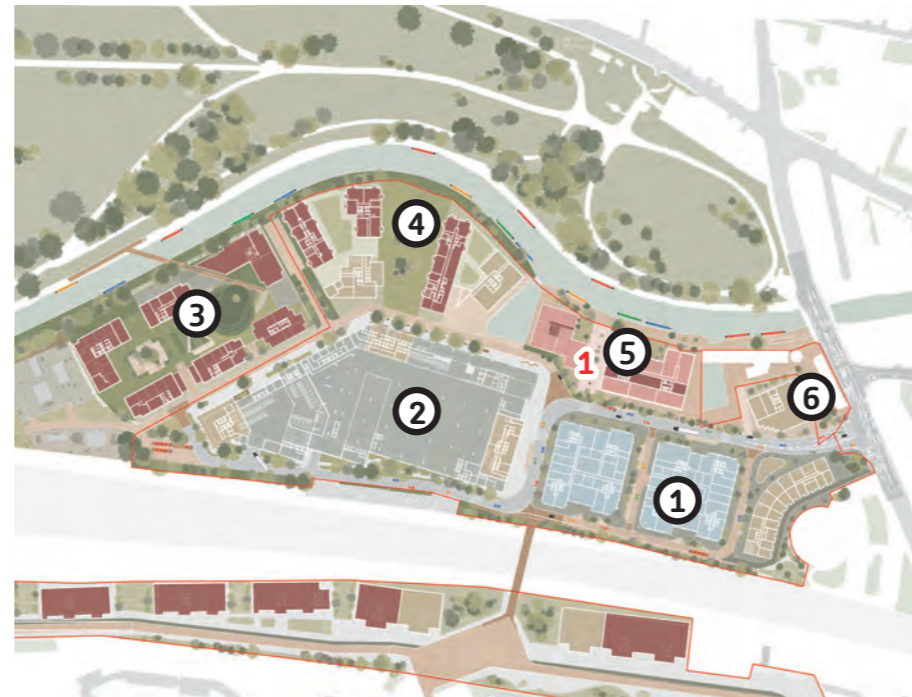

Fig 4.6: Base Masterplan - 5th July 2021 - Pre App Meeting - Height and Massing

1. A re configuration of Plot 05 to introduce a central (lane way) to connect to the canal towpath.

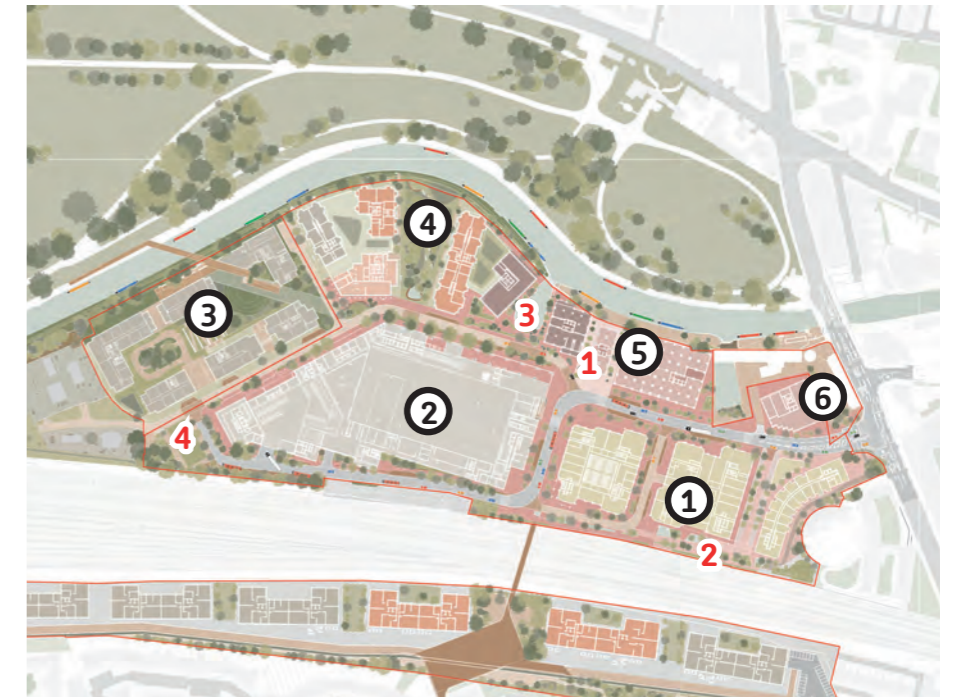

Fig 4.7: Base Masterplan - 19th August 2021 - Pre App Meeting - Plot 01 Review

1. A re configuration of Plot 05 to introduce 2no. pedestrian lane ways and a pavilion building.
2. The introduction of the linear park to Plot 01 and the re-routing of buses to the central lane of Plot 01.
3. Development of the landscape to the reclaimed basin.
4. Introduction of the MUGA and active landscape at South West corner of Plot 02.

- ① Plot reference
- 1. Amendment annotation

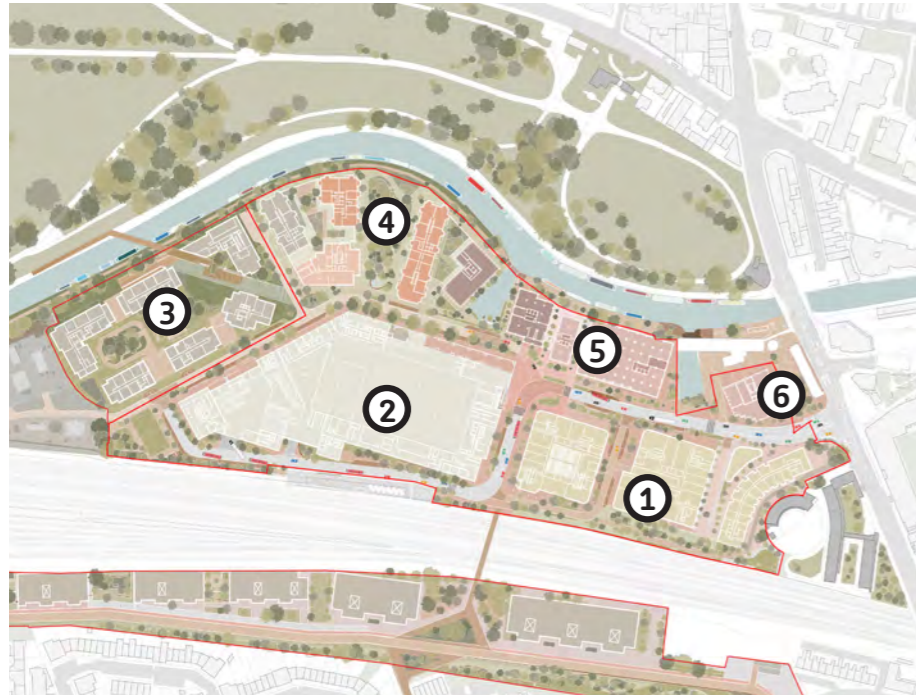

Fig 4.8: Base Masterplan - 4th October 2021 - Pre App Meeting - Sustainability Approach

Design evolution and integration of building and landscape designs.

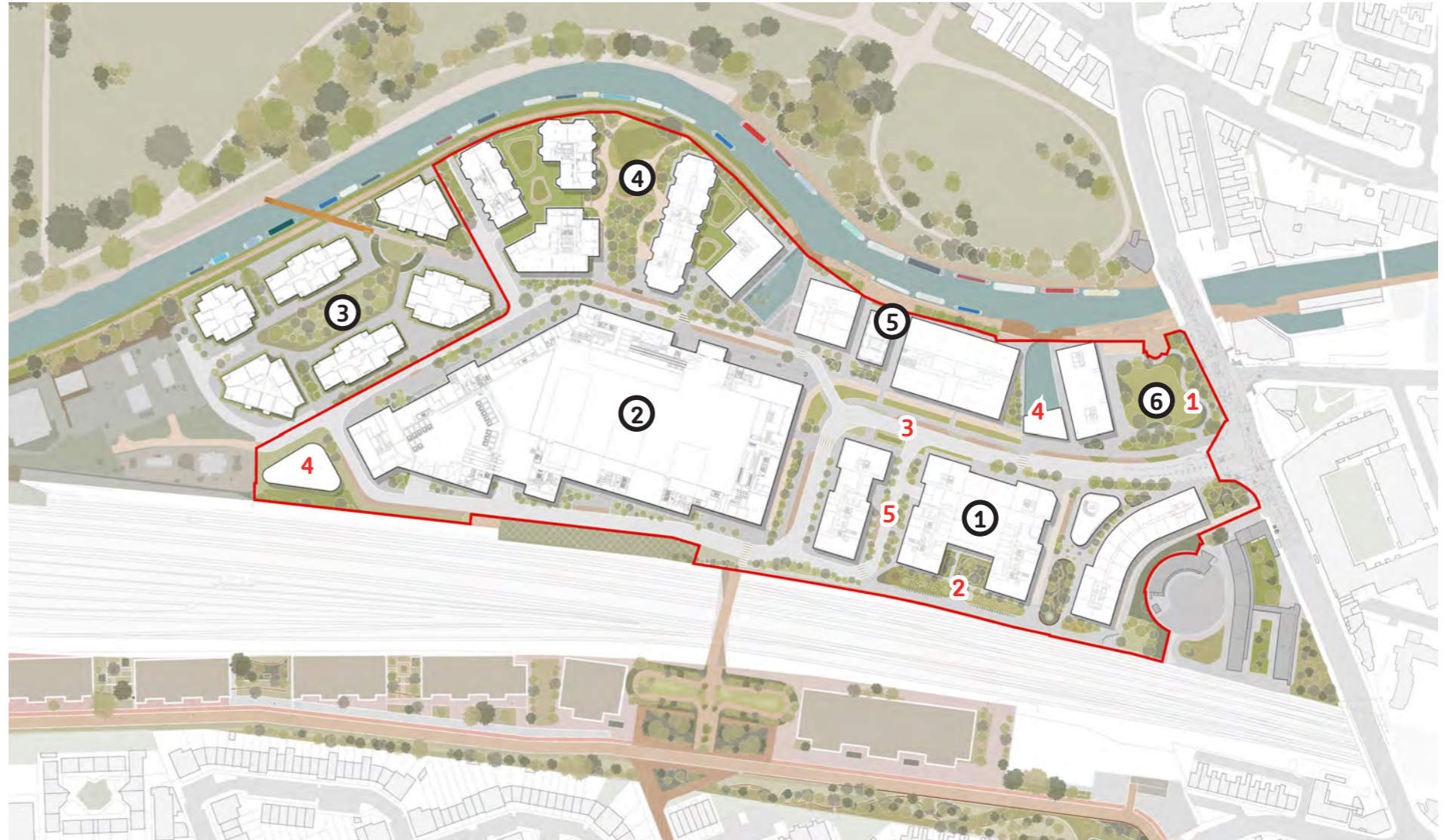

Fig 4.9: Base Masterplan - Summer 2023 - Planning Application

Figure Ground Design Updates

1. Plot 06 included within the red line planning application boundary. The design developed to include a public green space.
2. The southern terrace developed to show a shared public garden and play space.
3. The central avenue amended to show more trees and green landscape with the road moved south within the space.
4. A sports pavilion (as part of the London Sports Trust offer) shown to the existing canal basin and the south west corner of plot 02.
5. Plot 01 figure ground layout amended to show 4 blocks as opposed to 5. This has resulted in wider pavements, greater spaces between buildings and more public space/landscape.

- ① Plot reference
- 1. Amendment annotation

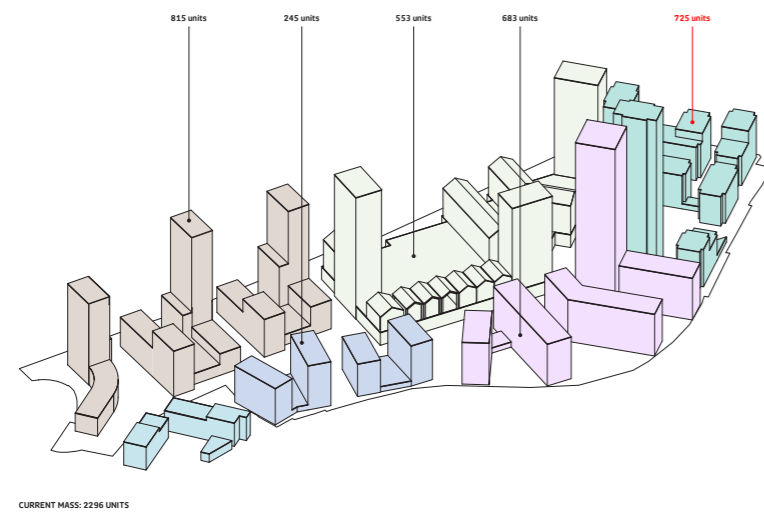

Fig 4.10: Massing - 1st December 2020

Base massing position.



Fig 4.11: Massing - February 9th 2021 - Joint Landowners

Curated massing approach.

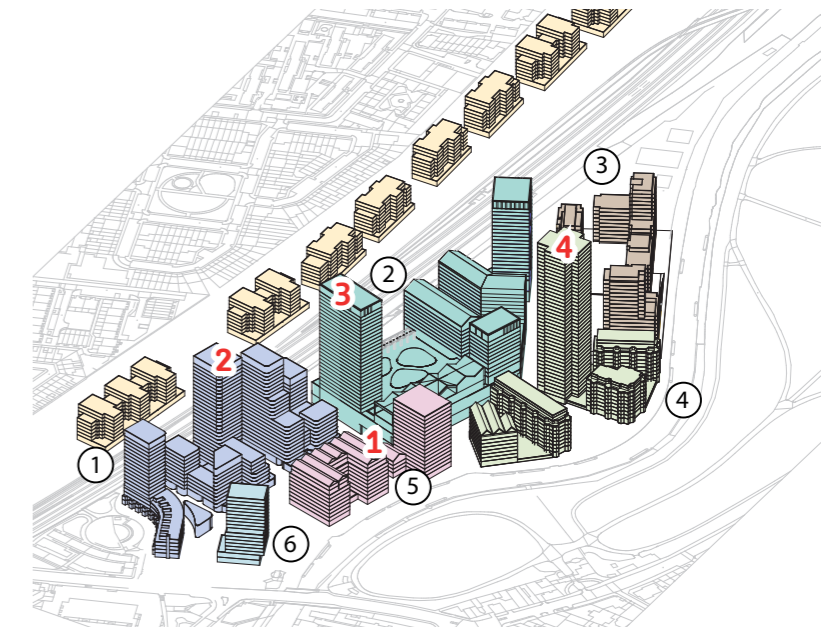

Fig 4.12: Massing - 19th May 2021 - Pre App Meeting - Movement Strategy

1. Reconfigured mass to Plot 05, a larger format 11 storey block with a marker building to the reclaimed basin of 14 storeys.
2. Taller marker block within Plot 01.
3. High street and store marker building at 30 stories.
4. Fulcrum building at 40 storeys.

- ① Plot reference
- 1. Amendment annotation

4.2.1 Massing Evolution

The following diagrams describe the evolution of the massing proposed for the site. Each diagram represents the configuration as presented during meetings held with RBKC during our pre-application discussions.

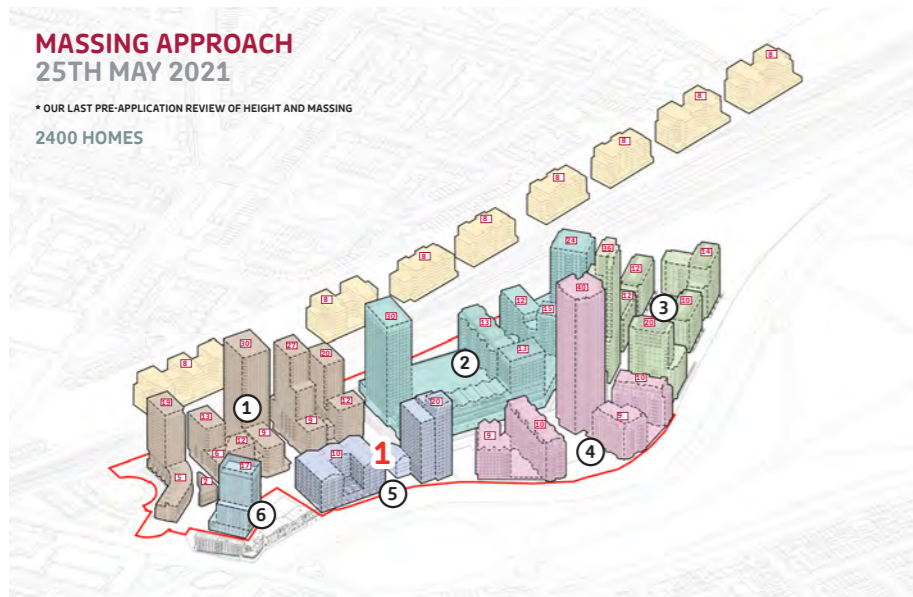

Fig 4.13: Massing - May 25th 2021 - Pre App - Height and Massing

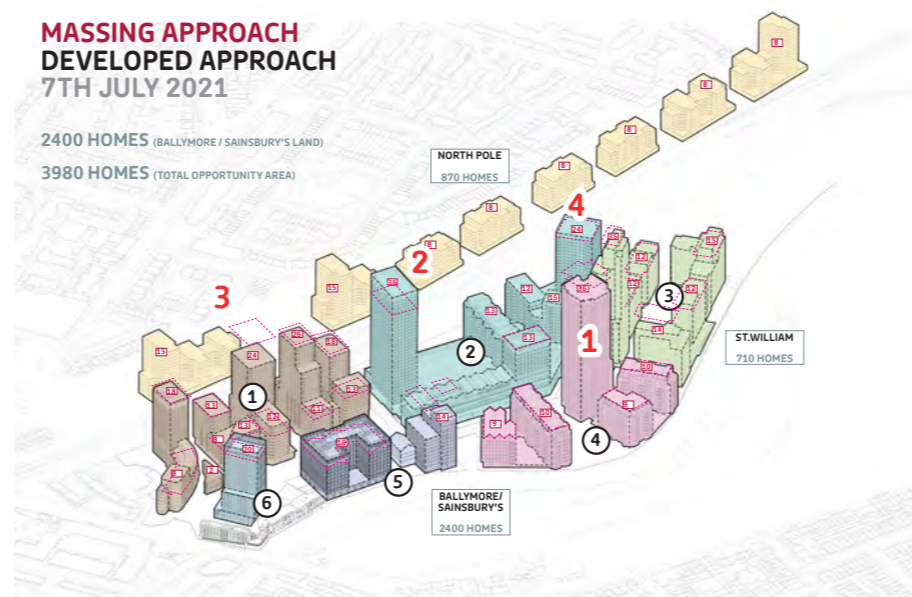

Fig 4.14: Massing - 7th July 2021 - Pre App - Height and Massing



- 1. Reconfigured mass to Plot 05, a pavilion building added to the centre of the plan.

- 1. Fulcrum building mass reduced from 40 - 36
- 2. High Street and store marker building increased from 30-36.
- 3. Taller buildings in plot 01 reduced in height, lower 'shoulder blocks elements increased in height.
- 4. South Western tower of plot 02 reduced to 24 storeys.
- 5. Plot 01 train line facing building heights modified to 20 and 24 storeys.
- 6. Plot 05 reclaimed basin marker increased in height to 20 storeys.

- ① Plot reference
- 1. Amendment annotation



Fig 4.15: Massing - Summer 2023

4.3 Locating the Store - Design Evolution

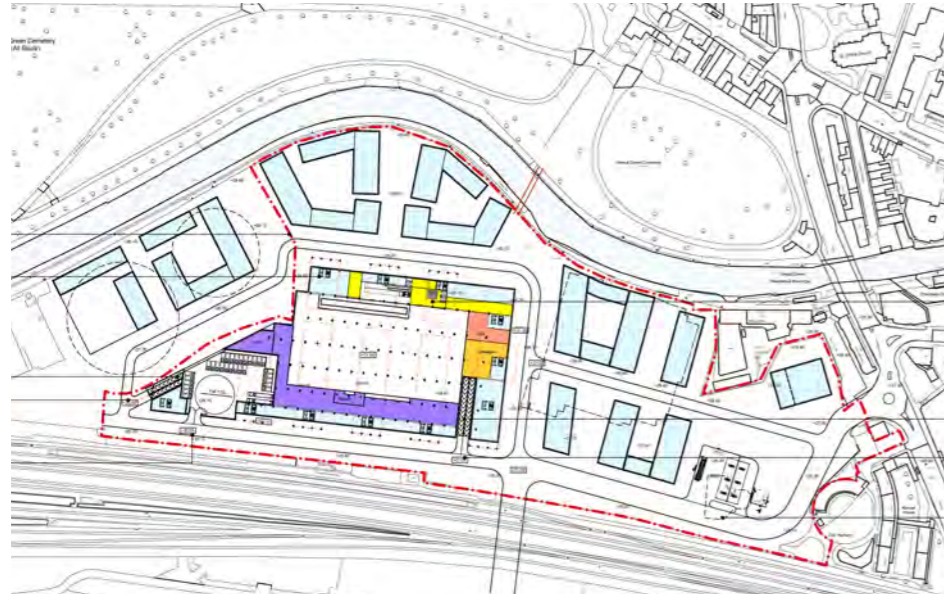

01 Store to West of Site, facing the canal, February 2017

Study 01 illustrates the size of the store and the residential accommodation lining the perimeter make it difficult to develop the remaining site to the north and west of the store. Visibility to the west of the site is also compromised.



02 Store to West of Site, facing Ladbroke Grove, February 2017

Study 02, rotating the store exacerbates the issues identified in Study 01 as well as compromising access to the west. In Study 03, the store blocks visibility to the western side of the site and compromises access from Ladbroke Grove to the rear of the site. The appearance of the store also dominates.

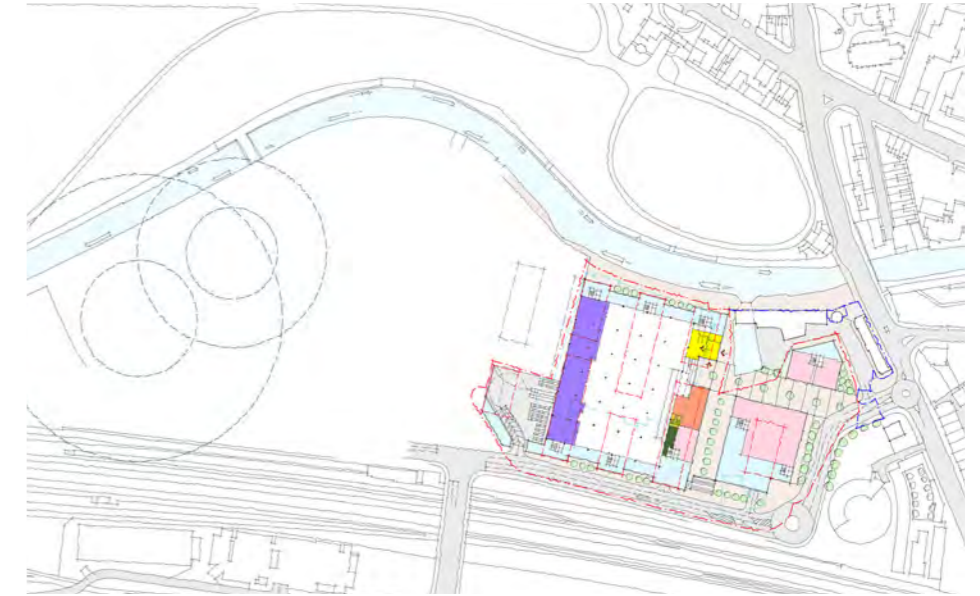

03 Store to East of Site, facing Ladbroke Grove, September 2017

Study 03, would result in the demolition of the existing store and a resultant loss of trade. The suggested store position would also significantly congest the layout of the eastern portion of the site and impact on traffic movement options and the location of the neighbourhood centre.

4.3.1.1 Evolution of Plot 02 - Locating the Store

The location and size of store has a significant impact on the overall masterplan and potential opportunities throughout the site. Numerous studies have been carried out to test the advantages and disadvantage of each location, summarised in the studies above.

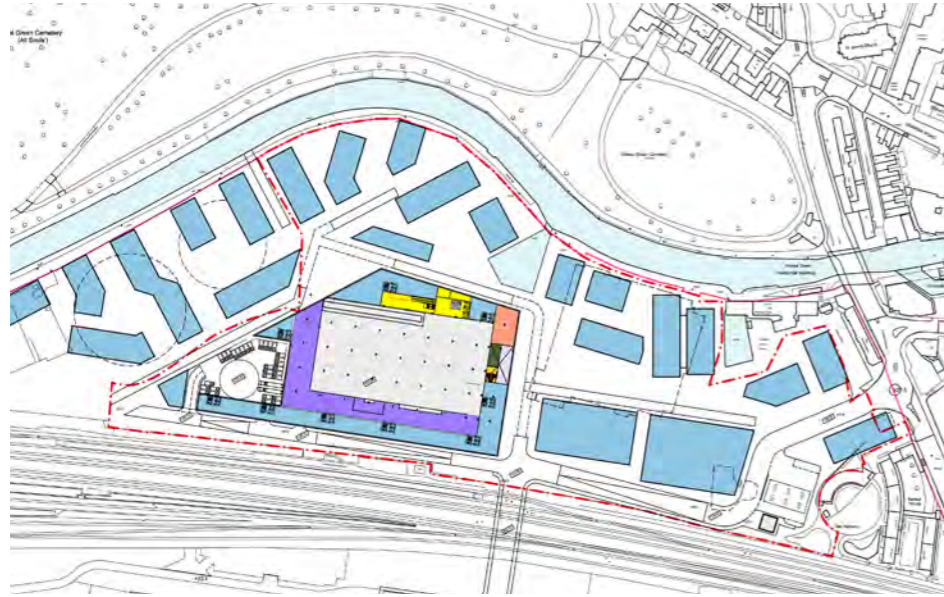

04 Initial Masterplan by FaulknerBrowns, December 2017



05 Stage 01 Masterplan, May 2018



06 Stage 02 Masterplan, October 2018

4.3.1.2 Evolution of Plot 02 - Locating the Store

The location and size of store has a significant impact on the overall masterplan and potential opportunities throughout the site. Numerous studies have been carried out to test the advantages and disadvantage of each location, summarised in the studies above.

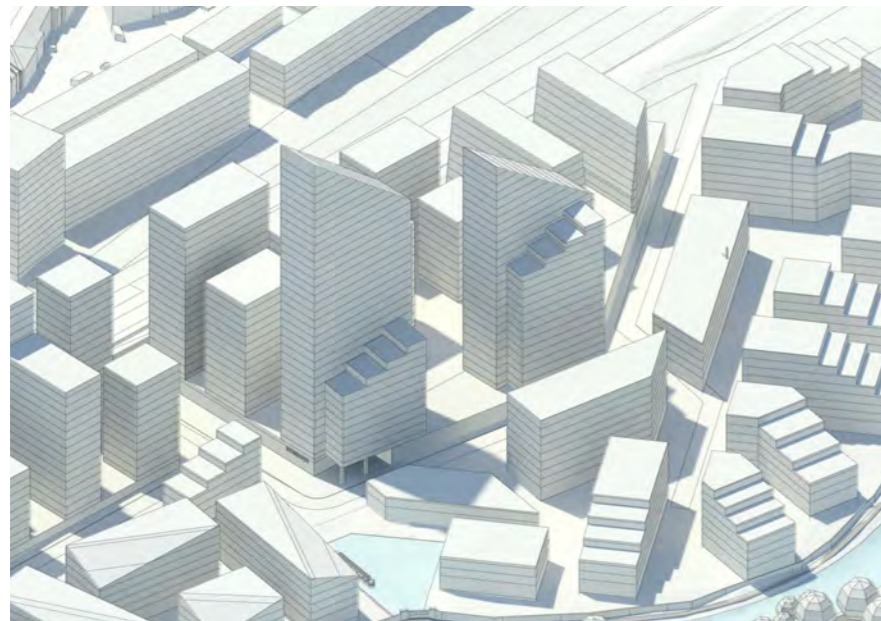

01 Original Masterplan Proposal by FaulknerBrowns

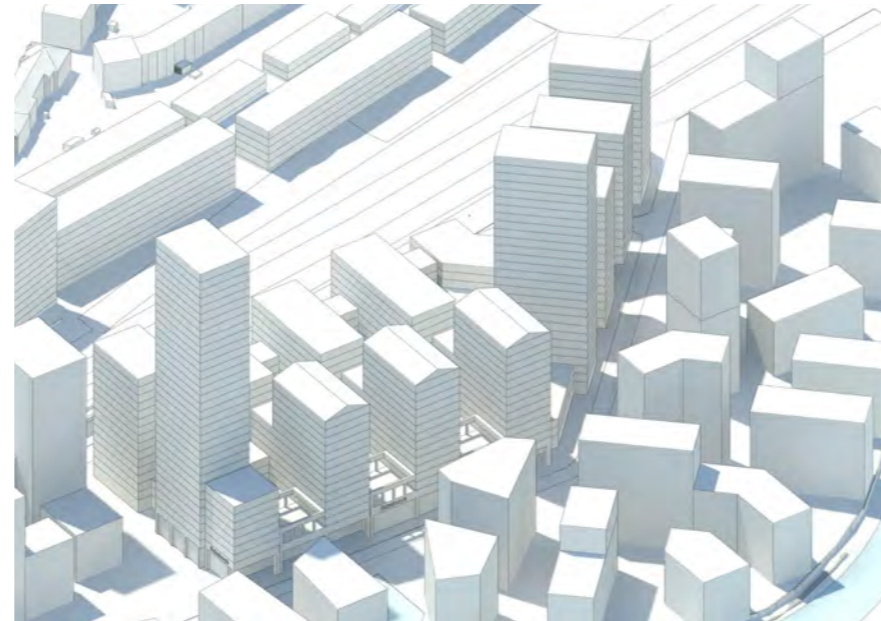

02 High Density Proposal

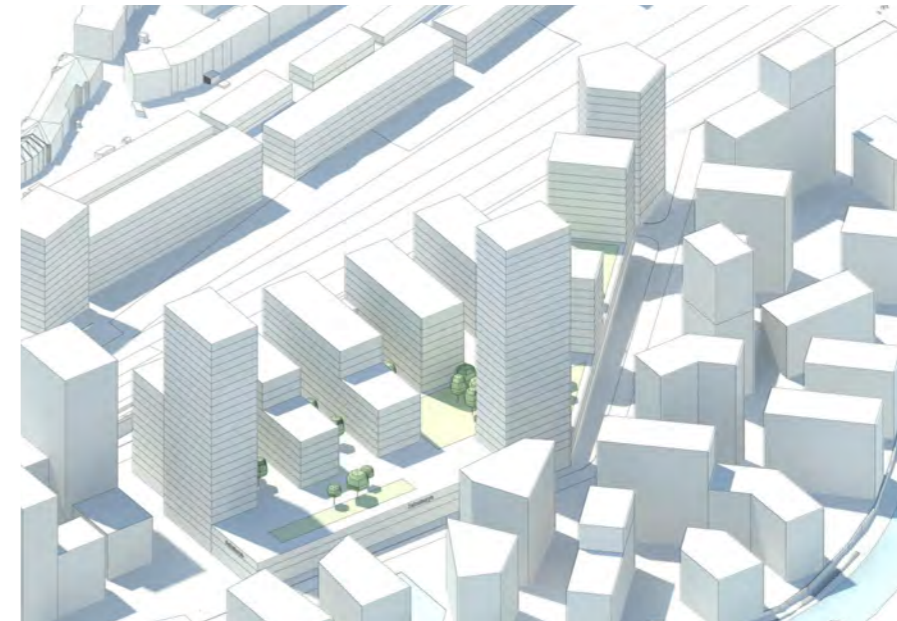

03 Proposal by FaulknerBrowns with no Built Form to the North

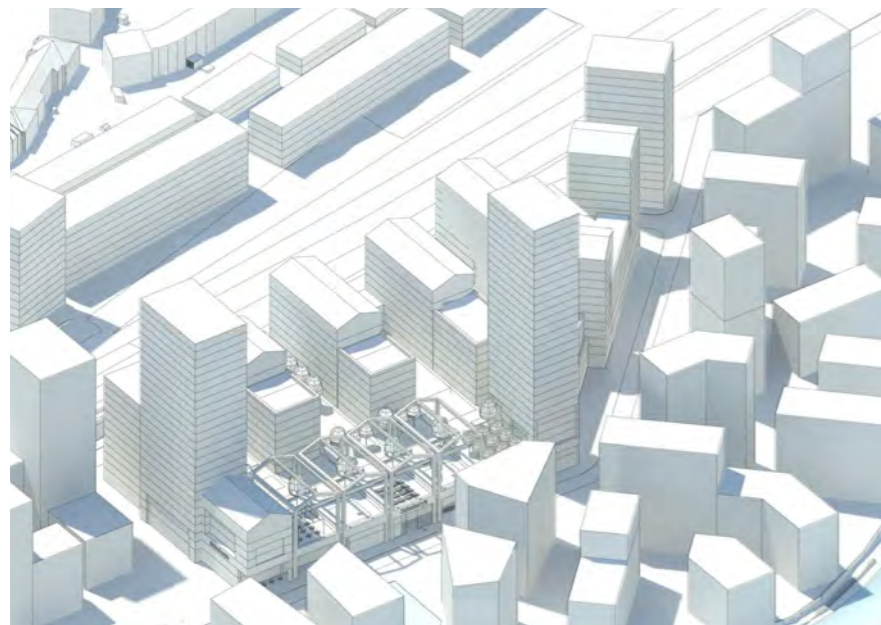

04 H&P Proposal with Amenity Building & Frames to Northern Edge

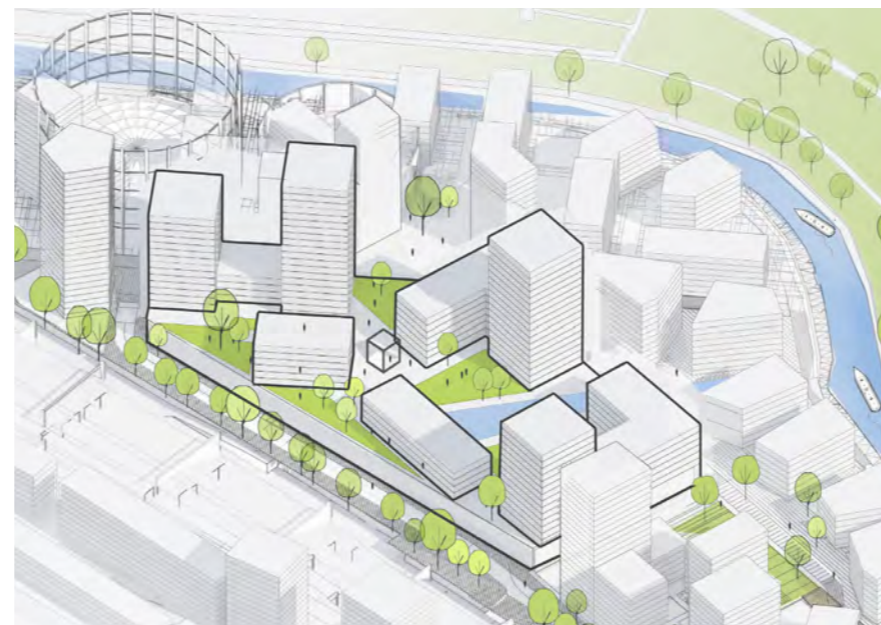

05 Proposals by KPF

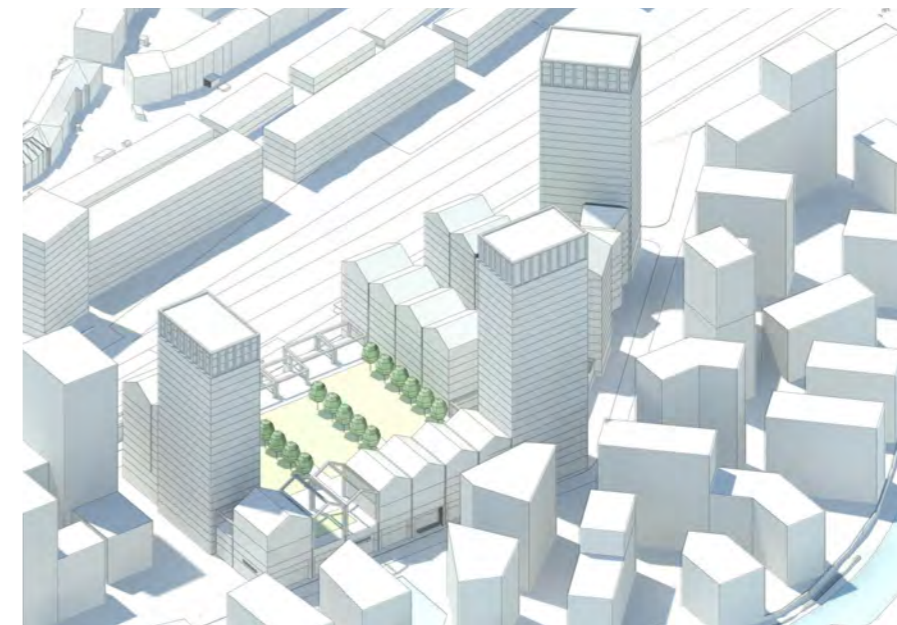

06 H&P Proposal incorporating Taller Buildings

4.3.1.3 Evolution of Plot 02 - Form and Density

Concept design studies have been carried out by a number of architectural practices exploring the overall form and density of the proposals on Plot 02. The studies above illustrate the range of concepts tested, varying in number of buildings, height, extent of landscaping. The initial concept designs highlight viability issues such as buildability above the store, provision of amenity space, aspect, and the quality of daylight/sunlight to dwellings.

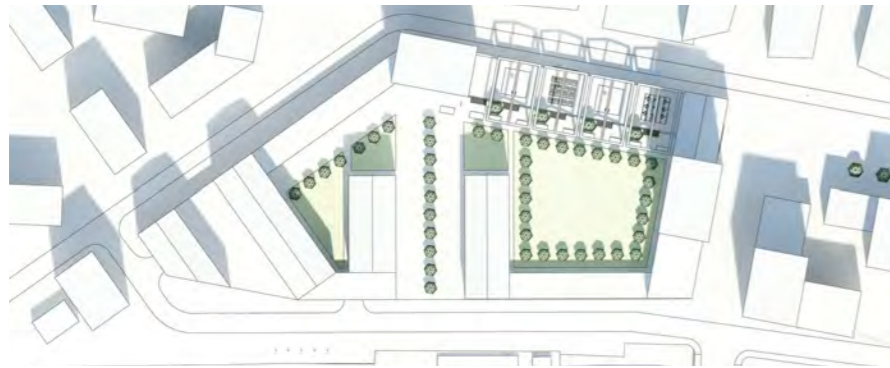

Configuration 01



Configuration 02



Configuration 03



Configuration 04



Configuration 05



Configuration 06



Configuration 07



Configuration 08



Configuration 09



4.3.1.4 Evolution of Plot 02 - Configuration

The form and density illustrated in Study 06 on the previous page presents the most viable location for the store, with opportunities for taller buildings, active frontages to the perimeter, and good access and visibility to the remainder of the site. The studies outlined above provide an overview of the various configurations of the residential buildings tested above the store. These studies begin to focus on the quality of the proposed dwellings, including orientation, aspect, views, number of dwellings per core, access to amenity space, quality of daylight and sunlight, as well as testing the structural constraints in relation to the store below.

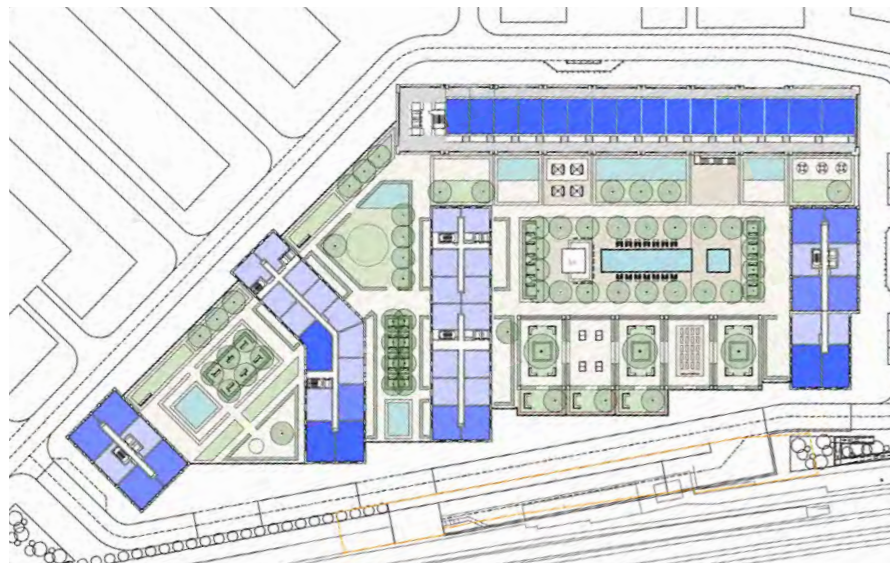

01 Additional Dwellings to Northern Edge above Amenity Building

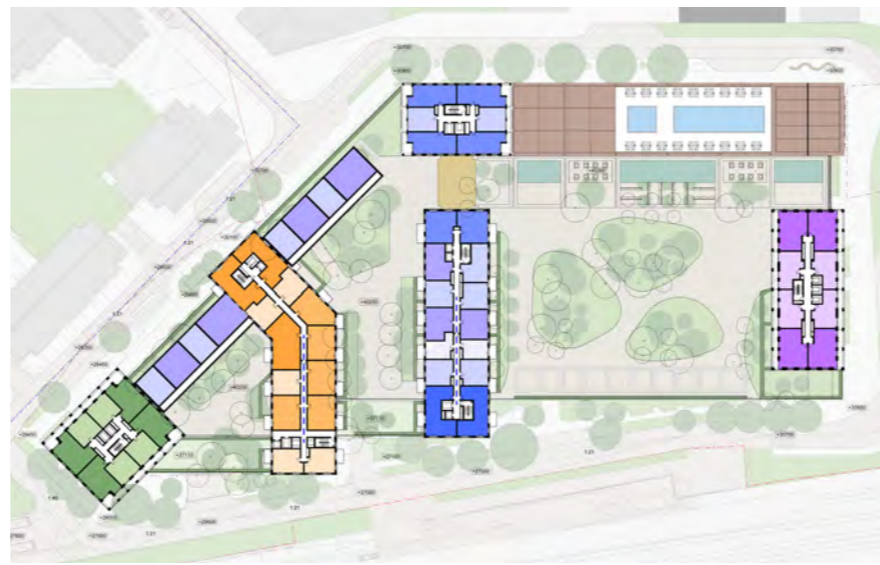

02 Additional Dwellings to North Western Edge

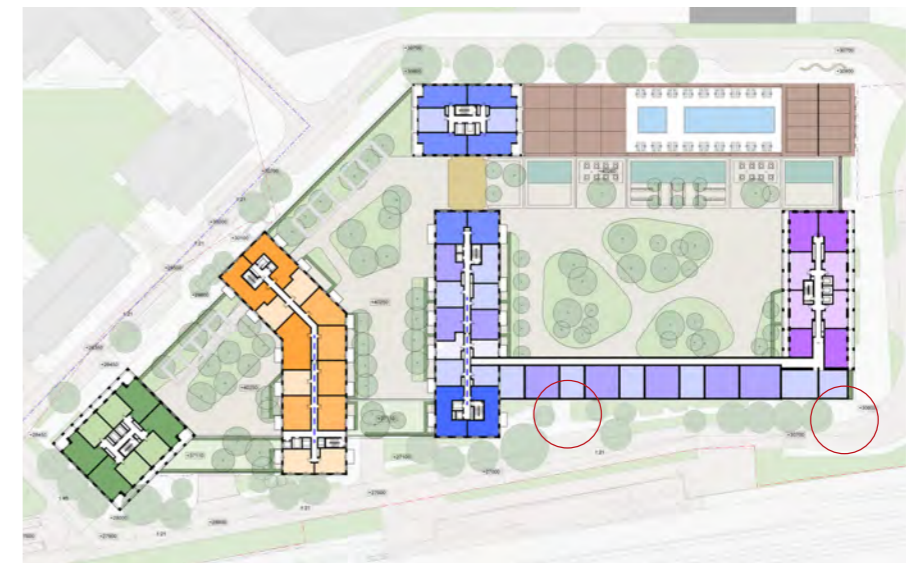

03 Additional Dwellings to Southern Edge

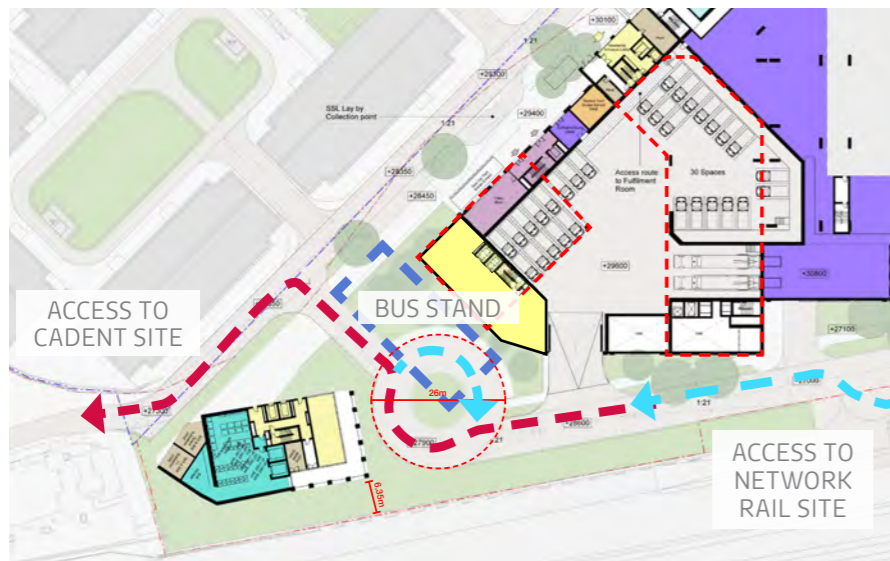

04 Disconnecting Building on Western Edge of Site



05 One Additional Linear Residential Building above Store



06 Two Additional Linear Residential Buildings above Store

4.3.1.5 Evolution of Plot 02 - Design testing with RBKC

The illustrations above provide an overview of further design testing carried out in response to comments raised during the pre-planning discussions with RBKC. Each study seeks to increase the density and number of new dwellings on the plot. Additional costs associated with having to build additional podium buildings, basement for cycle store and bike lifts in addition to lifetime management/service costs of cross podium refuse management makes this proposal unviable before

even considering the other impacts it would have on the wellbeing of all residents. This would include loss of site wide community garden amenity, the diminished residential quality, diminished values and the compromised placemaking aspirations. The most significant issue with cross podium only access is the issues of fire fighting access and egress which is strongly discouraged by the Fire Service.



4.4 Supplementary Planning Document

4.4.1 Overview

As described in earlier in the chapter; RBKC has prepared the Kensal Canalside Opportunity Area Supplementary Planning Document (SPD) to provide additional guidance of their expectations for the development of the Opportunity Area as a whole. The SPD requires landowners to work collaboratively with the Council, local businesses and residents to bring forward comprehensive development of the Opportunity Area and is a material planning consideration in the assessment of any scheme within the Kensal Canalside Opportunity Area.

The SPD reiterates the Site Allocation requirements from the adopted Local Plan, such as the provision of a minimum of 3,500 new homes, 2,000 sqm non-residential floorspace and 10,000 sqm of commercial space across the Opportunity Area.

This section appraises the SPD expectations against what the proposed development and focuses on 'Chapter B' as this contains the 'Development Framework' section. The SPD sub-headings have been used throughout this section to provide clarity.

4.4.2 Appraisal against the SPD

Chapter B of the SPD is comprised of the following sections, as discussed, this section uses these as sub-heading throughout:

- B:3 - Connections
- B:4 - Streets and Spaces
- B:5 - Live, Work and Visit
- B:6 - Character



Fig 4.16: Front cover of Kensal Canalside Opportunity Area SPD

4.4.2.1 Appraisal of B:3 - Connections

The chapter is comprised of 3 sub-sections which include the cycle and pedestrian movement strategy, the public transport network and road access.

4.4.2.2 B3.1 Walking and Cycling Network.

The routes indicated within the SPD have been embedded within the masterplan structure. Wide pedestrian footpaths have been provided throughout, typically between 3 and 4.5m in width providing adequate space for cyclists and pedestrians.

A vehicle free route through the Plot 1 garden has been provided for pedestrians and cyclists which connects the potential railway bridge with the site entrance. Routes between buildings on the northern edge of the masterplan provide connections through to the existing canal towpath. A second potential bridge which crosses the canal has also been safeguarded within the proposals and a direct route from Plot 4.1 guides the way to the bridge landing position.

The masterplan provides a dedicated cycle route within the public realm from the site entrance at Ladbroke Grove to the Sainsbury's Store entrance and south to connect with the potential bridge crossing the railway line, as shown on the diagram opposite. This dedicated route is intended to relieve some of the cycle traffic on the towpath as identified in the SPD.

Crossing points to allow the roads to be easily navigated by pedestrians and cyclists have also been provided throughout.

All buildings contain the necessary basement provision for standard, accessible and cargo cycle parking in line with local policy.

Links to the wider cycle network have been provided to and from the new Ladbroke Grove junction, the development will also work with TFL to provide new cycle docking stations as part of the city wide cycle hire network.

The SPD states that the canal and railway bridges are a requirement of the development and Ballymore/ Sainsbury's will work with the Council and other landowners in securing their delivery.

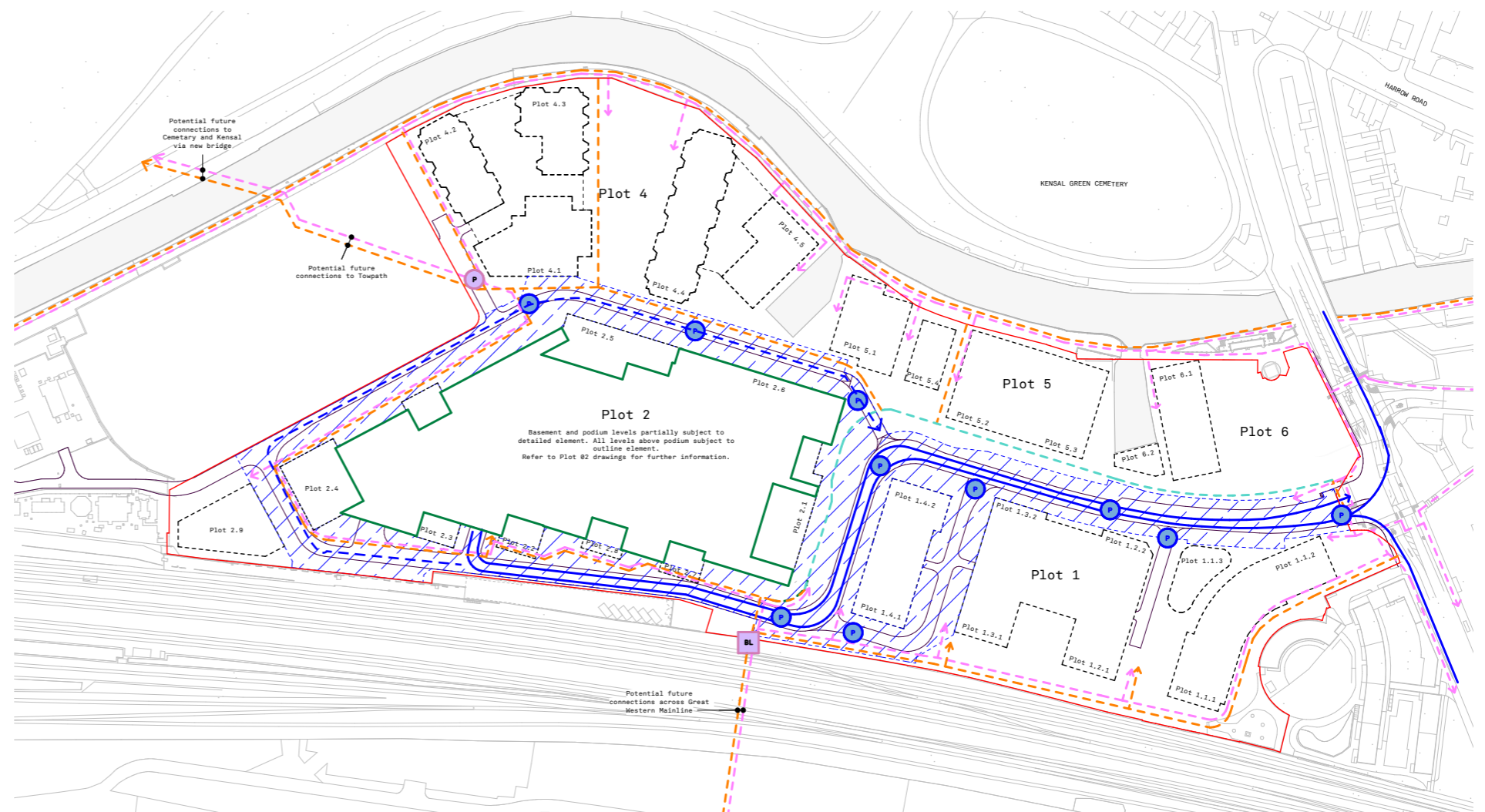

Fig 4.18: Proposed Masterplan Pedestrian and Cycle Movement Strategy.



Fig 4.17: SPD Diagram: Walking and Cycling Connections

4.4.2.3 B3.2 Improved Access to Public Transport

The SPD requires the development to improve the access to public transport including an enhanced and expanded bus network, and Improving the existing bus network and the pedestrian experience has been integral to the proposals. The bus stops within the masterplan have been placed in areas of high quality public realm, such as the areas in front of Plot 2.1 and 5, where generous tree planting and soft landscaping will create a welcoming arrival for pedestrians and a highly legible route to the new Sainsbury's Store. A third bus stop has been created on the southern edge of Canalside Park to provide public transport connections for residents of Plot 04 and 03. Four bus stands have been provided on the south western corner of the masterplan to provide drivers with a place to stop and rest.

The nearest tube stations to the site are Kensal Green to the north west, Kensal Rise to the north and Ladbrooke Grove to the south. Pedestrian and cycle routes to these stations will be improved through the new pedestrian and cycle network previously described. The introduction of the potential Railway and Canal pedestrian crossings will also enhance connections.

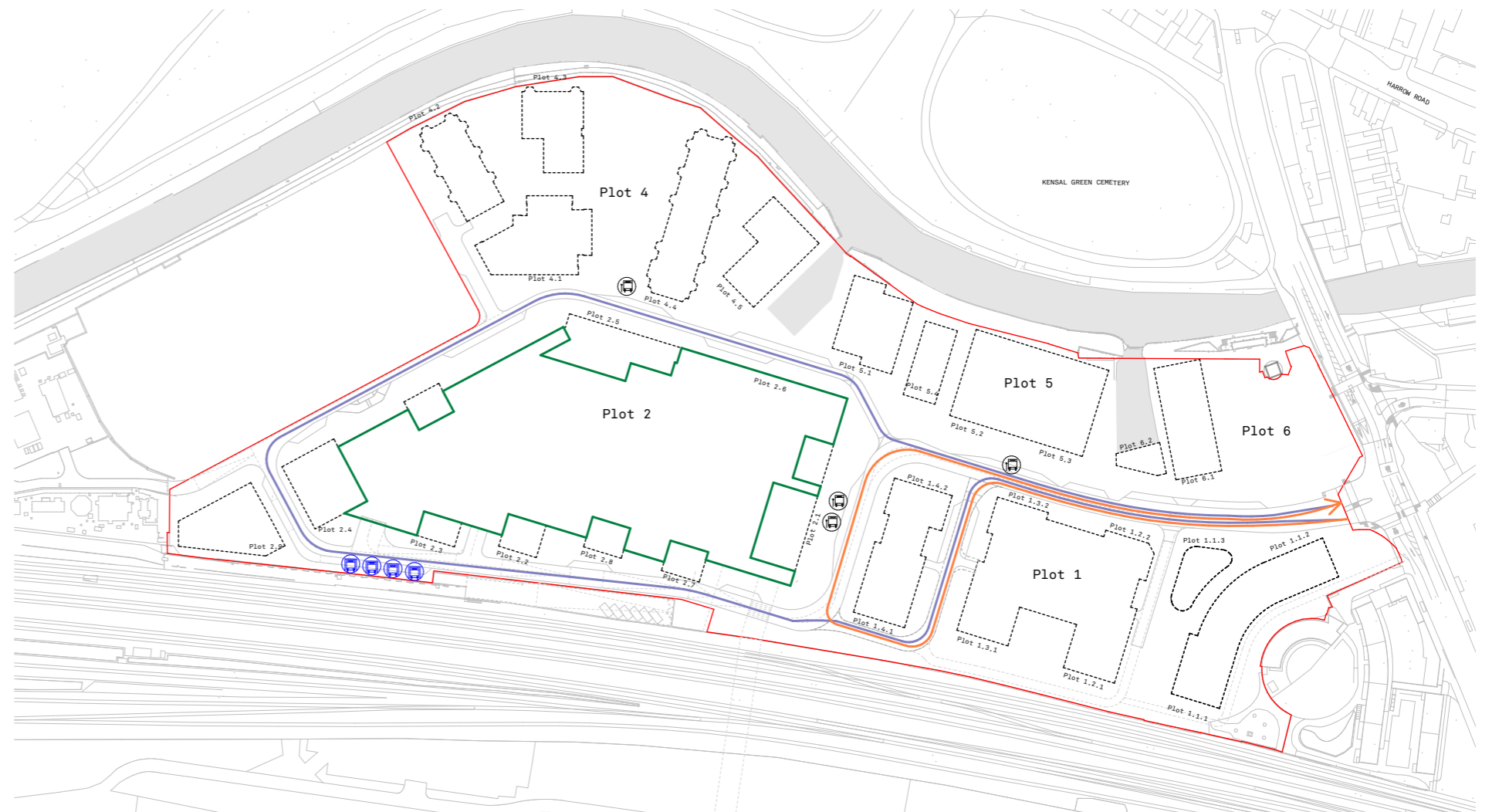

Fig 4.20: Proposed Masterplan Bus Movement Strategy

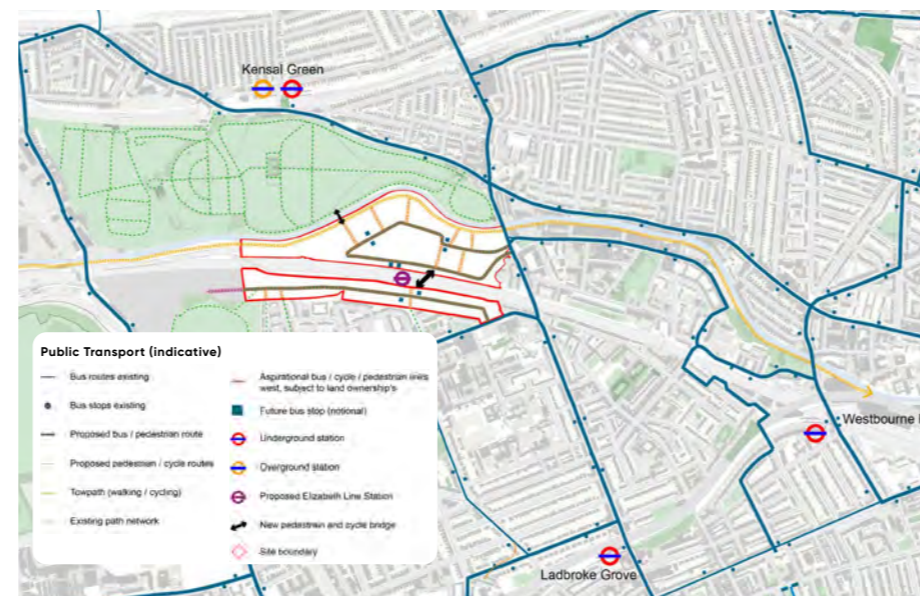
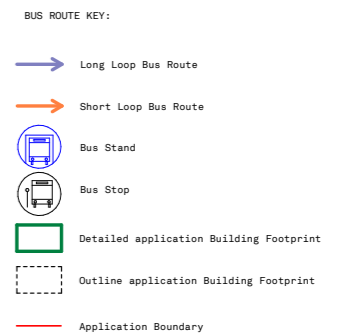

Fig 4.19: SPD Diagram: Improved Access to Public Transport



4.4.2.4 B3.3 Road Access

The SPD requires the development to deliver a safe and improved junction on Ladbroke Grove and the proposed road network follows the key principles of the SPD. A new signalised entrance junction will provide improved pedestrian and cycle crossings and dedicated lanes to access the site from the north and south on Ladbroke Grove. Within the masterplan, two way roads are framed by buildings and commercial frontages along The Avenue (shown in orange lines on the SPD diagram below and in pale red on the proposed masterplan drawing) and this road connects to South Drive to provide access to the proposed Sainsbury's Store car park and service area (shown in turquoise on the SPD diagram). As indicated, these roads all fall within the Detailed element of the application.

Unlike the SPD we do not continue the turquoise route along the southern edge of the masterplan, and have instead introduced a large area of public realm, termed 'South Terrace' in the proposals. This vehicle free area (other than emergency vehicles) provides amenity space to the Plot 01 residents and provides pedestrian connections to the existing memorial garden, at the south eastern corner of the masterplan. This strategy serves to reduce the number of roads within the masterplan and reinforces the main pedestrian high street, known as The Avenue, which runs through the centre of the masterplan and aligns to the site entrance at Ladbroke Grove.

In consultation with RBKC, a 3.7m wide one way road (shown in light green on the proposed masterplan) around Plot 02 known as West Drive has been introduced to enhance the pedestrian experience by increasing the available area for soft landscape within the public realm and to limit traffic movements.

Yellow 'access only' roads provide vehicle access to the basement car parks in Plot 01 and Plot 04, and to the existing Cadent infrastructure site to the west. This follows the principle of quieter 'neighbourhood streets' as indicated in the SPD.

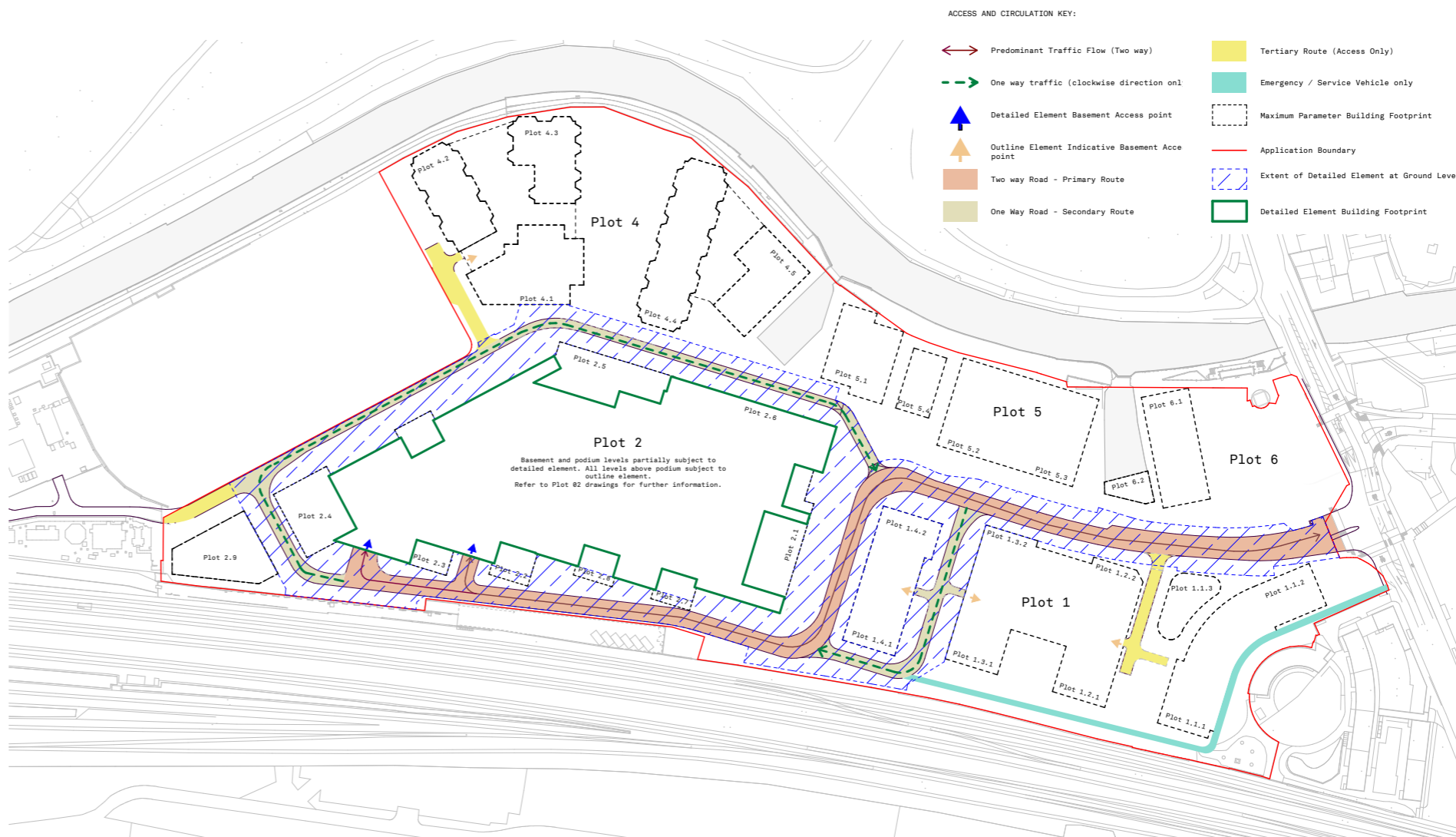

Fig 4.22: Proposed Masterplan Access and Circulation

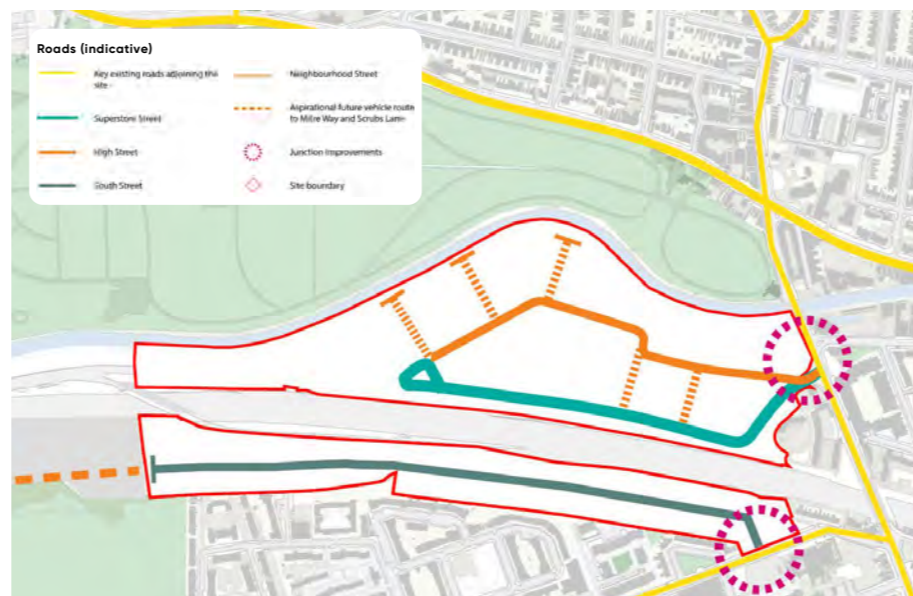

Fig 4.21: SPD Diagram: Road Access

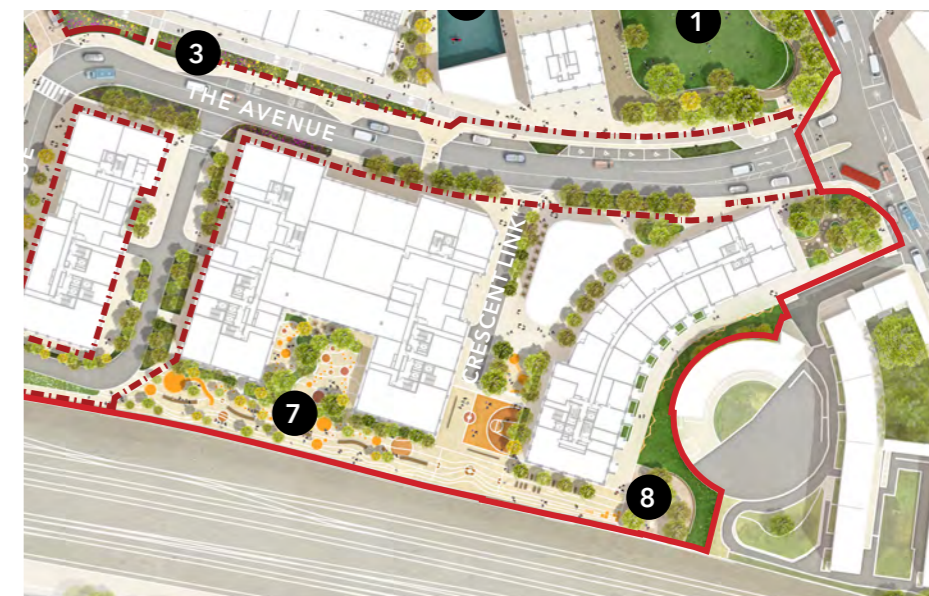

Fig 4.23: South Terrace (7) and memorial garden (8)

4.4.2.5 B4: Street and Spaces

The design of the streets and public spaces has been designed in accordance with 'Healthy Streets' guidelines in line with the SPD requirements. Walking, Cycling and Public Transport have been prioritised over vehicle movements as illustrated in the previous section.

Tree lined streets, specified to thrive in the environments in which they are planted, soft landscaping, green and blue roofs and rainwater attenuation have been embedded within the public realm strategy and form part of the detailed landscape proposals submitted as part of the application.

A number of key public spaces have been provided within the masterplan which provide routes through each space to help integrate them into the wider site as shown on the adjacent drawing.

An inclusive and accessible neighbourhood which is well lit and safe has been fundamental to the proposals. The two potential pedestrian bridges have been designed for within the proposals by safeguarding the landing positions and ensuring they will be well overlooked and legible.

Roads have been designed to adoptable standards throughout the masterplan and a priority has been given to active travel modes through the cycle and footpath networks across the masterplan. Transport and Travel Plans have been provided within the application which provide full details of the proposals.

The canal towpath has been integrated into the outline proposals by making it a key part of the pedestrian and cycle access strategy. Pedestrian routes through the masterplan via 'Canalside Park', the 'New Wharf', the 'Boathouse Basin' and 'Ladbroke Gardens' further integrate the towpath into the proposals. A sympathetic lighting strategy along the canal edge will limit the impact upon existing site ecology while providing an inviting and safe environment for pedestrians and existing canal residents and users.

A detailed waste strategy has been provided within the application which addresses both the strategy for the outline elements of the scheme (such as waste collection points from the outline plots) and the detailed elements (such as the ground floor of plot 02 and the service, refuse and loading bays located across the masterplan where appropriate).



LEGEND

- | | | | | | | | |
|-------------------------|--|---|----------------|---|---|---|---|
| — (Solid Red Line) | Outline Planning Application Boundary | ③ | Raingardens | ⑦ | South Terrace | ⑪ | Adjacent St. William Development |
| - - - (Dashed Red Line) | Detailed Planning Application Boundary | ④ | Denby Square | ⑧ | Memorial Garden | ⑫ | New Sainsbury Store |
| ① | Ladbroke Gardens | ⑤ | New Wharf | ⑨ | Improved Road Layout + Widened Footways | ⑬ | New Sports Centre |
| ② | Boathouse Basin + Water Activities | ⑥ | Canalside Park | ⑩ | Lowered Boundary Wall | ⑭ | Potential Future Pedestrian/
Cycle Bridge Link |

Fig 4.24: Proposed Landscape Masterplan showing key public spaces

4.4.2.6 B:5 Live, Work and Visit

5.1 Live

The scheme is being submitted as a hybrid application, with the proposed Sainsbury's Store and the main routes through the site being submitted in detail. All of the residential and most of the commercial components of the scheme are being submitted in outline.

Housing has been designed to meet the minimum site allocation of 3500 units within the total opportunity area, with just over 2500 homes proposed as part of this development. Housing within the illustrative scheme has been designed to have a range of unit sizes and will be split between affordable and private, with 24% affordable housing proposed (measured by habitable room). Housing will contain accessible and adaptable units to cater for all users. Affordable housing will be designed so that cannot be distinguished from homes for private sale. Affordable housing will comprise a mix of social rent and 'intermediate' sale.

The 16 existing affordable homes on site, contained within Boathouse Centre, will be re-provided within the masterplan. These will be provided over and above affordable housing offer. The development will be phased such that residents can move directly into their new home without the need for temporary housing.

5.2 Work

The site has been designed to accommodate up to 5000sqm of new office and workspace, to be distributed as illustrated on the parameter plans. The positions have been indicated to create a commercial focus to the ground floor at the eastern 'busier' edge of the masterplan (in line with the SPD Neighbourhood Centre) which in turn allows the western edge to contain a more residential focus. Detailed analysis has taken place through the work of Future City and Churchill & Partners to assess the 'meanwhile' and future commercial uses across the site and the appropriate locations for certain use classes and typologies.

5.3 Visit

Up to 14,500sqm of non-residential floorspace is proposed within the Outline Element of the scheme, in addition to the replacement Sainsbury's store. The site has been designed to provide a new Neighbourhood Centre which is terminated by the new Sainsbury's store, and will serve the day to day needs of the existing and incoming community.



Fig 4.26: Proposed Masterplan - Indicative Use Classes

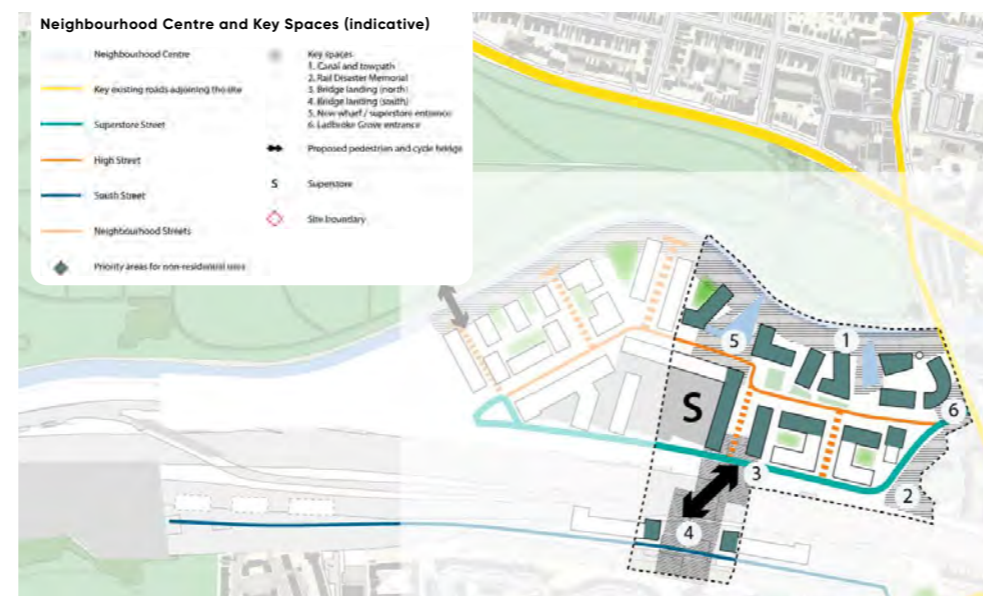

Fig 4.25: SPD Diagram: Neighbourhood Centre

NON-RESIDENTIAL USE KEY:	INDICATIVE PLANNING USE
Site Parcel Hub	CLASS E
Sainsbury's Store	CLASS E
Restaurant & Cafe	CLASS E
Independent Retail	CLASS E
Workshop / Flexible Workspace	CLASS E
Leisure & Service	CLASS E / SUI GENERIS
Commercial Space	CLASS E
Cycle Hub	CLASS E
Pavilion Building (Bar/Bistro)	CLASS E / SUI GENERIS
Club Entrance Building	SUI GENERIS
Creche	CLASS F
Community Space	CLASS F
Office Space	CLASS E
Affordable Workspace	CLASS E
Plot 02 Amenity	CLASS E
Reposition of Office Space (Canalside House)	CLASS E

4.4.3 B:6 Character

4.4.3.1 Response to Context

The site is unique in its context within the borough. As part of the initial site response the applicant team compiled the adjacent diagram, showing the balance of influences acting upon the site. This diagram acknowledges the key impact that the rail corridor, the cemetery, the canal, the former industrial site use and Kensal Town have on the site, in tandem with the wider borough.

The distinct nature of the site is acknowledged by the SPD and creates its identity. The influences highlighted begin to illustrate how the site has been subdivided between a quieter western half, influenced by the cemetery and a eastern half which references the activity and bustle of the wider 'Ile' of Kensal Town to the east, also framed by the canal and railway line.

It is acknowledged in the SPD that a 'step change' is required to deliver the housing allocation on site. In order to do this, the scheme has drawn on the urban identity of the borough where its material palette, building lines, fenestration and balcony design have been referenced within the design codes for each plot.

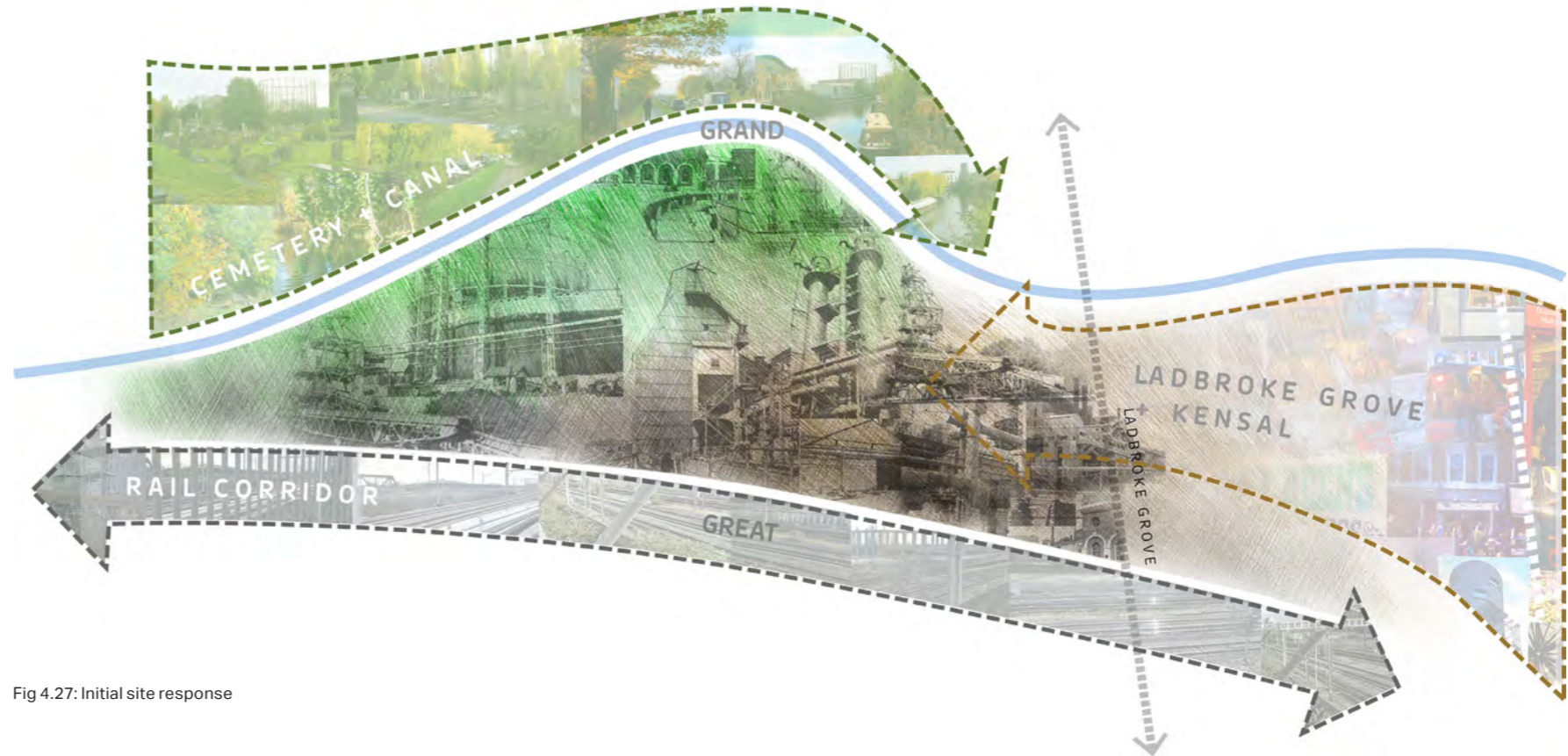

Fig 4.27: Initial site response

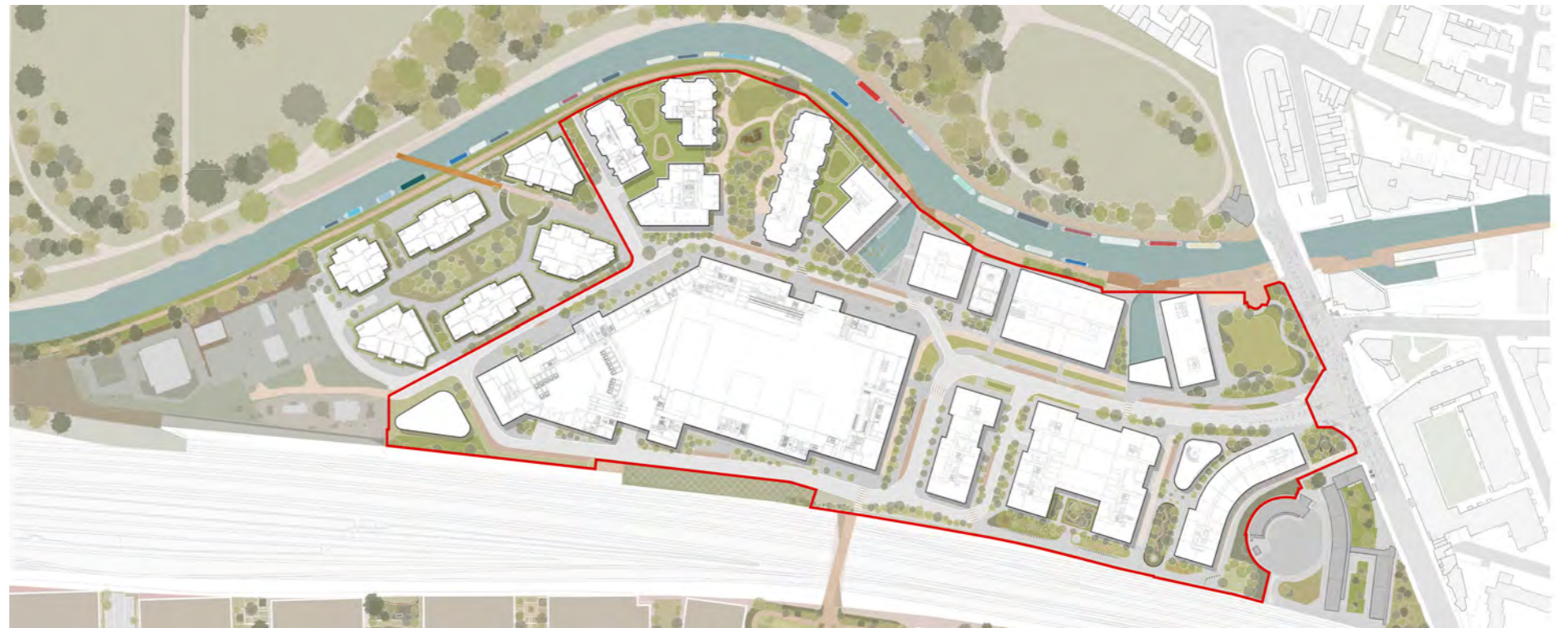

Fig 4.28: Current Masterplan

4.4.3.2 Height & Massing

The SPD highlights a broad approach to height and massing within the extract below. Purple tones denote where height generally between 4 and 20 storeys is appropriate, with greater height adjacent the railway line and lower height to the canal edge. These principles have informed the masterplan and have guided the massing approach as is evident in the proposed massing opposite. Taller towers have been placed on the railway edge which relieves the canal edge for lower storey buildings, generally between 9 and 10 storeys.

Moments for height in excess of these ranges have been highlighted by black dashed lines in the SPD. These have been noted below alongside the applicant teams response:

1. The site entrance adjacent Ladbroke Grove junction. We have placed a marker building here, known as Plot 6.1, which acts to frame the new public park to the east. The height steps towards the canal edge to a maximum of 12 storeys to create a distinct site marker in keeping with the scale and character of buildings on Ladbroke Grove.
2. The store marker. One of the two tallest buildings on site has been placed here, known as Plot 2.1. The building acts to signal both the end of The Avenue (the new Neighbourhood Centre) and the position of the new store. The building is also placed to articulate the potential new bridge crossing position across the railway line which will become of 2 main pedestrian thoroughfares into the site, alongside The Avenue.
3. A western marker. This marker addresses the shift in site geometry, driven by the sweep of the canal and the potential river crossing to the west where the site is at its widest. The second tall building, Plot 4.1, has been placed here and offers a distinct architectural response which also acts to signal the large public park at its base, which opens towards the canal edge.

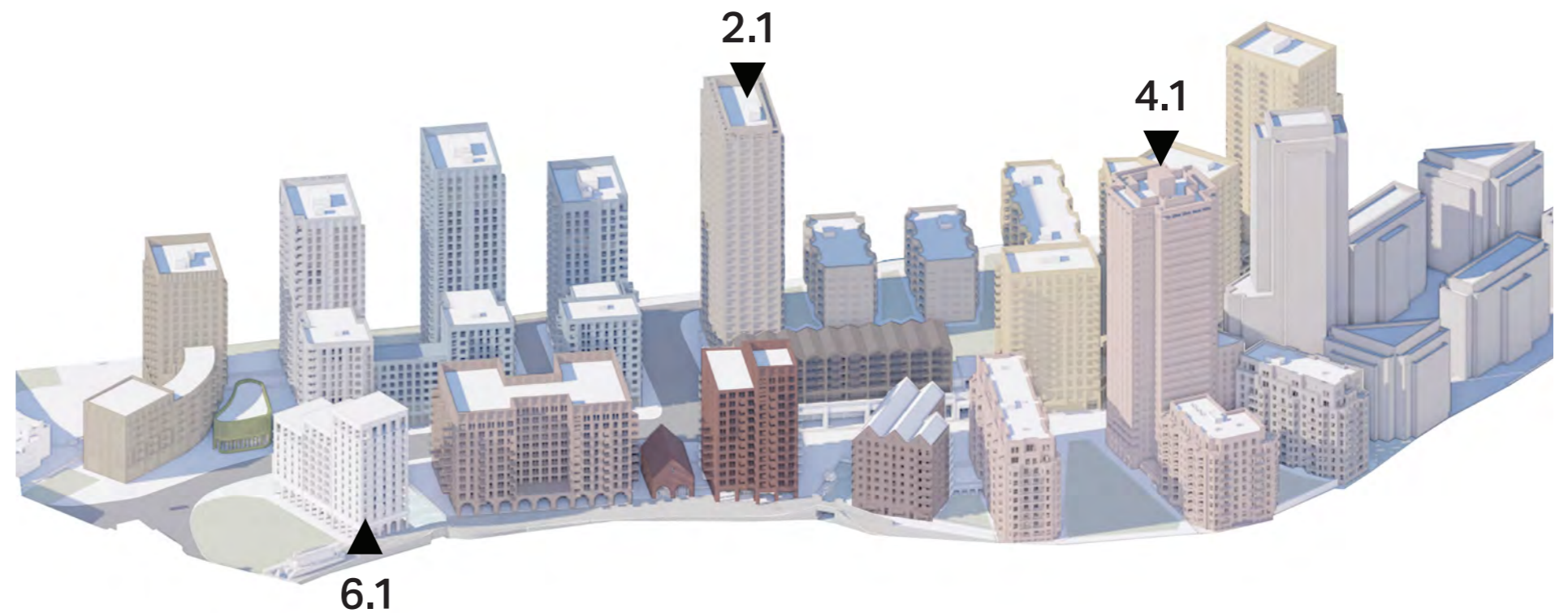

Fig 4.30: The Proposed Height and Massing

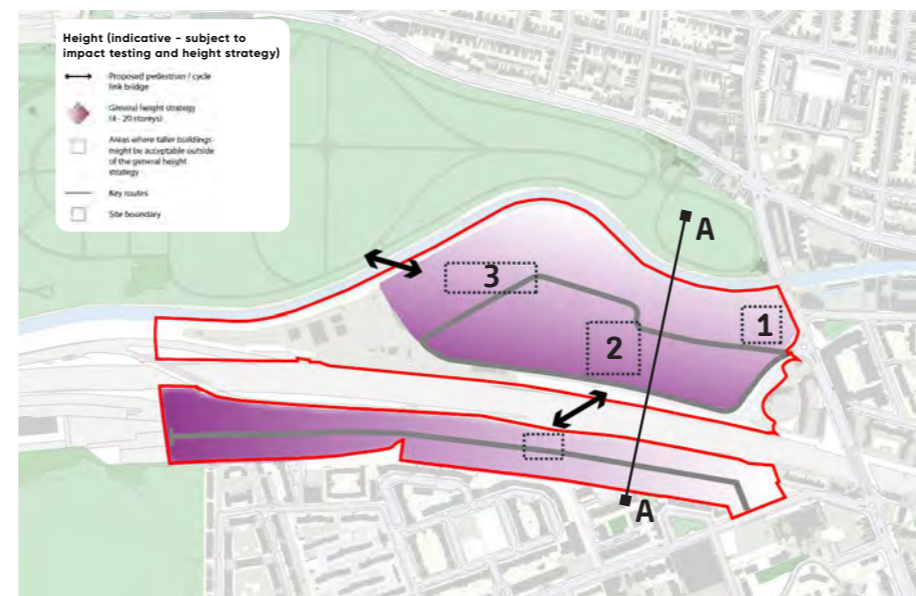

Fig 4.29: SPD Height Strategy

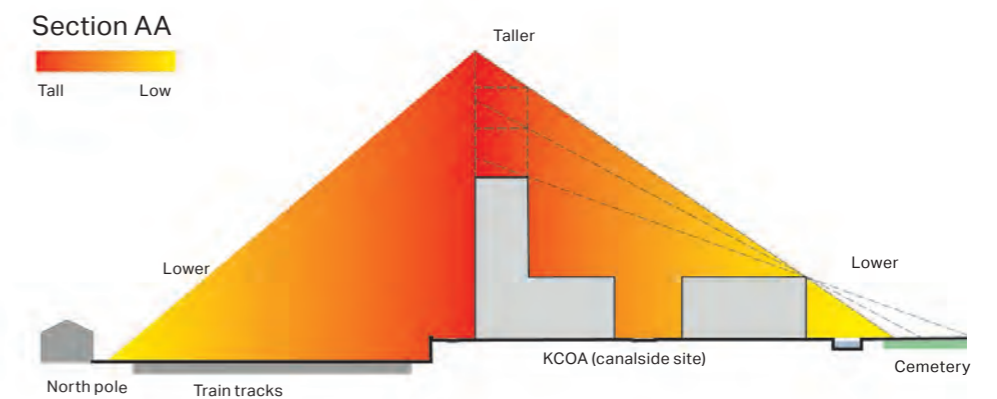

Fig 4.31: Approach to height Strategy

4.4.3.3 Character Areas

The proposed masterplan follows the arrangement of key character areas closely, as illustrated in the SPD indicative character areas drawing below.

The northern half of the Opportunity Area has three main character areas which are explored below:

- Area 1: The eastern edge of the masterplan acts as its Neighbourhood Centre. Here, commercial buildings front 'The Avenue' and clearly articulate this key route from Ladbrooke Grove. Buildings are lower in scale where they face The Avenue, to create a sense of enclosure. A mix of both community uses and retail use will create activity here and vibrant frontages will further enliven the space.
- Area 2: The area of the masterplan which is predominantly residential focused and as such is distinct from the east. Quieter in character and with a strong relationship to the canal, buildings here are generally smaller in scale and convey some of the character and architecture of the borough in a more explicit manner.
- Area 3: This area is characterised by the re-provision of the Sainsbury's Store and the new residential buildings which sit above it. Despite the challenges of integrating residential units around a functioning store, it has been possible to integrate active frontages on all sides of the building, either through small commercial units, community uses, residential entrances and the new store entrance itself.

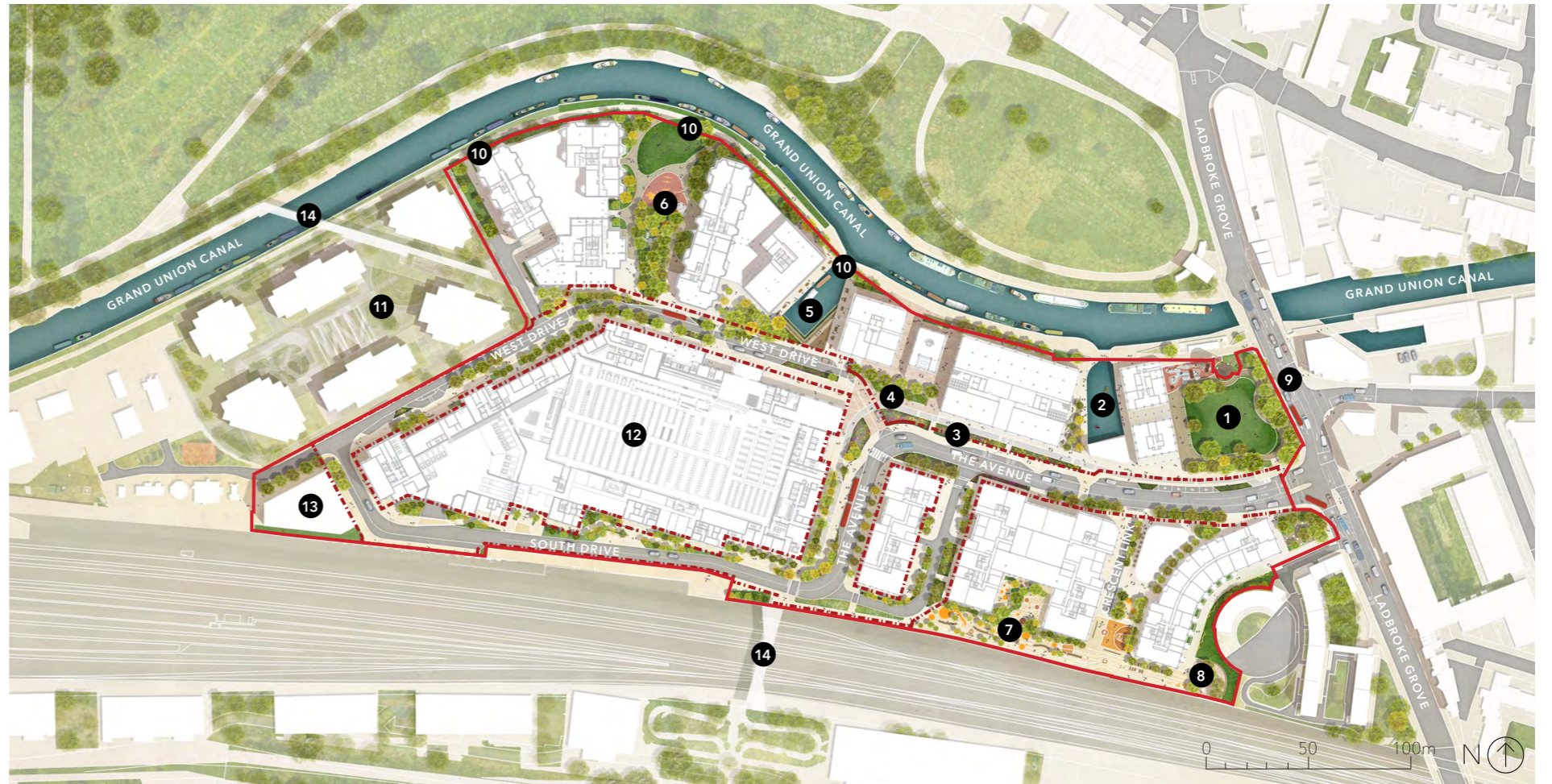

Fig 4.33: The Proposed Landscape Masterplan

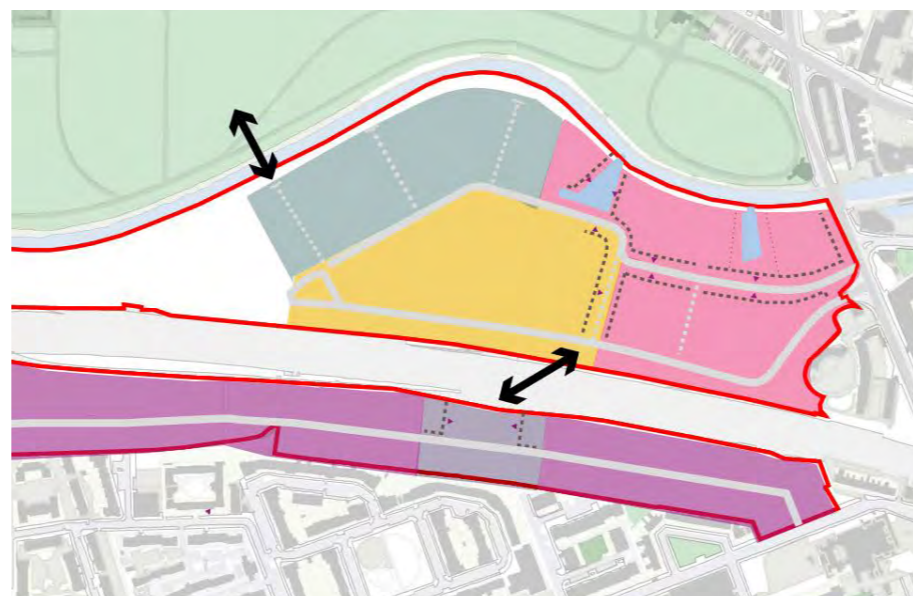

Fig 4.32: SPD Character Areas

Character (indicative)

- | | | | |
|--|---|--|------------------|
| | Proposed primary road through site | | Area 1 |
| | Proposed secondary streets (notional) | | Area 2 |
| | Pedestrian / cycle link to wider area | | Area 3 |
| | Proposed pedestrian / cycle link bridge | | Area 4 |
| | | | Area 5 |
| | | | Active frontages |
| | | | Entrance space |

4.4.3.4 Safeguarding Bridge Locations

The site contains two locations for potential bridge crossings, one at the western edge of the site, which will be accessed via Berkely St William's land (known as Plot 03) and one which will be accessed from the southern edge of the masterplan, and will provide access for both pedestrians and cyclists across the Great Western Mainline (GWM). Within our proposals, the bridge landing points have been safeguarded to ensure they can be integrated once the appropriate agreements have taken place. The GWM bridge, illustrated opposite, does not form part of the planning submission as it is reliant on third parties, delivery timescales and the proposals of neighbouring sites. However, the Applicant is committed to working with the Council and other stakeholders to facilitate the successful delivery of both bridges.

An initial concept design for the railway bridge has been prepared by Studio Bednarski, who are a local design practice known for their innovative bridge designs. This has been done to test the feasibility and constraints of situating a bridge in this location. The bridges structure and aesthetics have been informed by the physical challenge of spanning the railway line and the need to integrate the structure into the wider borough, in order to create a unique arrival point.

A significant level change between the southern and northern edges of the railway line have also been considered in the proposals. Ground level rises from a height of +24m AOD to the south of the railway to a height of +30.80m AOD on the northern side. A meandering landscaped route has been proposed on the southern edge of the Great Western Mainline to address this challenge. Centrally positioned steps would also facilitate access up to the bridge.

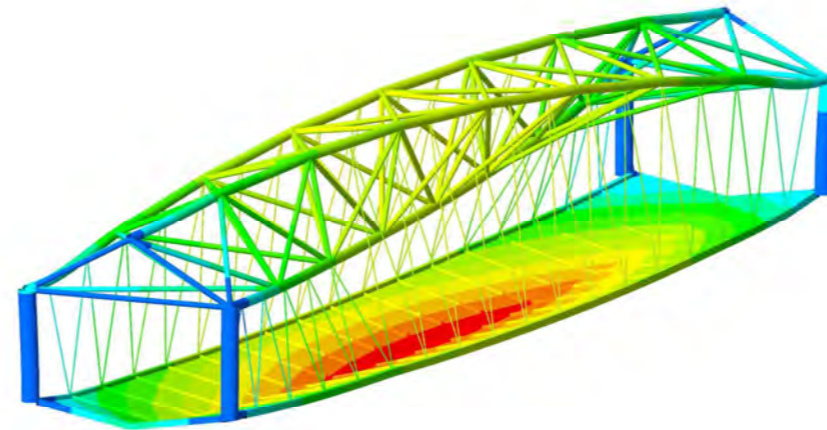

Fig 4.35: Indicative bridge structural tests



Fig 4.36: Indicative bridge precedent

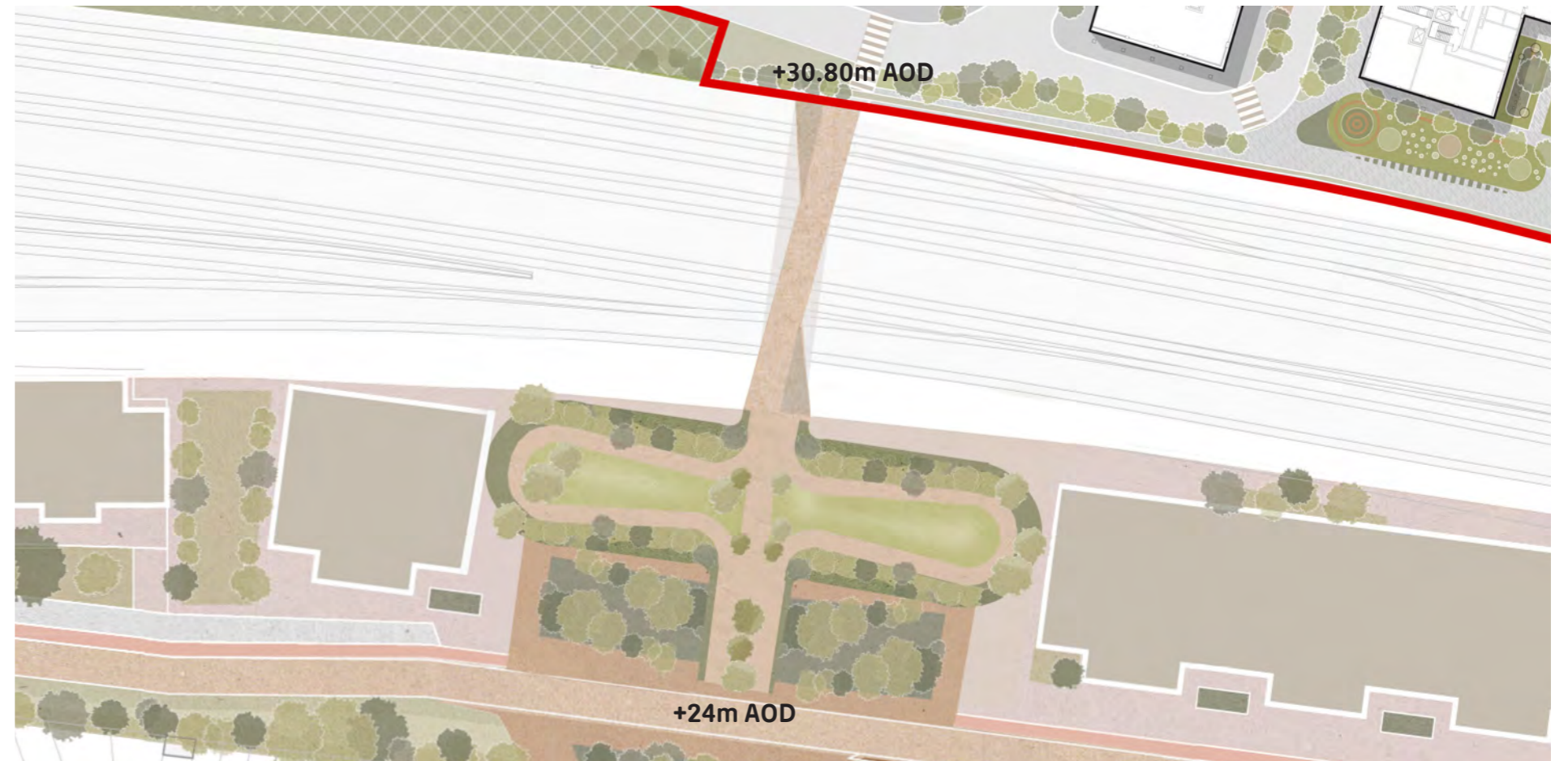

Fig 4.34: Indicative bridge proposals showing landscape walkway and bridge crossing.

4.5 QRP Feedback

4.5.1 The Quality Review Panel

The Applicant Team alongside the Berkely St William team originally presented the scheme to the Kensington and Chelsea Quality Review Panel (QRP) in July and October of 2021 to cover a variety of themes as outlined below:

- Kensal Canalside thematic topics: open space, landscape and streetscape; building heights and massing; housing typology and tenure, 4 October 2021
- Kensal Canalside transport and connectivity, 7 October 2021
- Kensal Canalside environmental sustainability, 7 October 2021
- Kensal Canalside Plot 2, 23 July 2021
- Kensal Canalside Plot 3, Gas Works, 14 October 2021
- Kensal Canalside Plot 4, 14 October 2021
- Kensal Canalside Plot 1, 5 & 6, 14 October 2021

Subsequent to these meetings the team have been working to address a number of the concerns which were highlighted whilst reflecting on planning officer feedback and the evolving requirements of the Building Safety Act and resultant changes to Building Regulations and British Standards.

As a result of these changes the team presented the current updated masterplan to the QRP on 29th June 2023. The meeting focussed on the key themes outlined below:

- Formal review of Plots 2 and 6
- Public realm, landscape and streetscape
- Scale, height and massing
- Land use: housing, commercial, community

4.5.2 QRP Formal Response

A formal response letter was issued by the QRP on 18th July 2023 which responded to the key themes which were presented in the meeting on 29th June 2023. The responses have been summarised below:

1. The panel recognises the need to deliver more housing, but this shouldn't be at the expense of high-quality housing and placemaking
2. Inclusion of the RBKC land and the provision of public space at the front of the site is supported
3. Plot 1.4 should be removed to provide additional public open space (homes relocated to the North Pole site)
4. Improvements to South Drive are needed – with wider pavements on both sides of the road
5. Residential above the store is welcomed but the panel doesn't consider the proposed finger blocks to be a typical Kensington and Chelsea typology (comment reiterated for finger block typology in Plot 1)
6. Clear and robust design code and parameter plans needed given level of outline proposed
7. Concern over height of tallest buildings – buildings above 20 storeys are challenging given the context and character of the borough. Generous open space required to justify level of height and visual impact. A reduction of 500 homes 'might offer the necessary relief'.
8. Recommend reinstating West Drive as a two way road
9. Plot 2 – further detail on separation distances, defensible space and amenity provision required

4.5.2.1 QRP Response 1:

'The panel recognises the need to deliver more housing, but this shouldn't be at the expense of high-quality housing and placemaking'

The desire to provide high quality housing and homes, across all tenure types, has been central to the proposals as the illustrative schemes have been developed. Care has been taken within the Design Code and the parameter drawing set to ensure that all elements brought forward in outline contain a robust series of rules and recommendations to ensure that the quality and design rationale conveyed in the illustrative scheme is maintained as each plot is brought forward in detail.

The site has drawn upon the influences of Kensal Town (itself an 'island' site, bound by the Canal and Railway Line) and the wider borough to shape the landscape strategies and the public realm as a whole. This approach serves to anchor the proposals within its context and foster a sense of familiarity, whilst carefully balancing this with the need for housing of all tenure types.



Fig 4.37: Housing flanking the canal

4.5.2.2 QRP Response 2:

Inclusion of the RBKC land and the provision of public space at the front of the site is supported

Plot 06 is currently occupied by a number of different existing buildings and infrastructure which abut the existing Sainsbury's car park. The site is comprised of the Boathouse Centre which is occupied by the London Sport Trust and 16 homes split across the upper levels of the building. Boathouse Centre is built over the existing basin which flanks the western edge of the Plot 06. Canalside House lies in close proximity to Ladbroke Grove at the site entrance. Directly to the west of this building there is an existing gas line, shown on the diagram opposite. The existing Sainsbury's car park occupies all of the remaining portion of the Plot 06.

The proposed solution places a new building against the existing basin, to create a large public park, known as 'Ladbroke Gardens' at the eastern edge of the site. This gesture acts to reinforce Plot 06 as a 'gateway' moment at the threshold of the masterplan, whilst responding to the character of West Kensington, where generous gardens flank regency housing. Plot 06 is explored further in Section 11 of the Design and Access Statement.

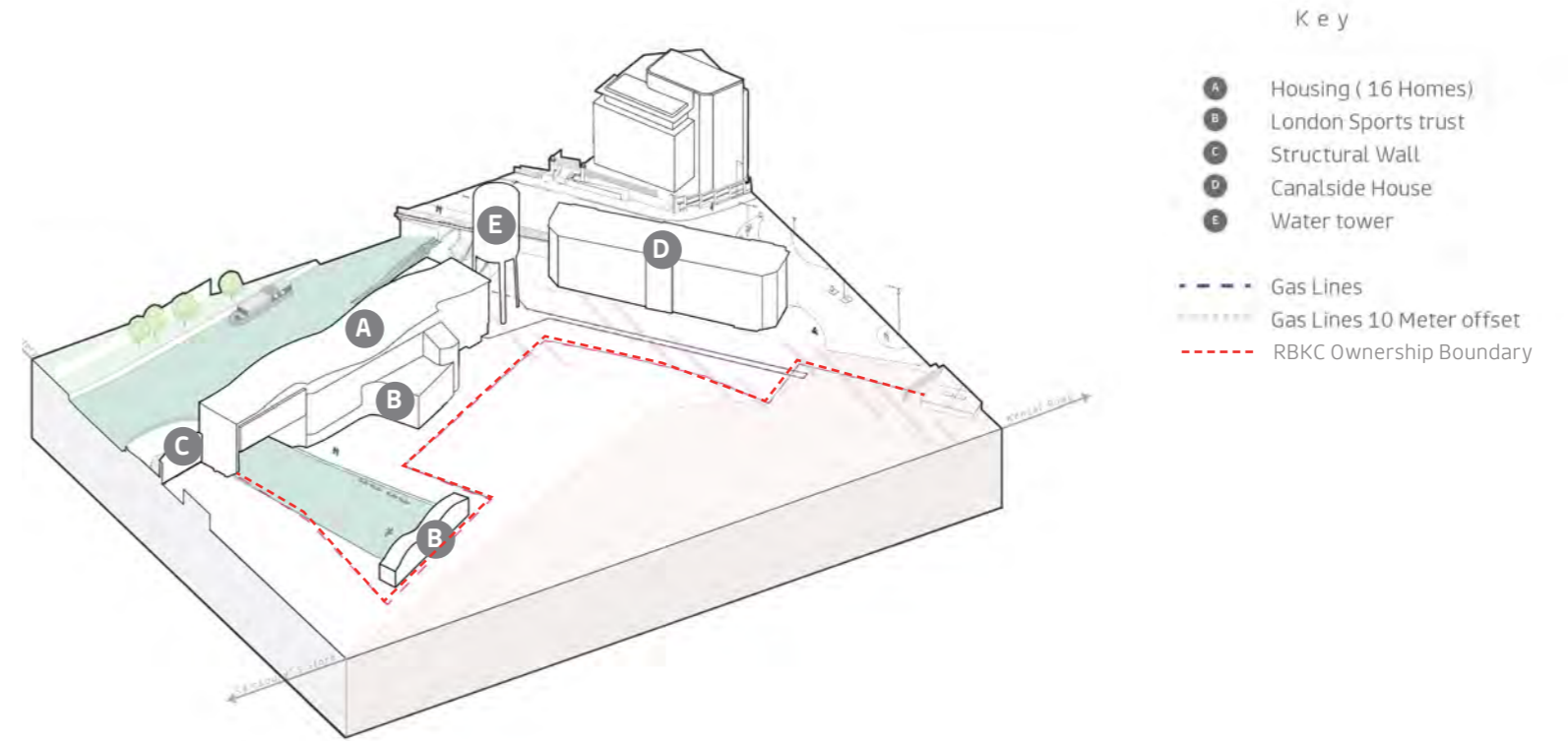

Fig 4.40: Existing Plot 06 Configuration

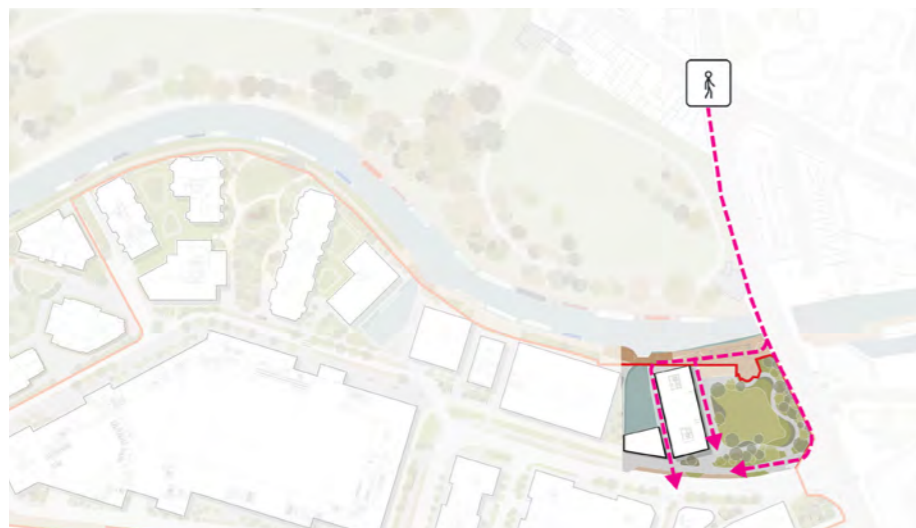

Fig 4.41: Plot 06 as a publicly accessible threshold

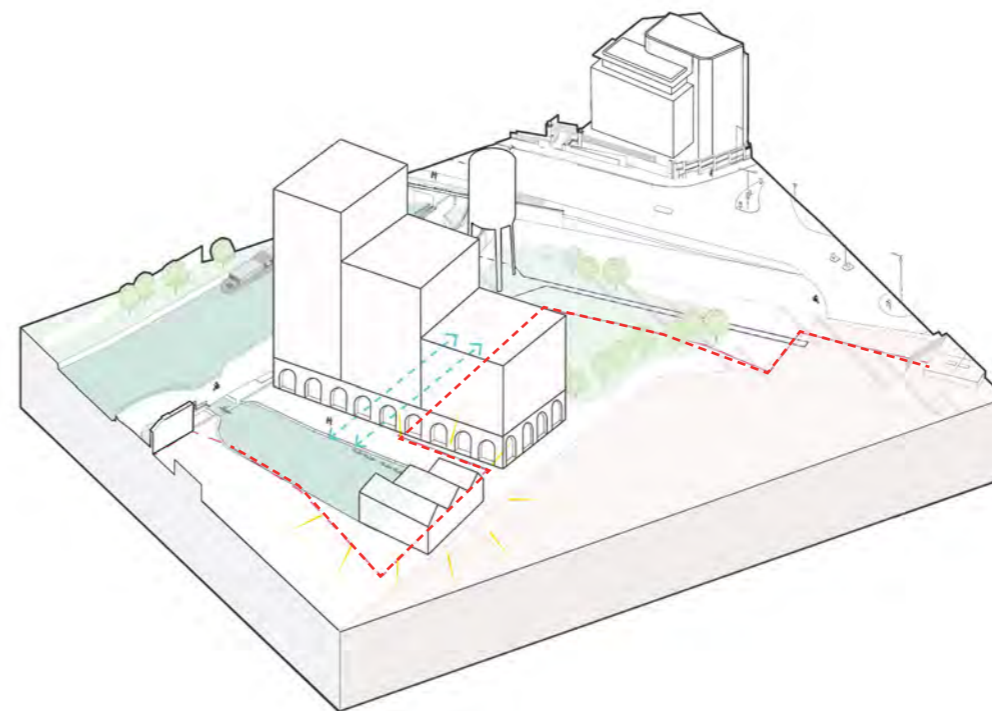

Fig 4.39: Proposed Plot 06 Configuration

4.5.2.3 QRP Response 3:

Plot 1.4 should be removed to provide additional public open space (homes relocated to the North Pole site)

The diagram adjacent displays an option for introducing an additional area of public open space within the masterplan, to the east of Plot 2.1.

Introducing a public space in this location would require a roundabout at the end of the Avenue to facilitate bus movements in and out of the site and would result in a garden space framed by roads on 3 of its sides.

Removing Plot 1.4 would result in a loss of c.200 residential units within the masterplan, which in turn would have an impact upon the site viability and as such, the affordable housing provision. In addition to this, the Kensal Opportunity Area currently has a minimum unit target which could not be re-provided on the adjacent St. William 'Plot 03' site or the 'North Pole' site without significantly increasing the density on these plots. This in turn would bring challenges due to the proximity to the conservation area, directly to the south of the North Pole site.

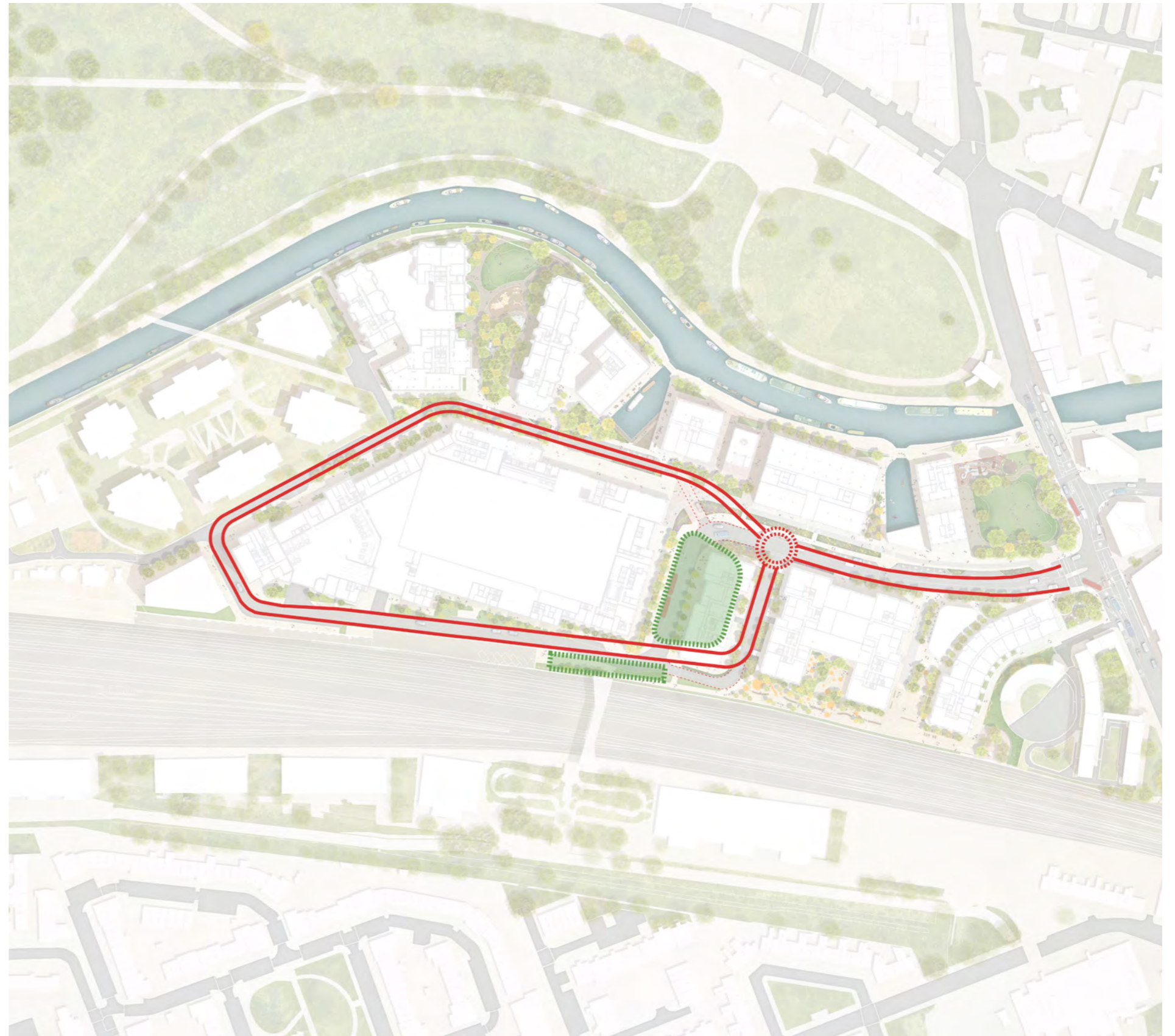

Fig 4.42: Removal of Plot 1.4 and introduction of new public realm

4.5.2.4 QRP Response 4:

Improvements to South Drive are needed – with wider pavements on both sides of the road

South Drive is a hard working area of the masterplan, which facilitates access to the Sainsbury's Store for both customers and service vehicles. The route also offers access to the reconfigured Network Rail compound, which runs perpendicular to the Great Western Mainline and the Cadent infrastructure site which is accessed at the far west of the site. Finally, the road also offers access to Plot 03, 04 and 05 via the one-way route known as 'West Drive'.

The adjacent diagram (fig 4.17) assesses the implications of adding a pedestrian route along the southern edge of South Drive, adjacent to the Network Rail boundary wall. The proposed Sainsbury's Store has been moved north to accommodate this and the resultant impact upon Plot 04, Canalside Park, Basin Wharf and Plot 05 has been indicated.

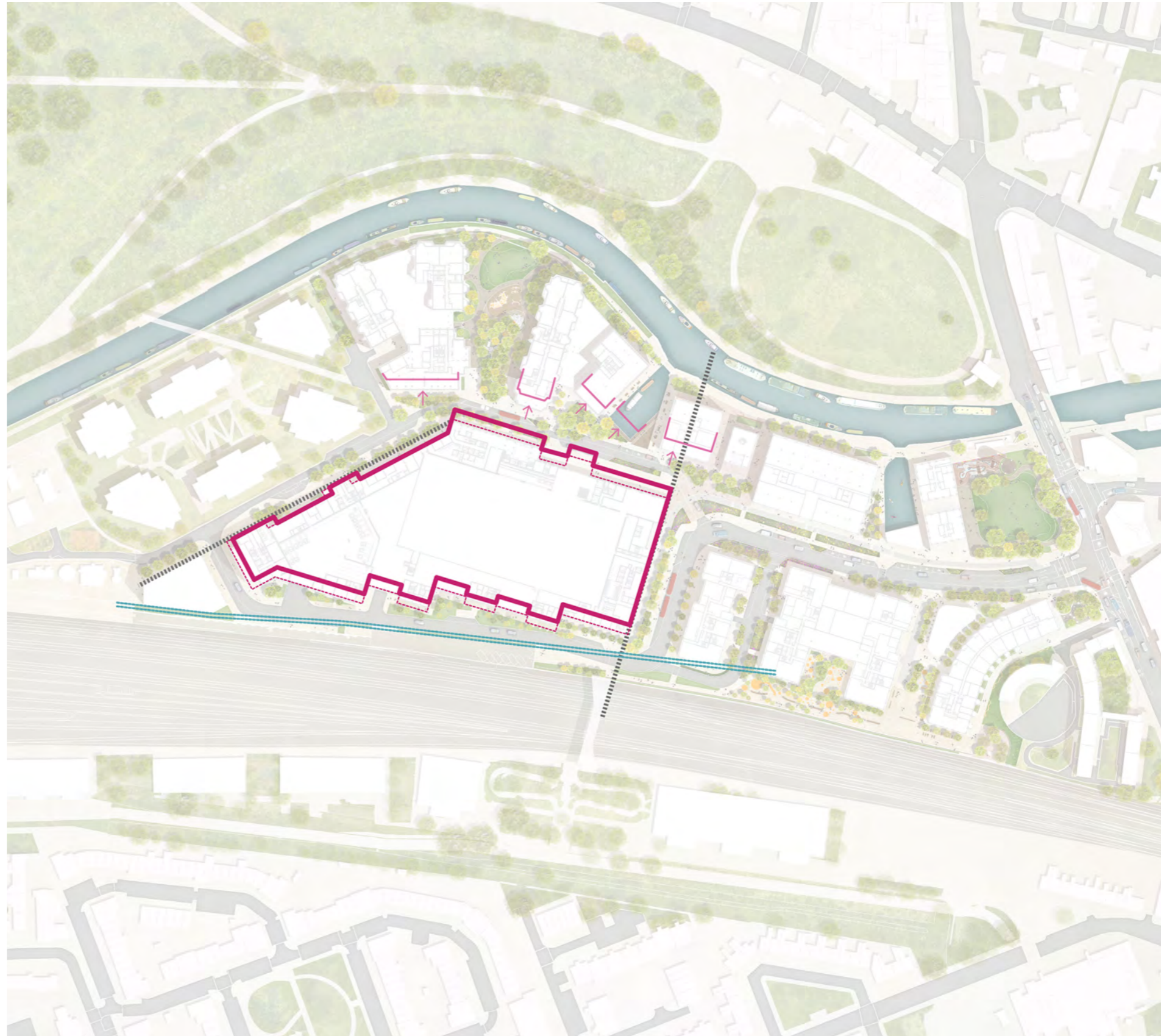

Fig 4.43: Adjusting Sainsbury's Store position to create a new pedestrian route on South Drive

4.5.2.5 QRP Response 4: South Drive - Before and After

As described on the previous page and in Fig 4.43 the implications of moving the store so as to provide pavements on both sides of the south drive are significant, and would adversely effect a significant part of the masterplan and effect that ability to provide generous public realm in one of the key spaces of the masterplan.

The move would also significantly reduce the footprint of buildings in this area, reducing the number of homes the scheme can provide.

As a result we have reconfigured the south drive public realm within the constraints set by the configuration of the store footprint, the size and alignment of the primary road for access to the Sainsbury car park and the access requirements for the network rail compound.

The quality of the South Drive pedestrian route has been addressed within the detailed landscape plans, submitted as part of the application where a meandering pedestrian route through areas of planting has been provided on the northern edge of the road. This allows pedestrians and cyclists to move through this space without being constrained to the building facades, allowing a much more natural, fluid and pleasant route, set within landscape.

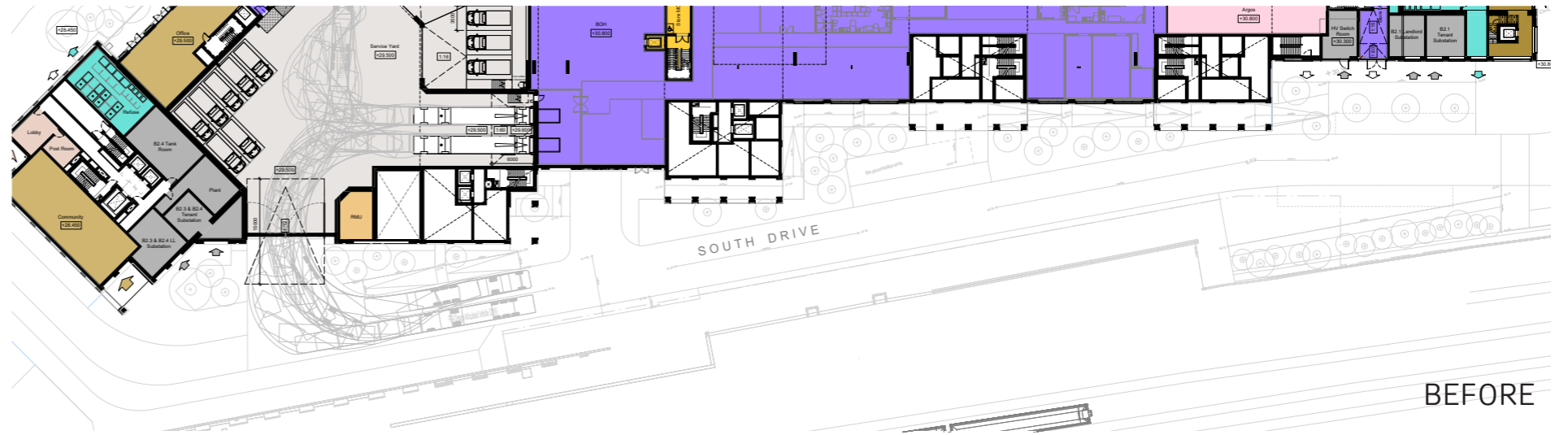

Fig 4.44: The South Drive arrangement, prior to the QRP feedback

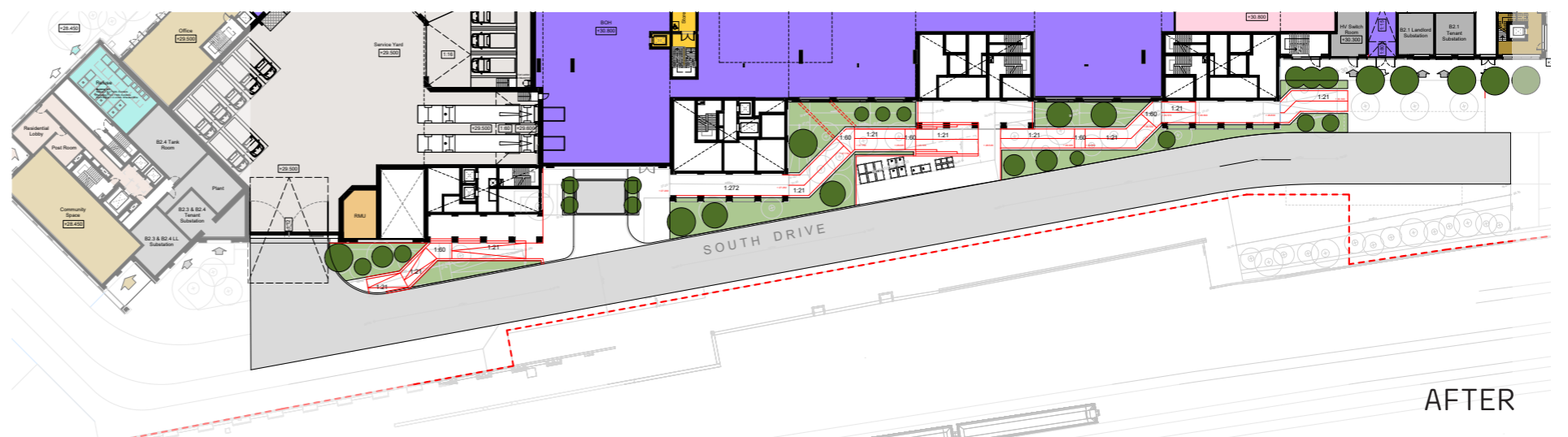

Fig 4.45: The South Drive arrangement, following the QRP feedback

4.5.2.6 QRP Response 5:

Residential above the store is welcomed but the panel doesn't consider the proposed finger blocks to be a typical Kensington and Chelsea typology (comment reiterated for finger block typology in Plot 1)

The site itself is unique within the borough of Kensington and Chelsea. The site sits at the borough's northern-most edge and is framed by the Grand Union Canal to the north and the Great Western Mainline to the south. As described in Chapter 2 and 3 of this document, the site is also framed by Ladbrooke Grove to the east and beyond this, Kensal Town. Kensal Town has a similar condition to the proposed site, given its 'island' nature created by the Canal and Railway Line and the prominent 'Trellick Tower', itself not typical of the borough as a whole. These influences make a differing housing typology appropriate in this location.

The 'north-south' finger block typology has been derived to maximise the amount of natural light entering public spaces across the masterplan and to limit the number of single aspect north facing units which would be generated through an east-west configuration. The typology also results in narrow building flanks facing south, which address the rest of the borough.



Fig 4.46: Narrow flanks created by a 'finger block' typology orientated North-South

4.5.2.7 QRP Response 6:

A clear and robust design code and parameter plans are needed given the level of outline proposed

In support of the application a comprehensive Design Code has been provided alongside a set of parameter drawings, which govern the overall layout and massing strategy and the architectural design intent.

The Design Code focuses initially on the wider masterplan before exploring the individual plot designs in greater detail. The plot sections are structured in a consistent manner as below:

- Connection to the wider masterplan
- Block Form & Arrangement
- Scale & Massing
- Use & Quantum
- Layout
- Active Frontages
- Facade Approach, Materiality & Detailing

The Design Code contains a series of 'Mandatory' rules and 'Recommended' guidance to direct future designers on the plot principles and to ensure cohesion across the wider masterplan. The prescriptive nature of the Design Code and relatively tight parameter range has been produced so that a robust and high quality solution is brought forward within the reserved matters application. The 'Mandatory' elements of the Design Code will be conditioned within any future approval which will further embed the quality aspirations of the scheme.

In addition to the Design Code, a series of parameter drawings have been produced to accompany the application. These introduce specificity to the layout, height and massing of each plot, so that the masterplan layout principles explored earlier are embedded within the scheme. The parameter plans also convey the split between the outline and detail elements of the scheme and the intended movement strategy and connection to the wider borough.

1.1.3 Structure of the Design Code

This Design Code has been written in a simple, clear format to enable the rules and recommendations to be easily read and understood by both technical and non-technical stakeholders. This will ensure that the code is accessible to as many users as possible.

The document is structured into three key sections.

- Section 2: Masterplan principles and site wide parameters capturing strategic issues that require whole site coordination.
- Section 3 - 7: Design guidelines for each individual development plot submitted in outline. Design codes have been prepared for all plots within the masterplan other than the proposed Sainsbury's Store in Plot 02, which is being applied for in detail.
- Section 8: Landscape, Lighting and Security guidelines.

This document should be read in conjunction with the supporting Design and Access Statement and planning drawings which describe the plots in further detail.

Each section of the Design Guide is broken down into a series of individual sub-headings to address strategic aspects of the overall design, as follows:

- Connection to the Wider Masterplan
- Block Form and Arrangement
- Scale and Massing
- Use and Quantum
- Layout
- Active Frontages
- Facade Approach, Materiality and Detailing

Each set of rules is accompanied by a graphical illustration and brief explanation of the rationale behind the rules and recommendations.

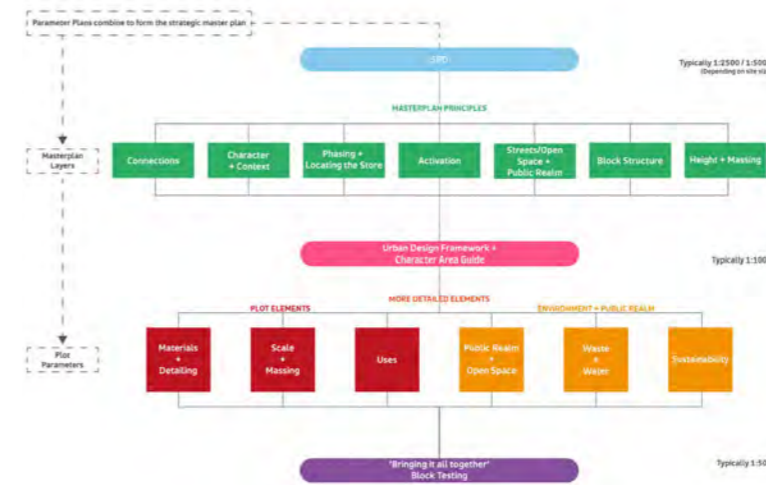

Fig 4.48: Extract of Design Code Structure

3.2.3 Maximum/ Minimum Parameters

The plans, sections and 3D diagrams opposite define the maximum and minimum proposed extents for the building. A 2m wide balcony zone surrounds the maximum parameter envelope. Both the minimum and maximum extents have been tested as part of the Environmental Statement (E.S). The balcony zone allows for flexibility on location subject to section 3.8.1. All heights shown are expressed as AOD (m).

Design Guidelines

- The design brought forward at reserved matters stage must not exceed the maximum parameter envelope and must not be smaller than the minimum parameter.

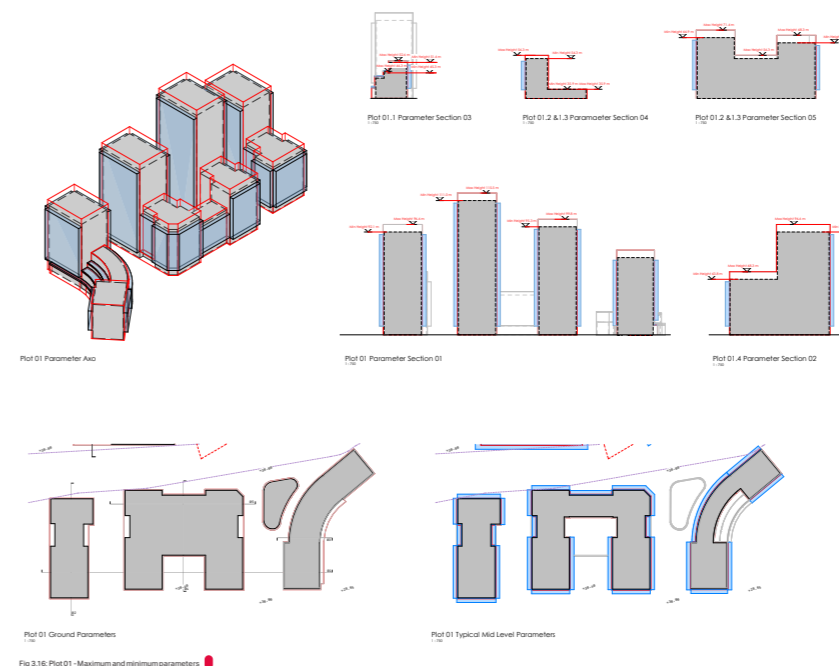

Fig 4.47: Extract of parameter drawings within Design Code

4.5.2.8 QRP Response 7:

Concern over height of tallest buildings – buildings above 20 storeys are challenging given the context and character of the borough. Generous open space required to justify level of height and visual impact. A reduction of 500 homes ‘might offer the necessary relief’.

The Kensal Canalside Opportunity Area Supplementary Planning Document (SPD) states that a minimum number of homes are to be provided across the opportunity area as follows:

‘a minimum of 3,500 new homes and 10,000 sqm of office space providing new jobs and opportunities’

The site has been thoroughly tested to deliver a balance between well day lit public open space, lower storey buildings to the canal edge and fronting the Avenue and moments of height, where appropriate, to create ‘markers’ (in the case of Plot 2.1 and 4.1). Taller buildings have been placed adjacent the railway edge, a strategy which is reinforced within the SPD, to relieve areas of the wider masterplan for lower storey buildings.

It is acknowledged within the SPD that *‘the scale and density of the development required at Kensal Canalside will be a step change from the existing pattern of development in much of the Borough.’* This is necessary to meet the housing allocation for the site as described above and to make the site economically viable. A project viability cost plan has been produced by Gerald Eve and has been independently tested by Carter Jonas on behalf of RBKC.

Further justification for height (and the position of tall buildings) is provided within the ‘Masterplan’ and ‘SPD’ sections of this report.

Generous Open Space

Generous open space has been provided across the masterplan for both public and private use and is conveyed within the landscape section of the Design Code, on the ‘Open Space’ parameter drawings and within the ‘Landscape and Public Realm Strategy’ report which accompany the application.

The masterplan provides the opportunity for a number of key open spaces to emerge, located strategically across the site, both at ground level and on the roofs of buildings:

- Ladbroke Gardens: located at the threshold of the site, provides the opportunity for events, markets, activity and play
- Denby Square: the bustling heart of the masterplan, providing a vibrant arrival point for pedestrians and framed by rain gardens and soft landscape.
- South Terrace: A south facing, car free area of public realm with views across the wider borough. This space provides varied opportunities for play, sensory gardens, along with a connection to the existing retained memorial site, on the south eastern edge of the masterplan.
- Canalside Park: Canalside Park will be built in the first phase of development. The park creates a new green space with play and ecological planting, connecting the new Sainsbury’s with the canal towpath. Features include a new woodland area, 24hr routes through to the canal towpath; a new play space and a new lawn area which capitalises on the serenity of the canal.
- Podium Garden: an expansive open space on the roof of Plot 02 which provides residents of all tenure types with areas for quiet enjoyment, play and activity alongside Orchard & Ornamental Planting and Kitchen Gardens.



Fig 4.50: Varied and vibrant publicly accessible open spaces: Ladbroke Gardens



Fig 4.49: Varied and vibrant publicly accessible open spaces: Canalside Park

4.5.2.9 QRP Response 8:

Recommend reinstating West Drive as a two way road

The diagram adjacent demonstrates the option for integrating West Drive as a two way road.

In order to generate the ability to turn right at the western edge of The Avenue, a roundabout or traffic junction would be required so as not to interrupt the flow of customer traffic to the store. A roundabout in this location would have a significant impact on the public realm in this location due to vehicle turning circle requirements, leading to a vehicle dominated area at the head of The Avenue. A traffic junction was tested here by our Transport Consultant which could not be made to work due to pedestrian and cyclist safety concerns. Bus service vehicle flows would also be negatively impacted by a right turn junction as it would result in vehicles crossing the predominant flow of traffic, resulting in delays to the services.

To deliver a two way road a width of 6m would be required. This would result in a reduction in landscaping to West Drive and would have an impact upon the facade lines of buildings, particularly to Plot 04 and 05, to safeguard sufficient space for pedestrian movement away from the road edge.

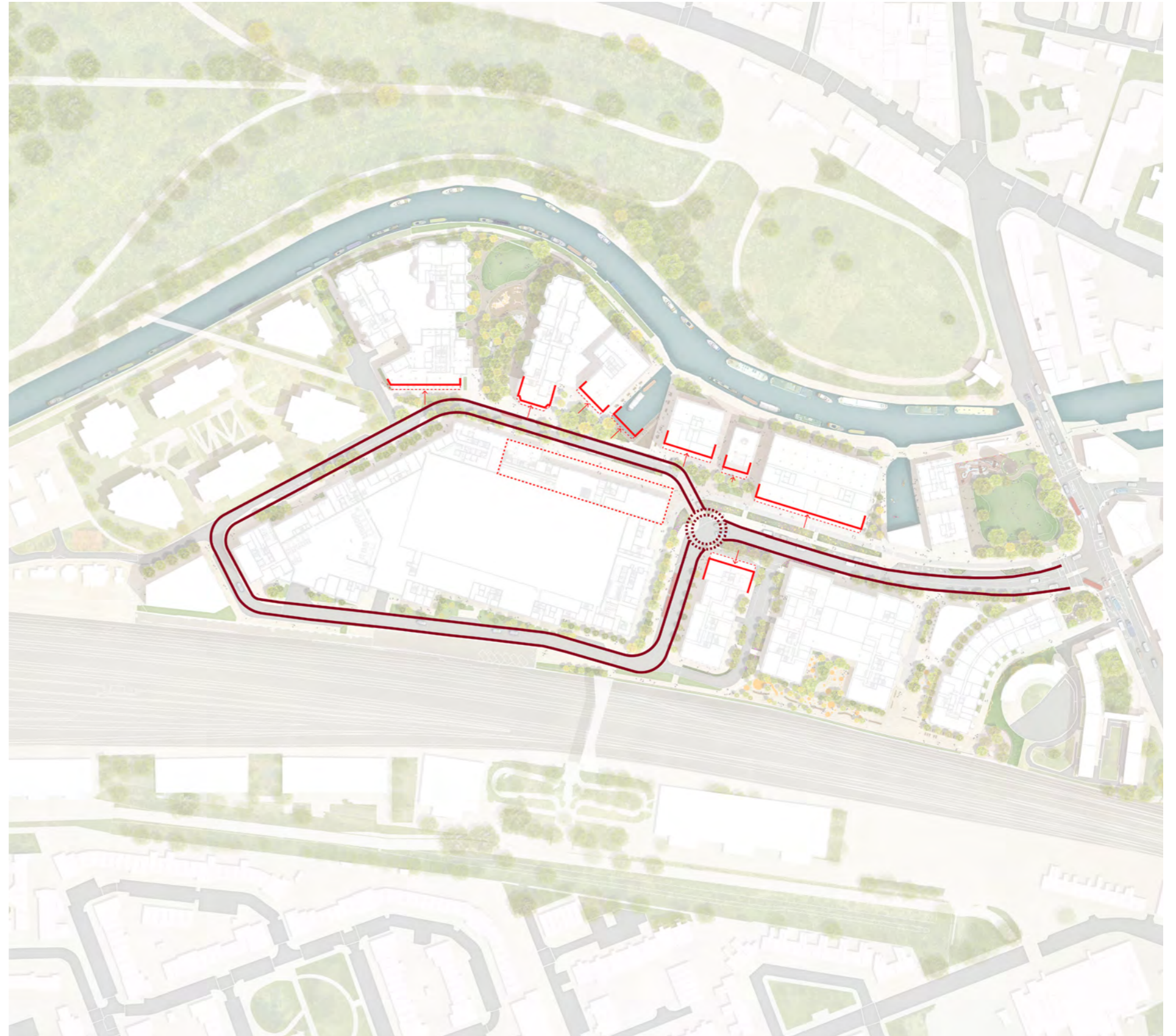

Fig 4.51: Introducing two way roads around Plot 02

4.5.2.10 QRP Response 9:

Plot 2 – further detail on separation distances, defensible space and amenity provision required

This section should be read in conjunction with the parameter drawings, the Plot 02 Design Code and the 'Landscape and Public Realm Strategy' which provide a complete appraisal of Plot 02.

The diagram adjacent illustrates the separation distances between the residential blocks on Plot 02 (dimensions shown relate to the Plot 02 illustrative proposals). A defensible space is provided at podium level adjacent building facades to separate the apartment from the private open space beyond. Residential amenity space is provided where indicated at podium level and on the private balconies.

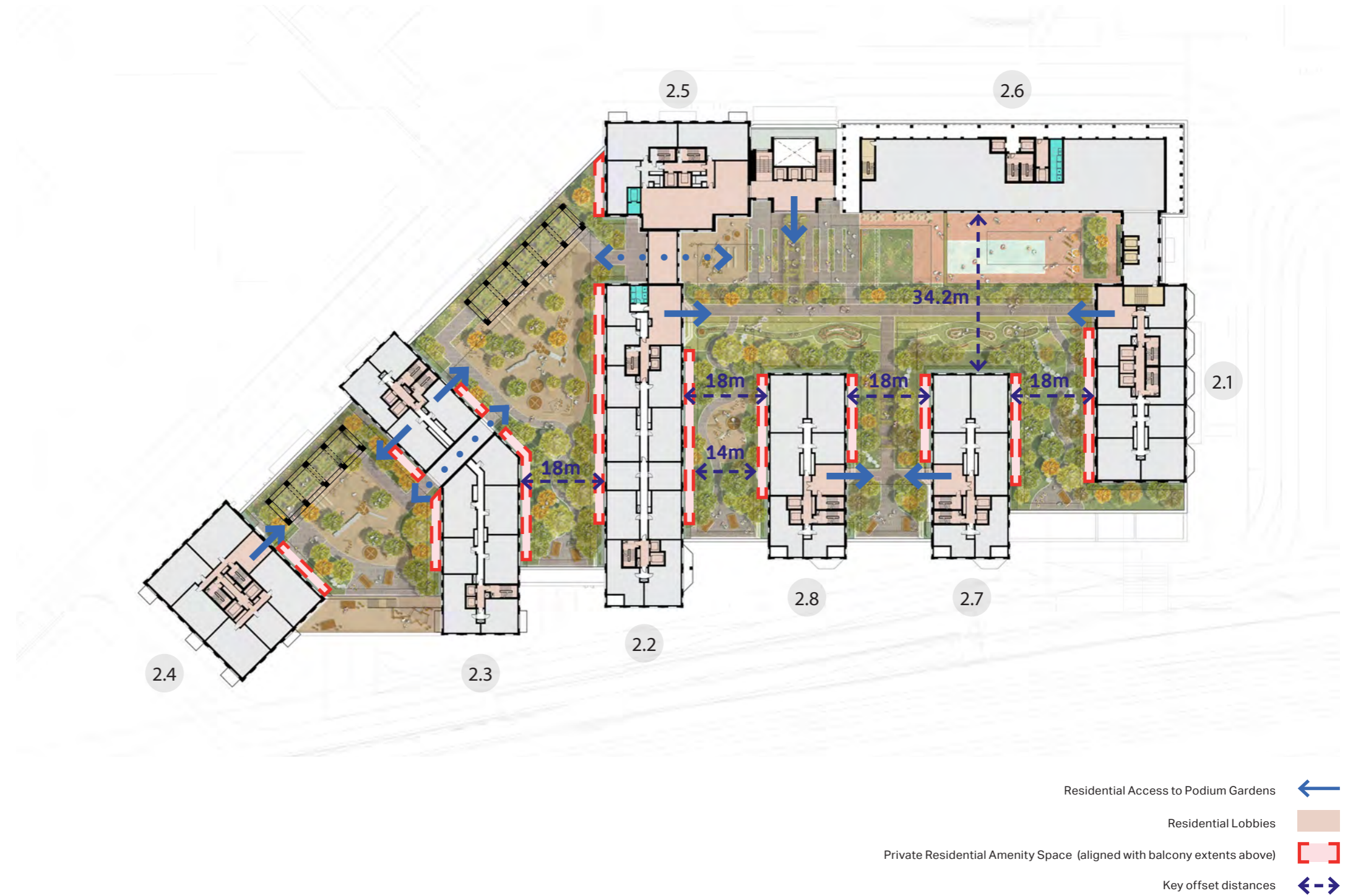

Fig 4.52: Plot 2 - Typical upper level plan

4.6 The Design Teams

4.6.1 Architect Distribution

The site block structure sets the scene for the different development plots within the site. On such a large and complex site, it is always to the benefit of a project to have a team of architects working together to challenge design assumptions made by the masterplan team in the feasibility stages.

The work in this report has been developed since July 2020 with the benefit of input from Hutchinson and Partners and Maccreanor Lavington who are the designers of plots 2 and 4.

Hutchinson and Partners (H+P) history with the site goes back a long way. They have a long-term relationship with Sainsbury's having developed many sites with them across London and the UK. H+P have developed many design iterations for the configuration of the new store at Ladbroke Grove and have been providing input to the masterplan since early 2017. H+P have provided a full chapter on their role and the development of the design for Plot 02 in Chapter 6 of this report.

Maccreanor Lavington (MLA) are renowned as one of the country's leading residential architects. They are experienced in both large scale residential and masterplan design and have completed several recent developments in RBKC. MLA joined the project in July 2020 and are leading the detailed design of Plot 04. The design evolution for Plot 04 is described in chapter 07 of this report.

Practice profiles for both architects have been included at the end of this section.

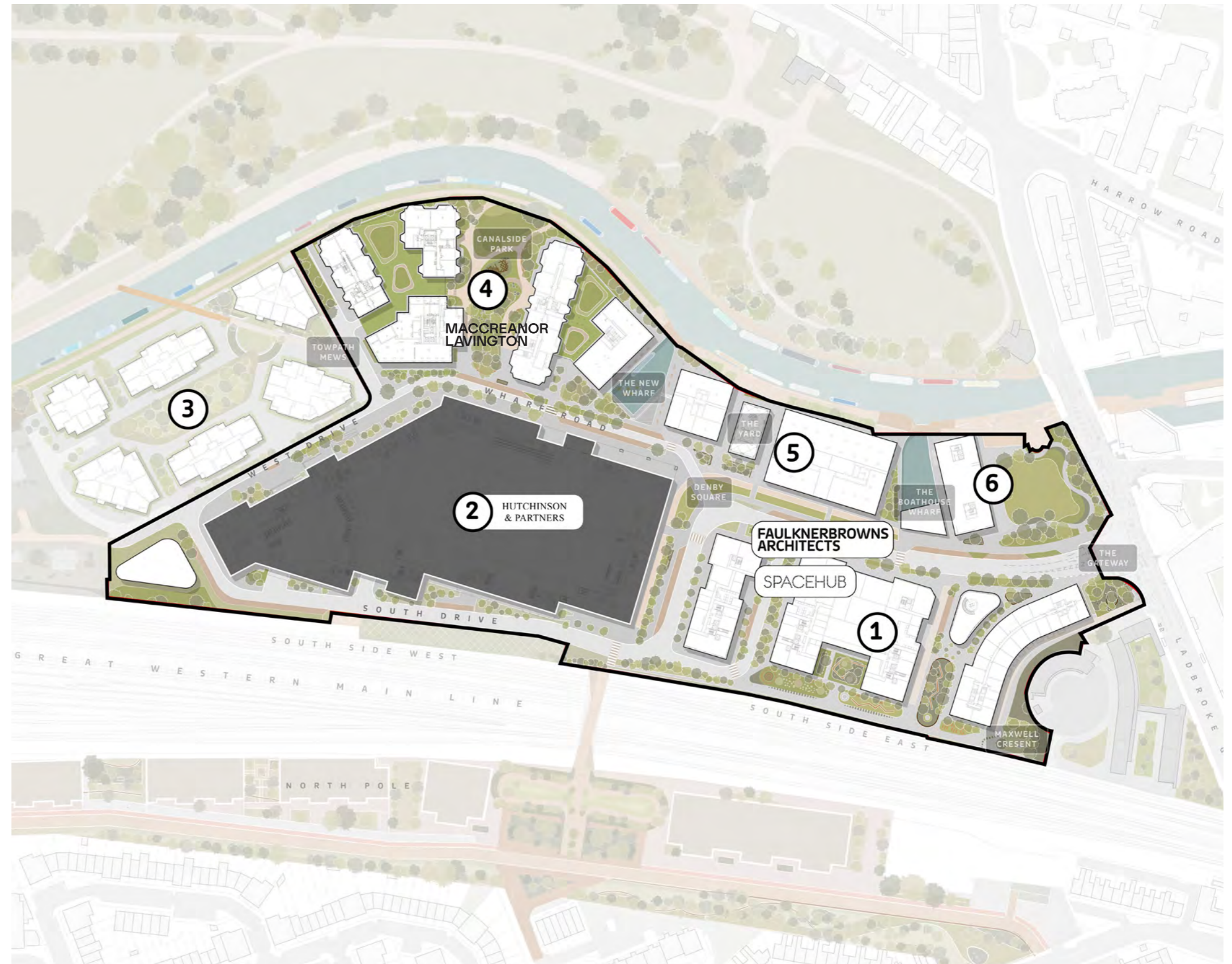

Fig 4.53: The distribution of design team members.

4.6.2 Planning Structure

The planning application will be compiled as a Hybrid Application. Plots 1, 2 (Residential portion) ,4, 5 and 6 will form an outline application, and plots 2 (store) and the main routes through the site will form the detailed application.

Plot 03 will be submitted as a separate planning application as it is owned by Berkeley St William. The masterplan architects (FaulknerBrowns) and the plot architects (Maccreanor Lavington and Hutchinson and Partners) have been working with Berkeley St William and their architects Pilbrow and Partners since October 2020 in order to integrate the masterplan development and the plot 03 design development.



-  St William Owned Land
-  Outline Plots
-  Detail application (Store only)

Fig 4.54: Planning Structure

4.6.3 The Masterplan Architects

4.6.3.1 FaulknerBrowns Architects

FaulknerBrowns Architects is an architectural design practice with studios in the UK and Canada. We have a long-established reputation for designing innovative and operationally successful buildings and masterplans across the UK, Europe, and Canada.

Our projects cover a broad ranges of sectors and are award-winning for exemplary design, community impact, sustainability and functional efficiency. Aspirational architecture that inspires community participation.

4.6.3.2 Working in London / Working for Ballymore

Our role at the Bishopsgate Goodsyrd scheme in LB Tower Hamlets and Hackney has been to lead the masterplan coordination and develop the overall vision for the future redevelopment. Our masterplan was developed in response to challenging feedback the JV received when submitting a denser, less contextually rich proposal in 2015.

Over the last 6 years we have creatively navigated to help the client group achieve their commercial objectives within a finer grain, with more phases but most importantly a greater level of generosity to context and authenticity that resonates with the local community.

We coordinated the whole masterplan preparing concept designs for seven of the buildings including retail, cultural, residential, offices and affordable workspace. We successfully collaborated and coordinated inputs from other exceptional design teams including 5 other architectural practices, landscape designers Spacehub, engineers, and planning consultants.



High level linear park



Brett Wharf - 260 Build to rent 'PRS' homes in central Newcastle

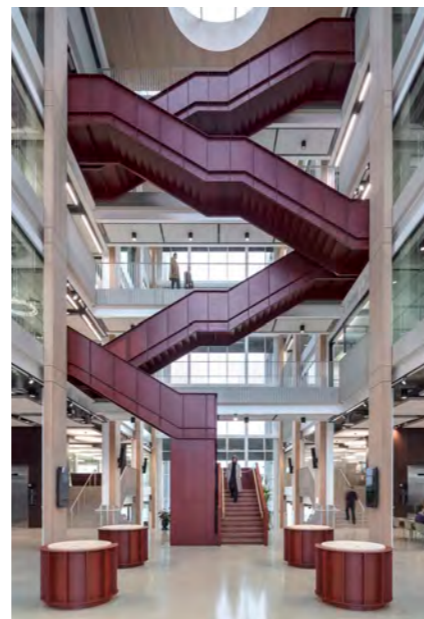

City Hall, Sunderland



A new connecting retail street in the arches

**FAULKNERBROWNS
ARCHITECTS**

4.6.4 Hutchinson and Partners

Hutchinson & Partners

Hutchinson & Partners is an architecture practice with offices in London and Berlin with over 15 years of experience in practice. We are passionate about architecture, urbanism and design; collaborative, explorative and rigorous in our processes; enquiring, understanding, and responsive to the needs of our clients; empathic to the needs of the end user; free-thinking in our research; caring of our people; and determined that the projects we work on leave a positive environmental legacy.

Our design approach seeks to respond to the uniqueness and opportunities of brief, context, legacy and budget with rationalism, simplicity and delight to create enduring places, spaces and buildings, designed with the quality, adaptability and longevity needed for them to be enjoyed by current and future generations to come.

Work Within London

We have experience across many London boroughs, from Camden to Barnet and Tower Hamlets, which has seen us work in sectors including mixed use, residential, workplace, leisure, education, arts, civic, and infrastructure, with projects ranging from London's largest single co-working space all the way through to 700+ unit mixed use projects.



Fig 4.55: Colindale Gardens - Landmark Building



Fig 4.56: Hendon Riverside



Fig 4.57: Silk Park



Fig 4.58: Whitechapel Square

HUTCHINSON & PARTNERS

4.6.5 Maccreeanor Lavington

Maccreeanor Lavington is an award-winning Anglo Dutch architectural practice established in 1992 by Gerard Maccreeanor and Richard Lavington with offices in London and Rotterdam. We have a diverse portfolio and expertise in residential led masterplanning, large scale mixed-use developments, housing, schools, hotels, social infrastructure, retail, and regeneration projects. Our team is made up of exceptionally talented and dedicated people, who have a wealth of knowledge and experience to draw upon.

We are passionate about housing and what it takes to make a great place to live and take pleasure in being involved with long lasting developments that foster positive communities. We have earned a strong and trusted reputation with clients, peers and local authorities and our design work has been recognised with many awards including the RIBA Stirling Prize.



South Gardens, Elephant & Castle, Maccreeanor Lavington Architects

Work within London:

Maccreeanor Lavington Architects have completed a wide range of projects at different scales throughout London, including large residential developments at Blackfriars circus, Elephant & Castle and Kings Cross.

Experience within RBKC:

Maccreeanor Lavington Architects were appointed to the RBKC framework from 2017 to 2020 and have recently obtained planning for St Helens Gardens, a new-build residential scheme replacing a single dwelling from the 1950s with 8 new apartments. We were also part of a collaborative design team working on the recent consultation about the future of the Lancaster West Estate.

MACCREANOR LAVINGTON



Blackfriars Circus, Maccreeanor Lavington Architects

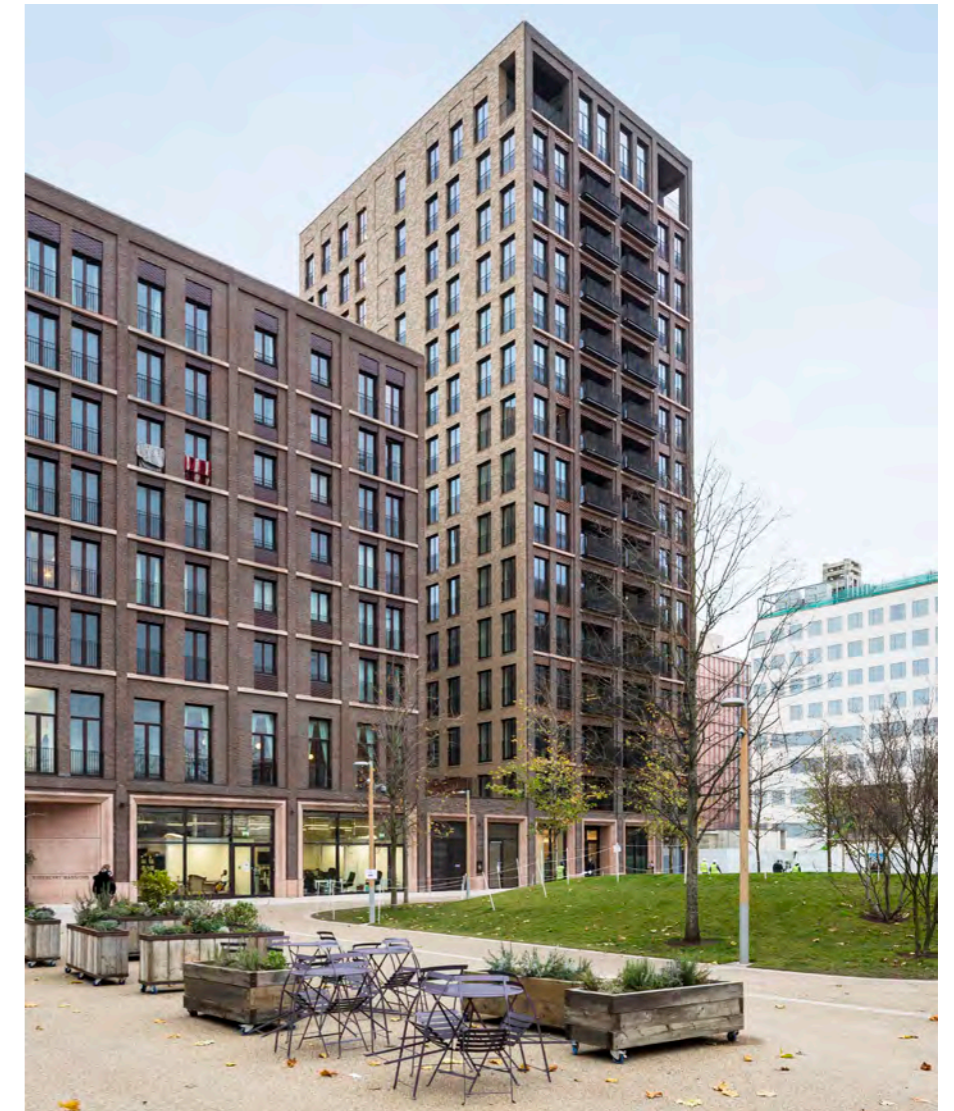

Kings Cross R5, Maccreeanor Lavington Architects



St Helens Gardens, Maccreeanor Lavington Architects

4.6.6 Spacehub

Since their inception in 2010, Spacehub have established a reputation for delivering high-quality designs at a wide range of scales, from major planning applications for developments such as The Goodsyard in Shoreditch to the on-site delivery of prominent public realm schemes such as London Wall Place in the City of London. Based in East London, the practice is led by Giles Charlton and Tom Smith.

Spacehub have developed an ongoing successful relationship with Ballymore which includes the recently completed 'Goodluck Hope' scheme in London as well as Embassy Gardens.



Fig 4.62: Embassy Gardens, London



Fig 4.61: Goodluck Hope, London



Fig 4.59: Goodsyard, Shoreditch

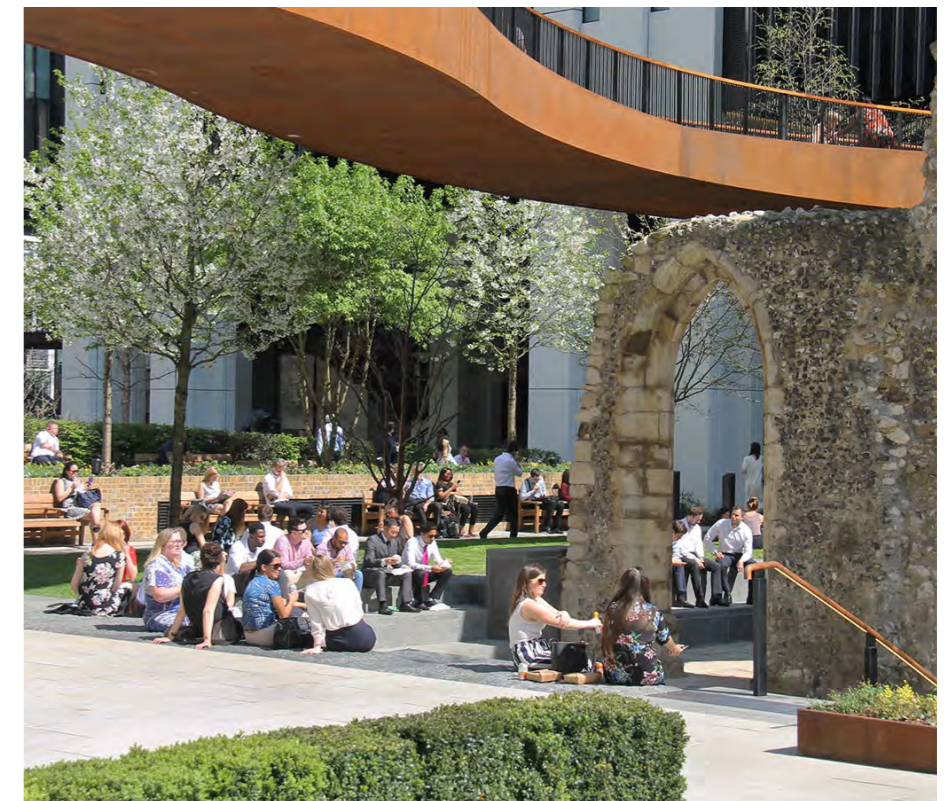

Fig 4.60: London Wall Place

SPACEHUB

This page is intentionally blank

5.0 Masterplan and Plot Overview

5.1	Introduction	143
5.1.1	Overview	143
5.2	The Masterplan - Outline and Detail Elements	144
5.2.1	The Masterplan	144
5.2.2	Landscape Proposals	145
5.3	Sustainability	146
5.2.3	Overview	146



5.1 Introduction

5.1.1 Overview

The following sections explore the design of the plots. The section is sequenced to align with how the masterplan will be phased and constructed. As such, the section begins with the detailed design of Plot 02, followed by the outline designs for Plot 02 and Plot 04. The section concludes with the buildings which will be constructed at a later stage (plot 01, 05 and 06, at the eastern edge of the masterplan).

The following pages illustrate the current masterplan and landscape strategy and convey the subdivision between the outline and detailed elements of the masterplan and plot designs. The section concludes with an overview of the key sustainability considerations.



Fig 5.1: Illustrative Plot 02 Housing and gardens

5.2 The Masterplan - Outline and Detail Elements





Fig 5.2: Illustrative Masterplan showing subdivision between outline and detailed elements

5.2.1 The Masterplan

The current illustrative masterplan is shown above and is comprised over 5 separate plots, Plot 03 lies outside of the application boundary and is owned by Berkeley St. William. The full application boundary is shown in red and the elements of landscape and public realm which are submitted in detail are shown hatched in pink. This area includes all of the principal roads within the masterplan. The new Sainsbury's Store (shown as a dashed green line) is also submitted in detail, while the residential buildings above this are submitted in outline.

All of the remaining buildings and landscape will be submitted in outline. This has been done to provide the necessary flexibility required during the design and construction period, which is likely to take place over the next 10 years. Emerging and draft legislation such as Part B (Fire Safety) and BS9991 (Fire safety in the design, management and use of residential buildings) make this a necessity at this time.



Key:

-  Detail Element of Landscape
-  Detailed Element of Plot 02 (The new Sainsbury's Store)
-  Plot Boundaries

5.2.2 Landscape Proposals

The planning submission is submitted as a 'Hybrid' application, where elements are submitted in both outline and in detail. This subdivision has been shown below. The detailed elements of the landscape encompass the main pedestrian thoroughfare to Plot 02, along the Avenue from the Ladbroke Grove junction, and the principle road network including the bus stops, loading and accessible parking bays across the masterplan.

Key:

-  Detail Element of Landscape
-  Detailed Element of Plot 02
(The new Sainsbury's Store)

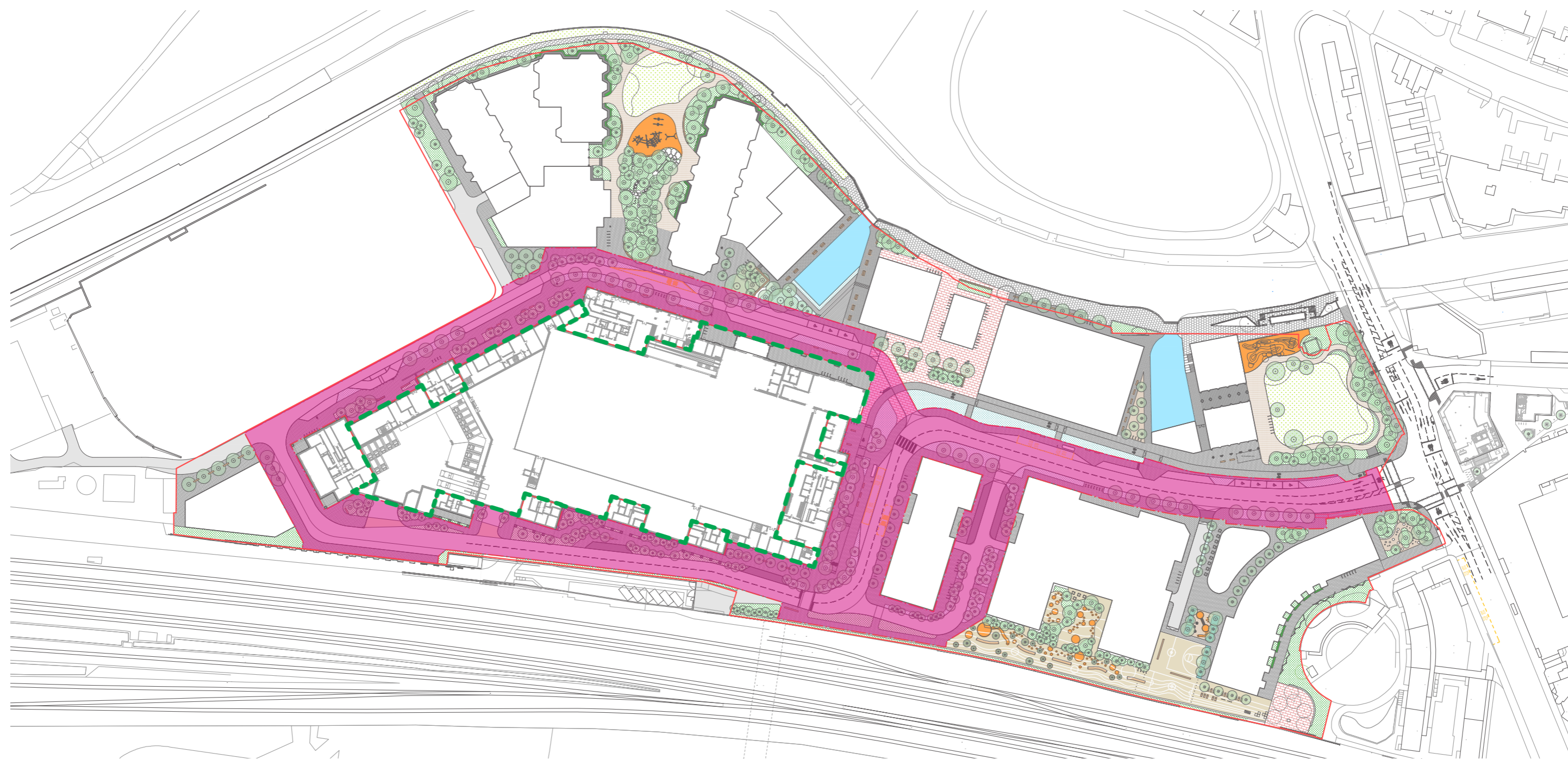

Fig 5.3: Landscape Masterplan showing subdivision between outline and detailed elements

5.3 Sustainability

5.2.3 Overview

The Sustainability Strategy has been produced by Hoare Lea in conjunction with the design team. Hoare Lea have produced a Sustainability Statement, Energy Strategy, as well as carrying out Thermal Comfort Assessments and preparing BREEAM Pre-Assessments for the relevant building uses within the proposals.

The strategy has been informed by national, regional, and local policies – including but not limited to, the National Planning Policy Framework (NPPF), Building Regulations Part L, London Plan Guidance - Circular Economy Statements, the Greater London Authority (GLA) London Plan (2021), the London supplementary planning guidance (SPG) on Sustainable Design and Construction (2014), and the current Royal Borough of Kensington and Chelsea Local Plan (2019).

The strategy is to be read in conjunction with the architectural drawings. Any recommendations within the reports are subject to discussion and approval by the Statutory Authorities. Full details can be found within these reports which accompany this application. The following page highlights the key design moves and technologies proposed across the masterplan.

As a summary, planning policy documents applicable to the Proposed Development have been identified and include the below listed:

- National Planning Policy Framework (2021)
- National Building Regulations (2021)
- The London Plan (2021)
- RBCK Local Plan (2019)
- RBKC Greening Supplementary Planning Document (2021)

- Kensal Canalside Opportunity Area SPD (2021)

Key targets from these documents are summarised below:

- Site layout and sustainable design principles to reduce energy demand and increase efficiency.
- A minimum on-site reduction of at least 35 percent beyond Building Regulations 2021 Part L for major development.
- Non-residential development meets BREEAM at least Very Good standard with 60 per cent of the unweighted credits available in the energy, water and materials sections.
- Applicants for major development should undertake and submit a whole life-cycle assessment and circular economy statement.

Where it is clearly demonstrated that the zero-carbon target cannot be fully achieved on-site, any shortfall should be provided, in agreement with the Borough, either through a cash in lieu contribution to the Borough's carbon offset fund, or off-site provided that an alternative proposal is identified, and delivery is certain.

In many cases the Proposed Development goes beyond these requirements.

The wider sustainability considerations across the development include:

- Wildflower grassland and open mosaic habitat roofs to accommodate Photovoltaic panels where appropriate
- Air Source Heat Pumps provided at roof level on buildings
- Green and Blue infrastructure such as raingardens positioned along The Avenue within the masterplan
- Active travel incentivised through dedicated cycle routes and wide pavements for pedestrians
- Dedicated cycle parking provision to all buildings, for both residential and commercial use and allowing for standard, accessible and cargo bike storage.
- Generous provision of public and private open space incorporating play opportunities
- Access to public transport network within close proximity to all residential entrances
- Use of sustainable and robust materials within the building fabric to ensure longevity
- Biodiverse landscape and roofscapes implemented to ensure existing ecology is safeguarded

In alignment with policy requirements the development will:

- The Proposed Development is anticipated to achieve up to a 60.10% carbon emission reduction, compared to the required Part L 2021 notional baseline.
- Fabric First Approach has been taken across the site, where a balance between natural daylighting and limiting overheating has been sought.
- Low Space heating demands by employing low U and G values within the facades.
- Natural ventilation is to be promoted where possible. High efficiency, low energy consumption localised mechanical ventilation with heat recovery (MVHR) systems will be used where this is not possible.
- Where possible, cooling will be achieved through openable windows. Where this is not possible due to local air quality and noise levels, cooling will be provided through mechanical means.
- The Proposed Development will seek to re-use elements from demolished buildings where appropriate, as described in Section 3 of this report.
- The Proposed Development will feature water efficient fixtures and fittings.
- The benefits of natural daylight have been maximised across the development and low energy light fittings have been utilised.
- Limit greenhouse gas emissions in operation and minimise both annual and peak energy in line with London Plan Policy SI 2

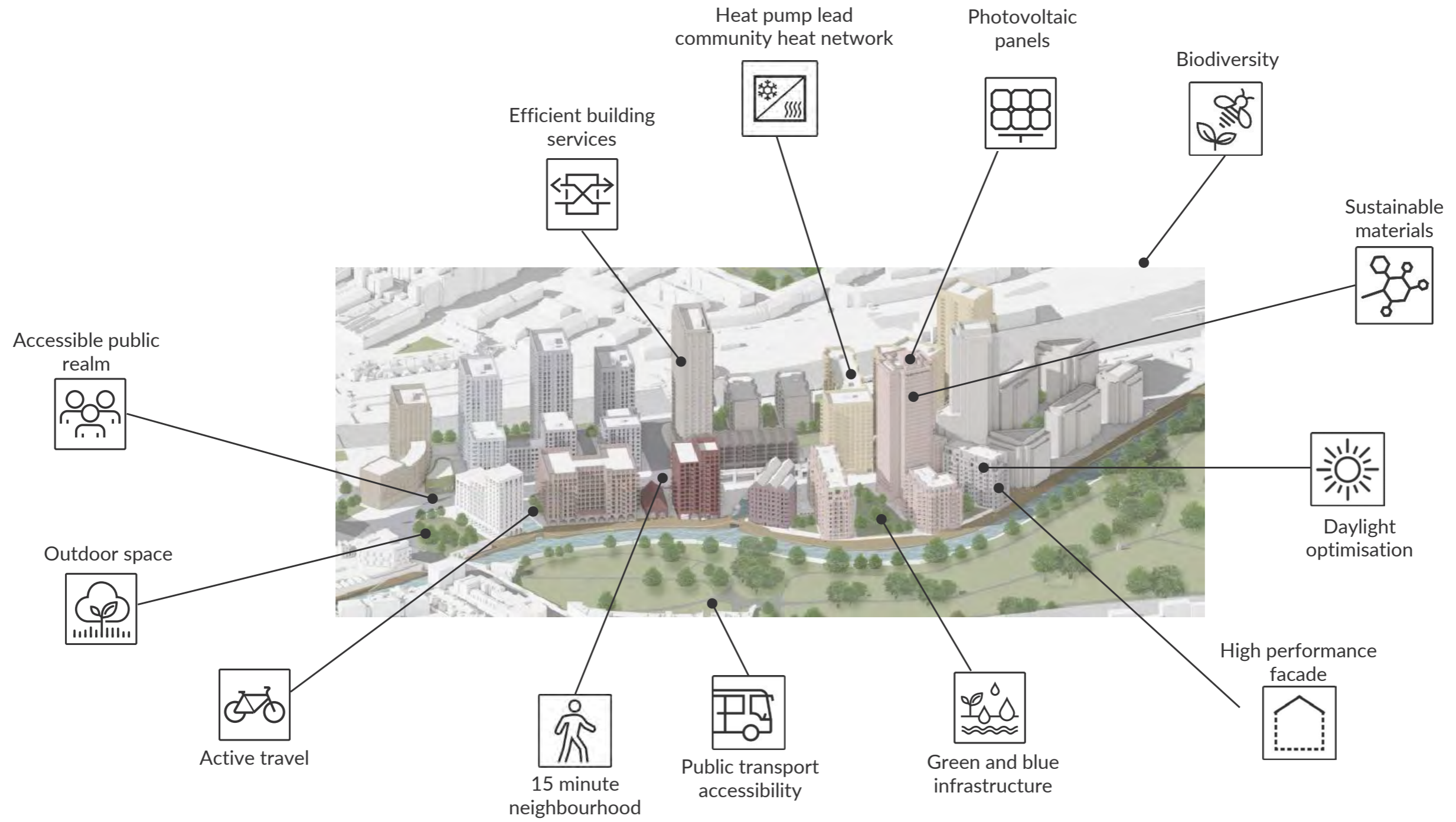

Fig 5.4: Illustrative scheme - Sustainability Principles

6.0 Detailed Proposals - Plot 2

6.1 Introduction 158

- 6.1.1 Overview 158
- 6.1.2 Connection to the masterplan 158
- 6.1.3 Height & Massing 159
- 6.1.4 Detailed & Outline Elements 160

6.2 The Store 161

- 6.2.1 Overview 161
- 6.2.2 Existing & Proposed Store 162
- 6.2.3 Store Layout 163
- 6.2.4 Servicing 164
- 6.2.5 Store Frontage 165
- 6.2.6 Materiality 166
- 6.2.7 Narrative 167
- 6.2.8 Entrance Plan 168
- 6.2.9 Section 169
- 6.2.10 Elevations 170
- 6.2.11 Scale & Appearance 171
- 6.2.12 Store, South Drive 174

6.3 Podium Buildings 177

- 6.3.1 Overview 177
- 6.3.2 Podium Buildings Layout 178
- 6.3.3 Residential Estate Management 179
- 6.3.4 Commercial Space, West Drive 181
- 6.3.5 Commercial Space, The Avenue & South Drive 183



Plot 02, which includes the new Sainsbury's Store, is a key part of the proposed development and forms the focal point at the end of the new high street, guiding people into the heart of the masterplan.

The plot is comprised of the new store, high quality homes including various tenure types and a private garden space on the roof of the store, inspired by the Kensington gardens prevalent across the borough. Complementary commercial uses then frame the remaining frontages at ground floor level, to encourage pedestrians to interact with the building on all aspects.

Plot 02 is purposely designed so that it does not read as a single entity, but rather a group of distinct elements inspired by the character of the borough. This principle serves to reduce the visual scale of the overall building. Regency housing, which typify parts of the borough, the sites industrial and canalside heritage and the history of Sainsbury's itself all play thier part in giving Plot 02 a distinct identity and a varied composition, allowing it to integrate into the wider masterplan.

6.1 Introduction

6.1.1 Overview

The Plot 2 design proposals have been prepared by Hutchinson & Partners, in conjunction with the wider consultant team identified earlier in the Design & Access Statement, on behalf of Ballymore (London Arena) Limited and Sainsbury's Stores Limited (the Applicant). The following chapters describe the design for Plot 2 of the proposed redevelopment at the Sainsbury's and Former Utilities Land, Canal Way, Ladbroke Grove, London, W10.

As part of the hybrid application, the residential buildings that form the Outline element on Plot 2 have been developed and co-ordinated with the Detailed element for the lower levels of the site. This includes the Sainsbury's store and its ancillary spaces including plant, parking, and service yard. The Detailed element also includes the Plot 2 basements which include residential ancillary spaces such as plant, cycle stores, and car park. Two commercial spaces in between the residential buildings complete the lower levels and the extent of the Detailed elements.

6.1.2 Connection to the masterplan

Plot 2 sits at the south-west of the masterplan. The layout and massing has been informed by its relationship to the surrounding plots, ensuring that the opportunities of the site are optimised whilst not compromising the quality of the spaces within and around the plot.

Bound by the railway to the south, this provides the opportunity to vary the height of the residential buildings along the southern boundary, creating a varied skyline when read in conjunction with Plot 1 without overshadowing the existing neighbourhood to the south.

Lower buildings are proposed to the northern edge of Plot 2, located in the heart of the masterplan, ensuring that daylight and sunlight to the proposed new public realm to the north, including Canalside Park and the New Wharf, are not compromised.

The potential opportunity for a pedestrian and cycle bridge over the railway lines to the south has been integrated into the emerging proposals for Plot 2, ensuring that a legible and accessible route is provided, running in a north-south orientation between Plots 1 and 2, providing a route into the centre of the emerging neighbourhood. A generous pavement and dedicated cycle lane will connect the future bridge landing through the masterplan along The Avenue and back on to Ladbroke Grove to the east.



Fig 6.1: Plot 2 within the proposed masterplan

6.1.3 Height & Massing

Plot 2 places a number of buildings in key gateways within the wider masterplan. The distinct form and massing of each building has been developed in response to its function and context.

One of the tallest buildings within the masterplan, Building 2.1 is located in the heart of the site, on the eastern edge of Plot 2. This acts as a visual marker for the new store within the wider context. This residential building has a generous entrance lobby activating the new street, and is flanked by a mixture of commercial and leisure uses to provide a diverse range of activity at street level.

To the north of Building 2.1, is Building 2.6. Visible on the main approach from Ladbroke Grove, and contrasting in scale and architectural style, the building celebrates the end of The Avenue. The distinct base of the building denotes the Sainsbury's store entrance, whilst the Leisure Facilities also activate the building frontage above the store. The building continues along West Drive, providing a distinct backdrop to the New Wharf.

Continuing along the north, Building 2.5 acts as a backdrop to Canalside Park on Plot 4 as well as signifying the kink in the road along West Drive.

At the western end of the site, Building 2.4 book-ends the proposals on Plot 2. With community space at street level, the building provides a backdrop to the proposed Sports Centre to the west.

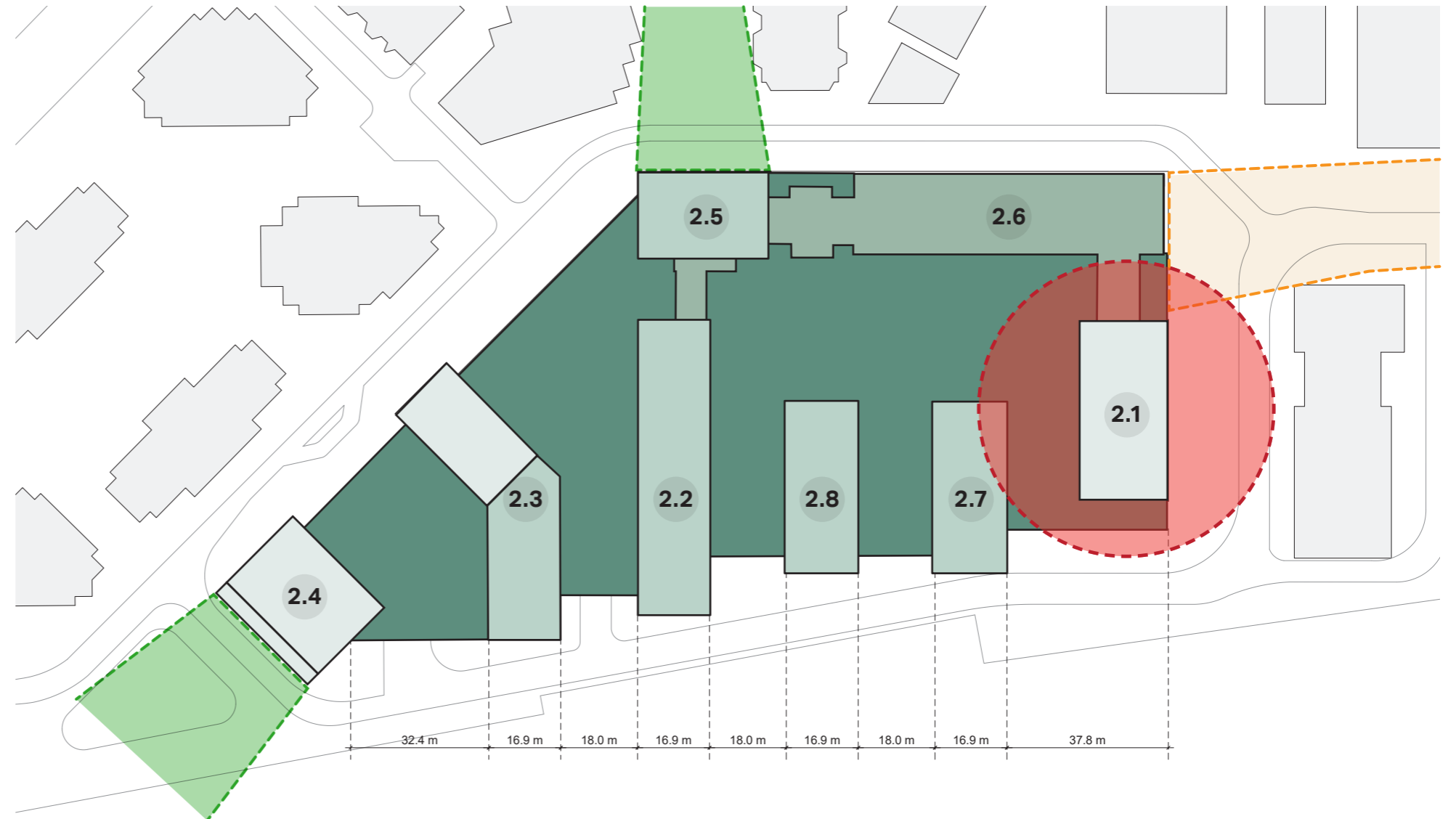

Fig 6.2: Block Gauging

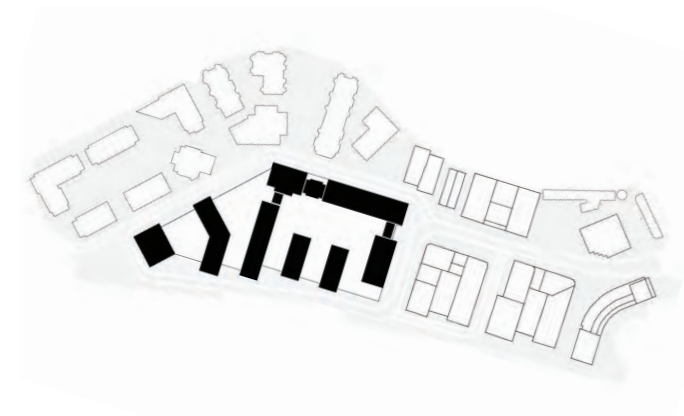
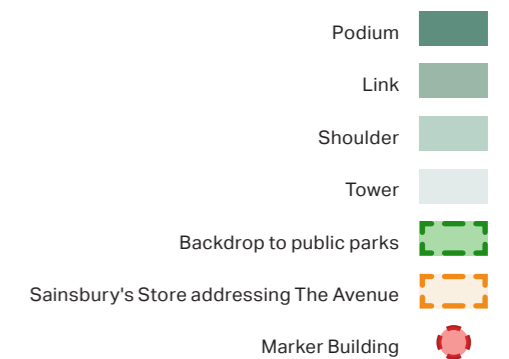

Fig 6.3: Illustrative scheme



6.1.4 Detailed & Outline Elements

As part of the hybrid application, the residential buildings that form the Outline element on Plot 2 have been developed and co-ordinated with the Detailed element for the lower levels of the site.

The lower levels, highlighted in Figure 1.4 and 1.5, includes the Sainsbury's Store and its ancillary spaces including plant, Car Park, and Service Yard. The Detailed element also includes the Plot 2 basements which include residential ancillary spaces such as plant, cycle stores, and car park. Two commercial spaces in between the residential buildings complete the lower levels and the extent of the detailed elements.

The diagrams also identify the eight residential buildings proposed as part of the Outline element of the scheme. Whilst the footprint of the proposed Sainsbury's store expands across Plot 2, the proposed residential buildings line the perimeter of the plot, breaking down the massing and responding to the neighbouring plots.

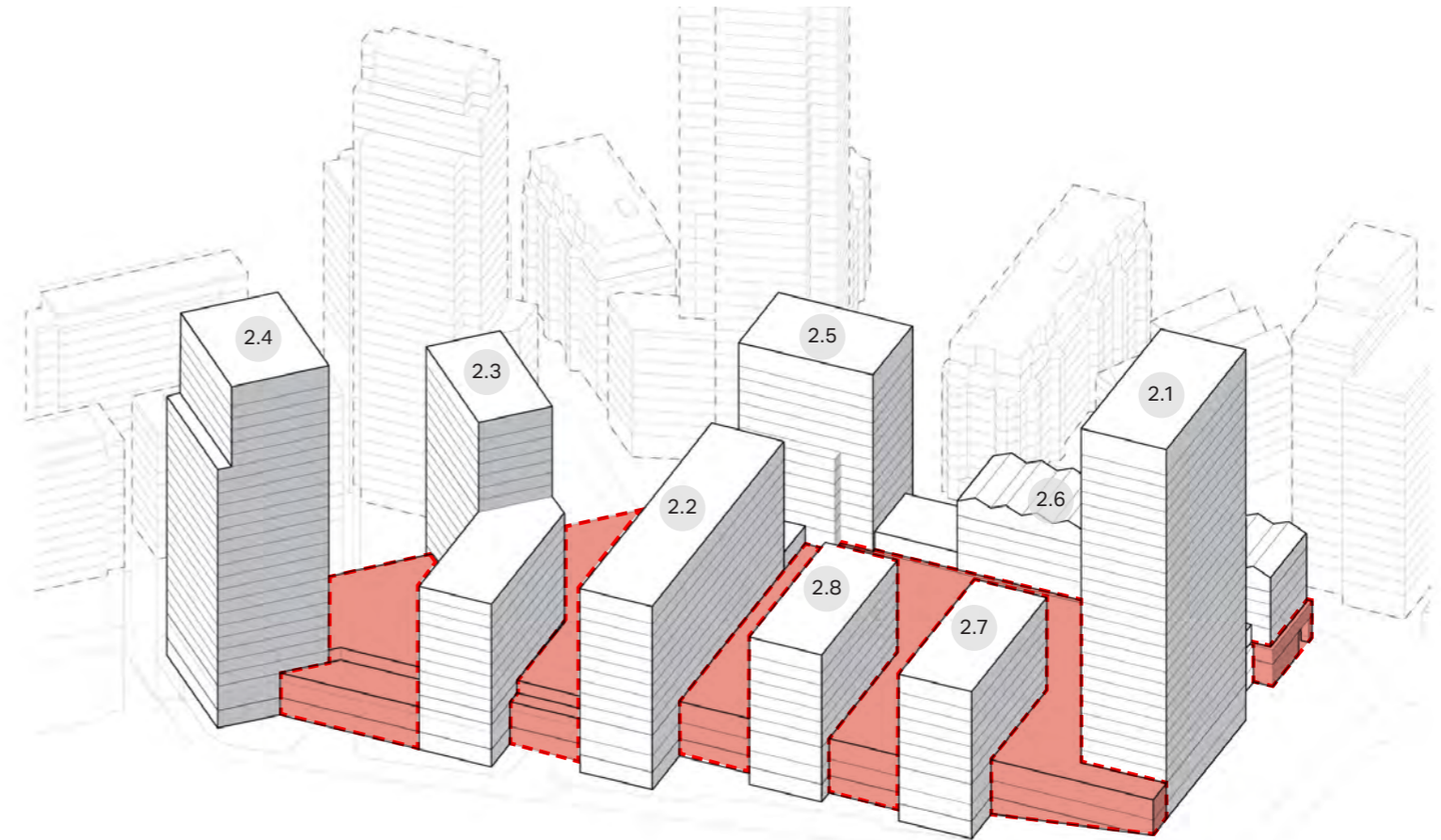

Fig 6.4: Massing concept diagram, View from South East

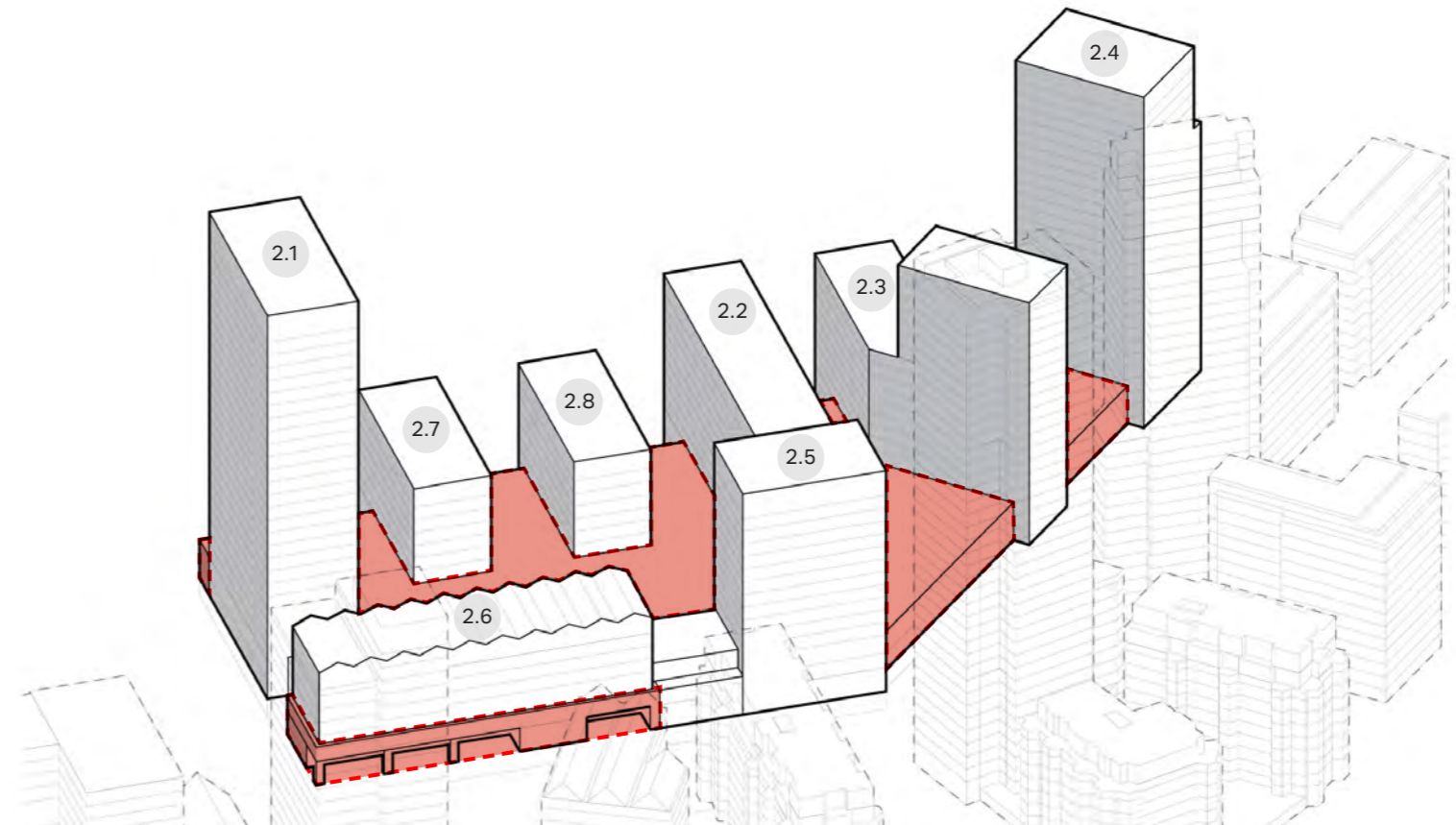



Fig 6.5: Massing concept diagram, View from North East

Extent of Detailed Element 

6.2 The Store

6.2.1 Overview

This section outlines the proposed appearance, layout and materiality of the Store on Plot 2. This has been arrived at through careful consideration of the existing and proposed context, as well as the proposals for the Outline elements, including Building 2.6 located above the Store Entrance and the other residential buildings on the site.

The layout and massing of the Store entrance is intrinsically linked to the building above, ensuring that the form and colour palette pay homage to the location at the intersection of Ladbroke Grove and the Grand Union Canal, as well as the sites industrial heritage. The proposed Store entrance aims to balance, complement, and dignify the surroundings, providing a backdrop against which the development can flourish.

The pitched form of Building 2.6 is informed by the industrial warehouse typologies of the former gasworks on the site. The building sits on top of a glazed ceramic plinth which forms the entrance to Sainsbury's. The generous scale and strong form signify the importance of the Store entrance on the site and responds to the new public spaces beyond, the New Wharf to the north and the wide boulevard of The Avenue to the east on the approach from Ladbroke Grove.

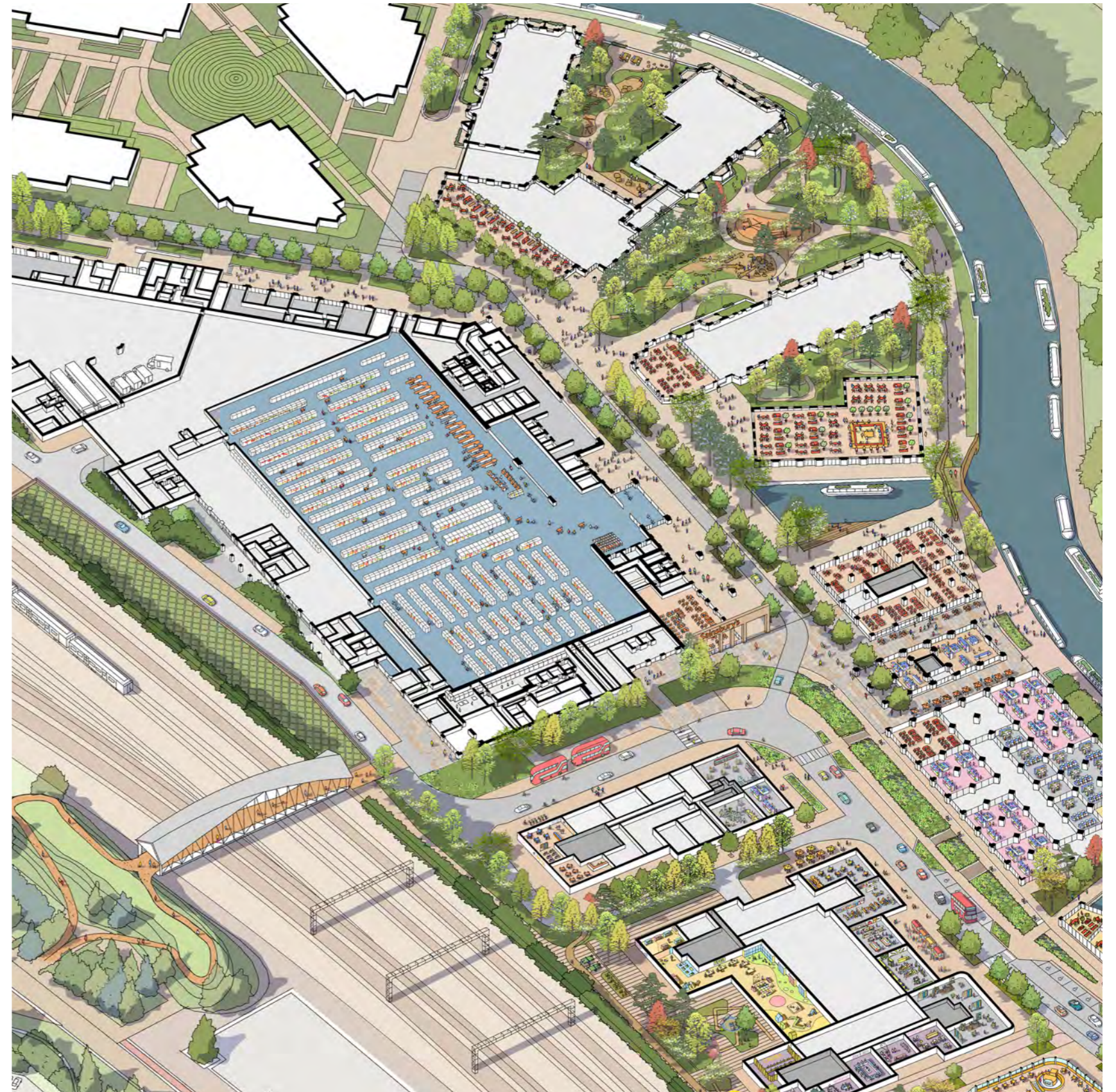

Fig 6.6: Axonometric sketch showing relationship of Plot 2 to masterplan

6.2.2 Existing & Proposed Store

The existing Store opened in March 1988; a purpose-built supermarket located on the eastern end of the site.

The single storey building is fronted by a large surface level car park, providing 396 parking spaces, as well as an 8-pump petrol filling station. The site is dominated by vehicular access. A roundabout on Ladbroke Grove provides access to the Store car park and filling station, as well as access to the rear of the site along the southern boundary.

The existing store has limited aisle widths which makes it less suitable for online shopping and the method by which goods are picked and delivered. The land-take is significant given the limited store size with much of the plot dominated by vehicle parking. The existing store's location in turn makes surrounding development challenging and retention would lead to a compromised entry sequence into the site for new residents. Relocating the store provides the opportunity to provide new homes above the store which would not be possible with the existing building.

The proposed location of the new Store within Plot 2 allows for the construction work to be phased in order to provide continuity of trading from the existing Store to the new Store.

Plot 2 currently houses parking areas and portable cabins within the former gasworks complex and the existing Network Rail compound.

Existing Store

Store GIA: 8,823 m² / 94,970 sqft
Service Yard (External): 946 m² / 10,183 sqft
Car Park (External): 396 Spaces
Goods Online: 5 Vans
Petrol Filling Station: 8 Pumps

Proposed Store

Store GIA: 13,341 m² / 143,601 sqft
Service Yard GIA: 1,620 m² / 17,438 sqft
Car Park GIA: 7,994m² / 86,047 sqft
Car Park Spaces: 227 Spaces
Goods Online: 15 Vans
Petrol Filling Station: N/A

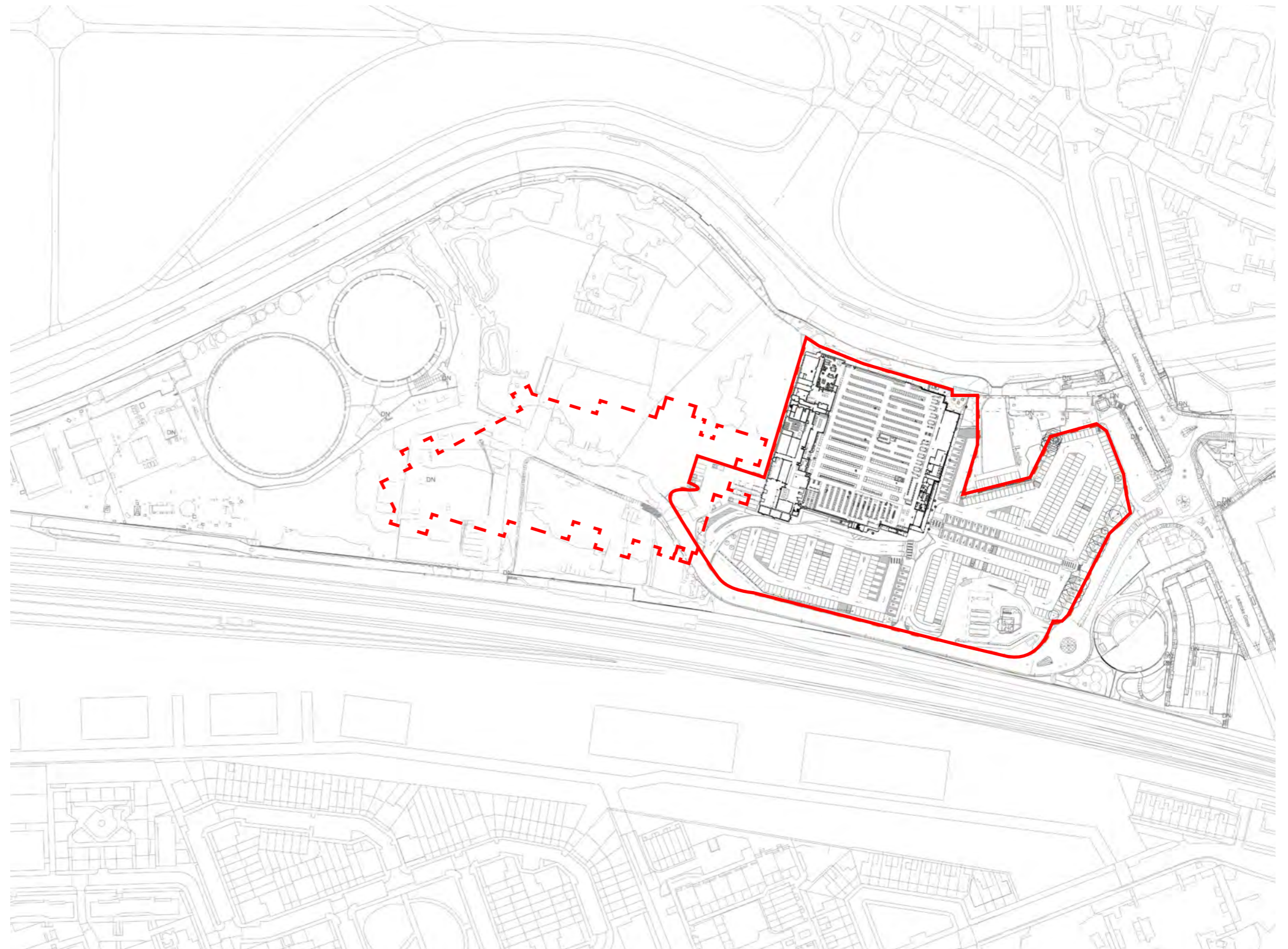
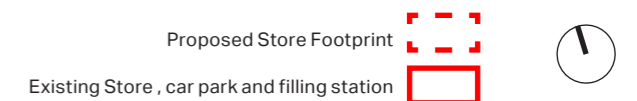

Fig 6.7: Site Plan 1:2500



6.2.3 Store Layout

The proposed Store is located on Plot 2 to enable the existing store to continue operating whilst the new store is constructed. This ensures the continuity of trading throughout the development of the site.

The proposed store is located at street level with a generous new entrance on West Drive, opposite the New Wharf, to the north of Plot 2. A wide colonnade extends across the front of the store and towards the bus stops on The Avenue. This also provides sheltered short-stay cycle provisions for customers and ATMs. A dedicated vehicular pick-up point is also provided in front of the entrance.

Internally, the entrance accommodates trolley bays as well as lifts and travelators to the customer car park located at Basement level. Additional cycle storage is also provided at Basement level for staff and customers. Refer to the Technical Considerations for details of the proposed parking provisions.

The trading area, indicated in blue on Figure 1.7, will offer the same range of goods as the existing store, including Argos and the reprovision of a cafe, located on the corner of West Drive and The Avenue. The overall area is larger due to the provision of wider aisles, providing an improved shopping experience and accommodating additional staff for online shopping services.

The ancillary spaces including Back of House, Service Yard, Means of Escape, and Plant, indicated in grey, are more discreetly located in the centre of the plan. The perimeter of these spaces is wrapped with other uses including commercial, residential and community spaces, to ensure the street frontages are activated with a diverse range of uses.

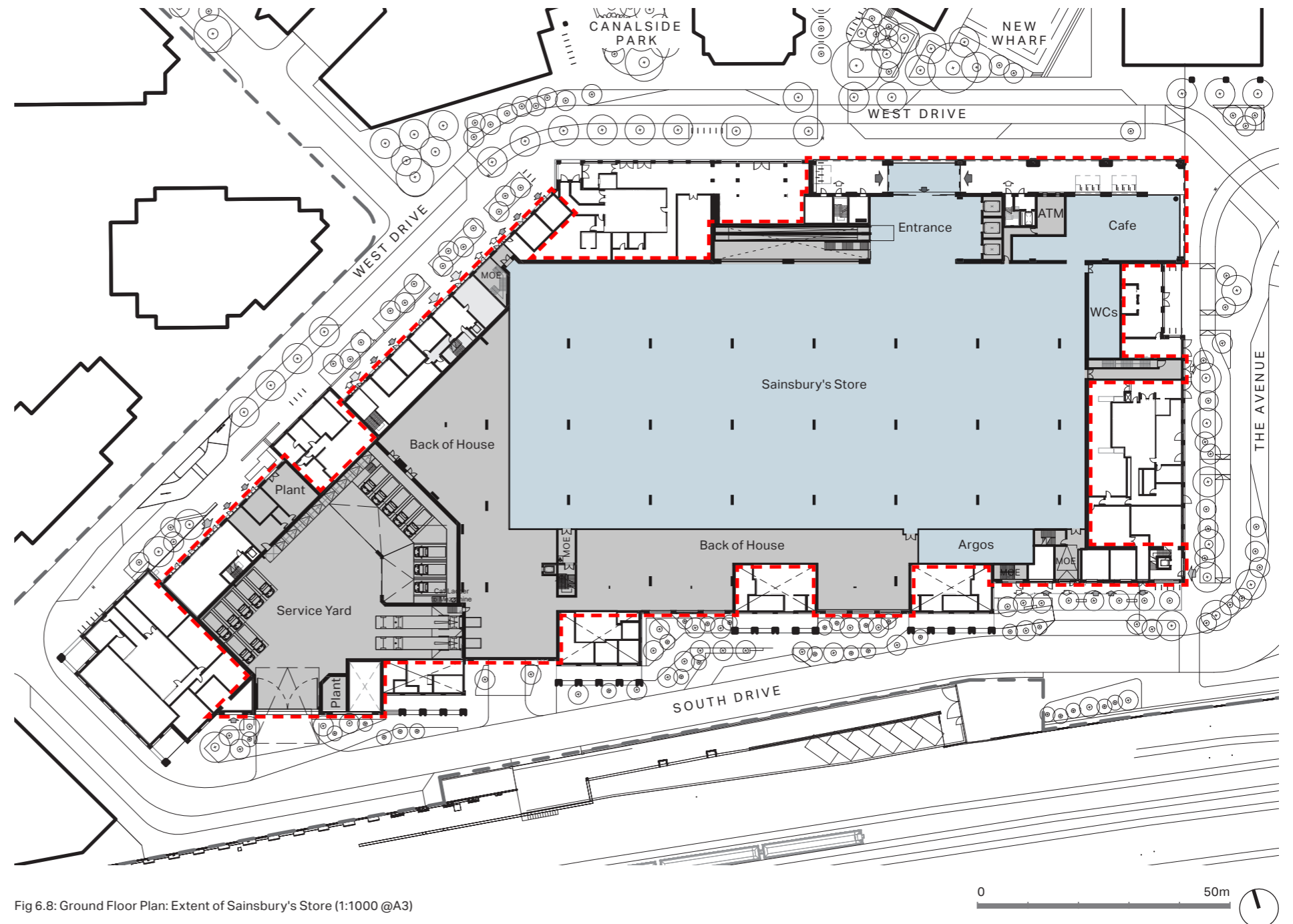

Fig 6.8: Ground Floor Plan: Extent of Sainsbury's Store (1:1000 @A3)

- - - Extent of Detailed Element
- Store Trading Area
- Store Ancillary Spaces

6.2.4 Servicing

The Sainsbury's Store will be serviced via a dedicated internal Service Yard located on the ground floor to the south-west of Plot 2.

Accessed from South Drive, via The Avenue from Ladbroke Grove, the Service Yard can accommodate two large-scale vehicles for deliveries as well as 15 delivery vans for online shopping. All transport provisions and routes have been developed by the Transport Consultant, WSP.

The Sainsbury's Store is envisaged to be zero-waste. Bins will be located within the Service Yard, where it will be managed to the appropriate facility. As the Local Authority does not collect commercial waste, all commercial users will be required to arrange private collection via a separate provider. Waste provisions have been assessed by WSP.

Further details can be found in the Transport Assessment and Waste Management Strategy that accompany this application.

Appropriate acoustic measures will be taken to ensure that there will be no disturbance from the Service Yard to residents of the development.

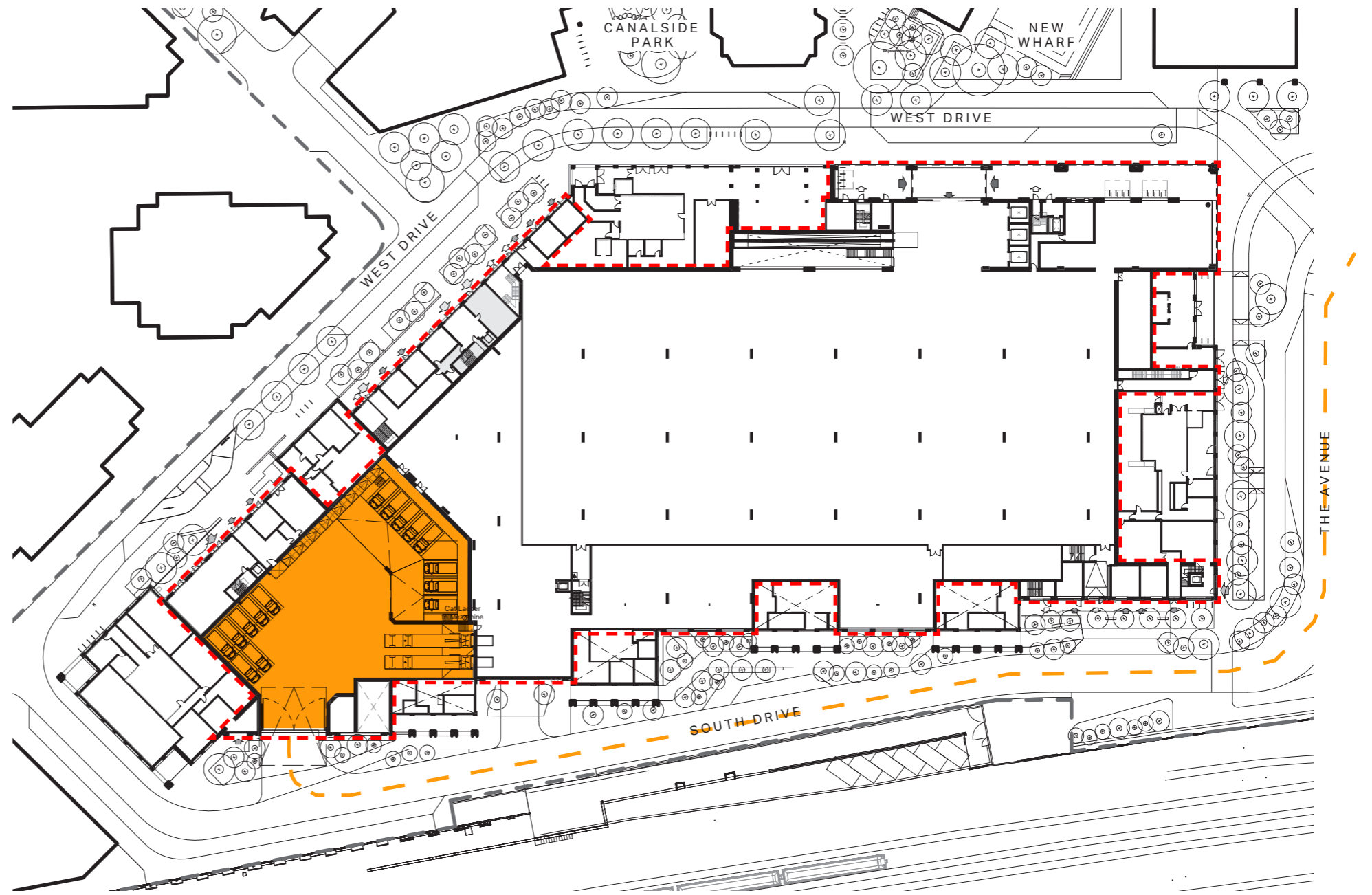

Fig 6.9: Ground Floor Plan: Store Servicing Strategy (1:1000 @A3)



- - - Extent of Detailed Element
- Service Yard
- - - Vehicular Route

6.2.5 Store Frontage

Whilst the layout of Plot 2 aims to discreetly integrate the new Sainsbury's Store within the mixed-use proposals, it is critical that the Store frontage is visible and clearly legible to customers.

The key below indicates the store frontage signifying the main entrance.

Since the opening of their first shop in Drury Lane in 1882, the presence of Sainsbury's shopfronts and signage have played a significant role in establishing the brand. Their shops quickly started to look similar with high, cast-iron 'J.SAINSBURY' signage featured on every Store, in order for people to recognise them throughout London and see them from afar.

The precedent studies shown, illustrate the key components to forming a successful, robust, and clearly identifiable shopfront. These components have informed the detailed design of the colonnaded Storefront addressing The Avenue and West Drive. The scale of the components aims to introduce a more human scale to the building at street level whilst clearly identifying the entrance to the Store. Breaking down the facade as illustrated also provides defined spaces for the Store's signage.



- Cornice
- Recessed Fascia
- Pilaster
- Plinth

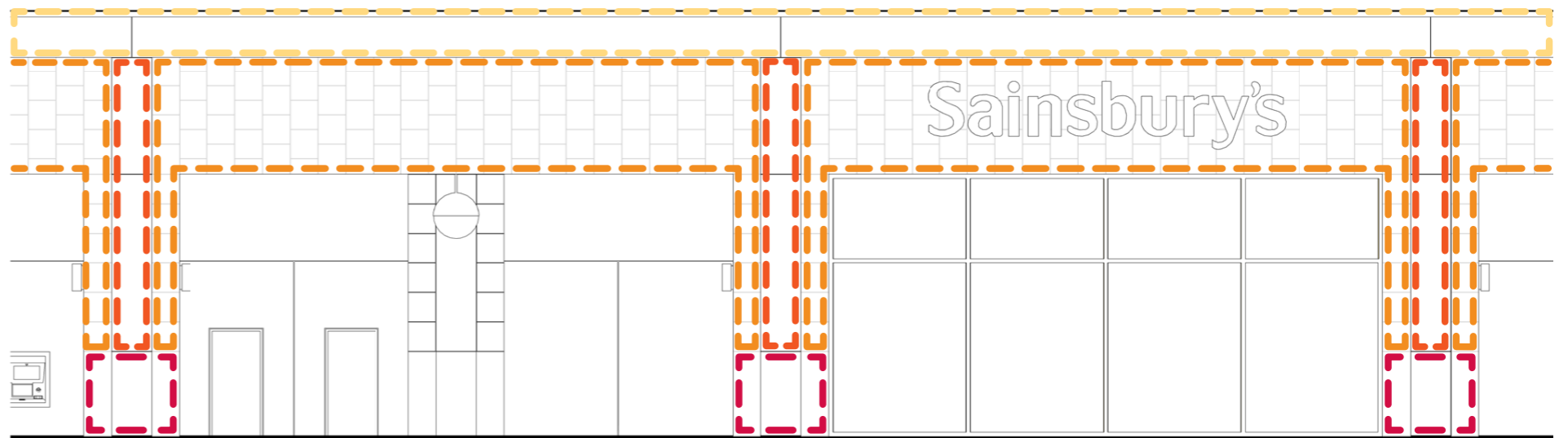
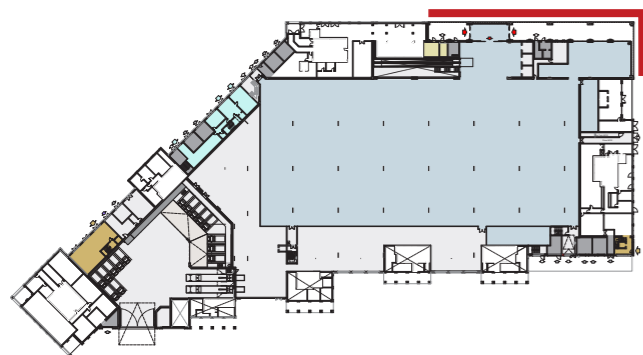

6.2.6 Materiality

The Store front is distinguished at street level by the introduction of a colonnade. The colonnade extends the arrival point to the entrance, forming a connection to the drop-off point on the West Drive and the bus stop on The Avenue, as well as forming the base to the Building 2.6 above.

In contrast to the other buildings, it is proposed to introduce the use of off-white glazed faience to define the colonnade and provide a backdrop to the Store signage. The use of this material aims to define the grander scale from afar, whilst the detail and setting out introduce a more human scale when viewed up close, as well as adding texture and depth to the finish, reminiscent of the glazed tiles commonly used in Victorian shopfronts.

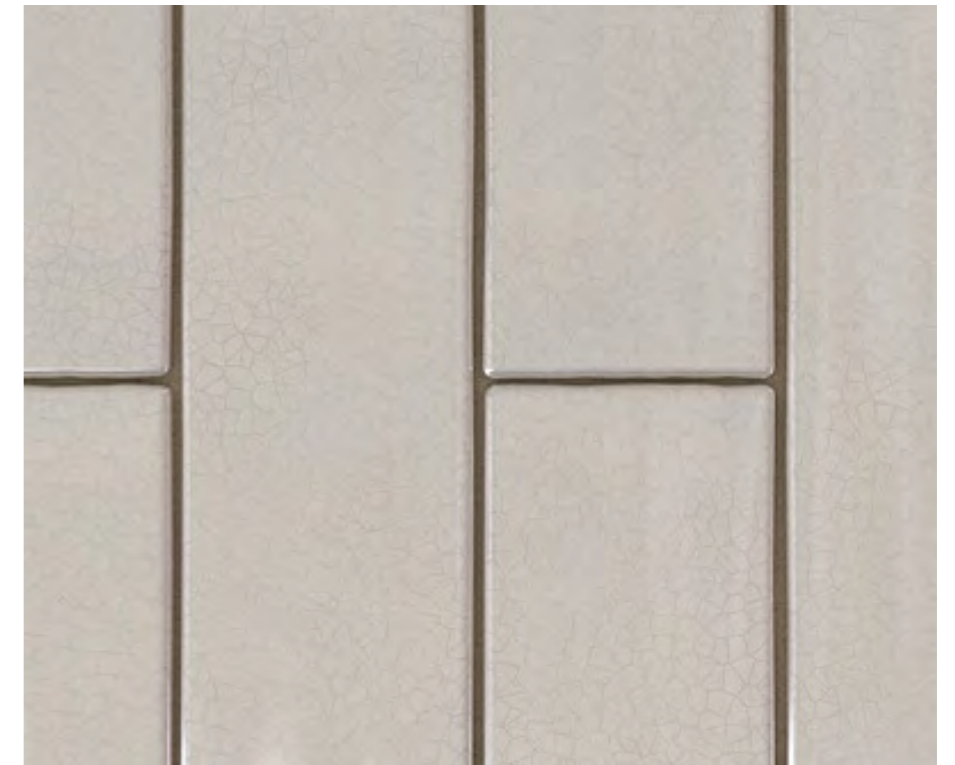

6.2.7 Narrative

The illustrations below show the key design characteristics of the Store frontage in diagrammatic form. This represents the visible presence of the Store within the masterplan. The diagrams include the outline of Building 2.6 above, which forms part of the Outline element of the scheme. The rhythm of the store colonnade and its relationship to the building above identify the important duality of both components. Combined, the massing forms a long linear block running in an east west orientation, in contrast to the other residential buildings proposed on Plot 2, signifying the importance of this end point of the north-east corner of Plot 2.

The first diagram illustrates the importance of the east elevation addressing the end of The Avenue on

the approach from Ladbroke Grove. The building in its urban context is evocative of a town hall typology, forming a focal point at a centre of the site and providing facilities for the wider community.

The second diagram illustrates the vertical order applied to the long elevation. There is a generosity of scale to the colonnade forming a base to Building 2.6 befitting of the programme. Further to this, the expressive nature of the pitched roof forms a focal point within the development. Drawing from the site's industrial heritage, the roof line creates a distinct backdrop to the newly reinstated basin, New Wharf, to the north as well as contributing to the active frontages and streetscape in the centre of the masterplan.

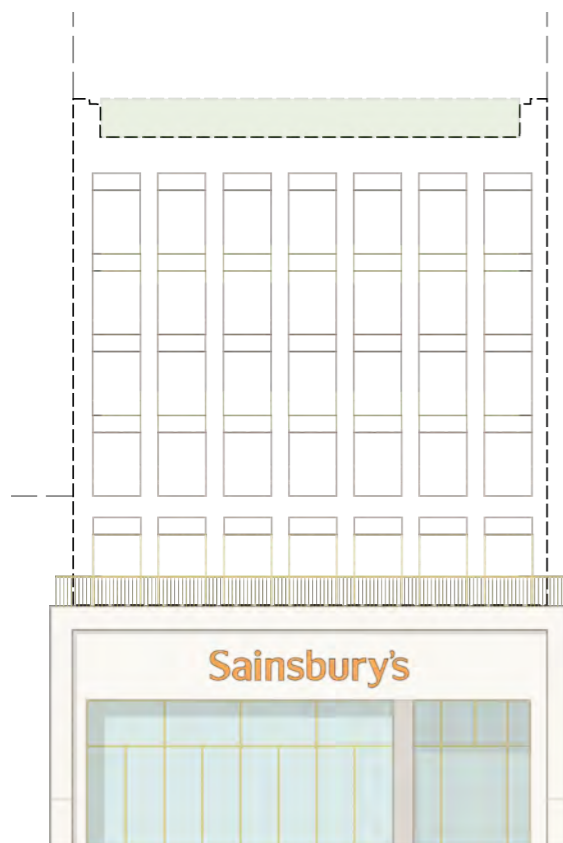

Fig 6.10: Store Entrance East Elevation Diagram

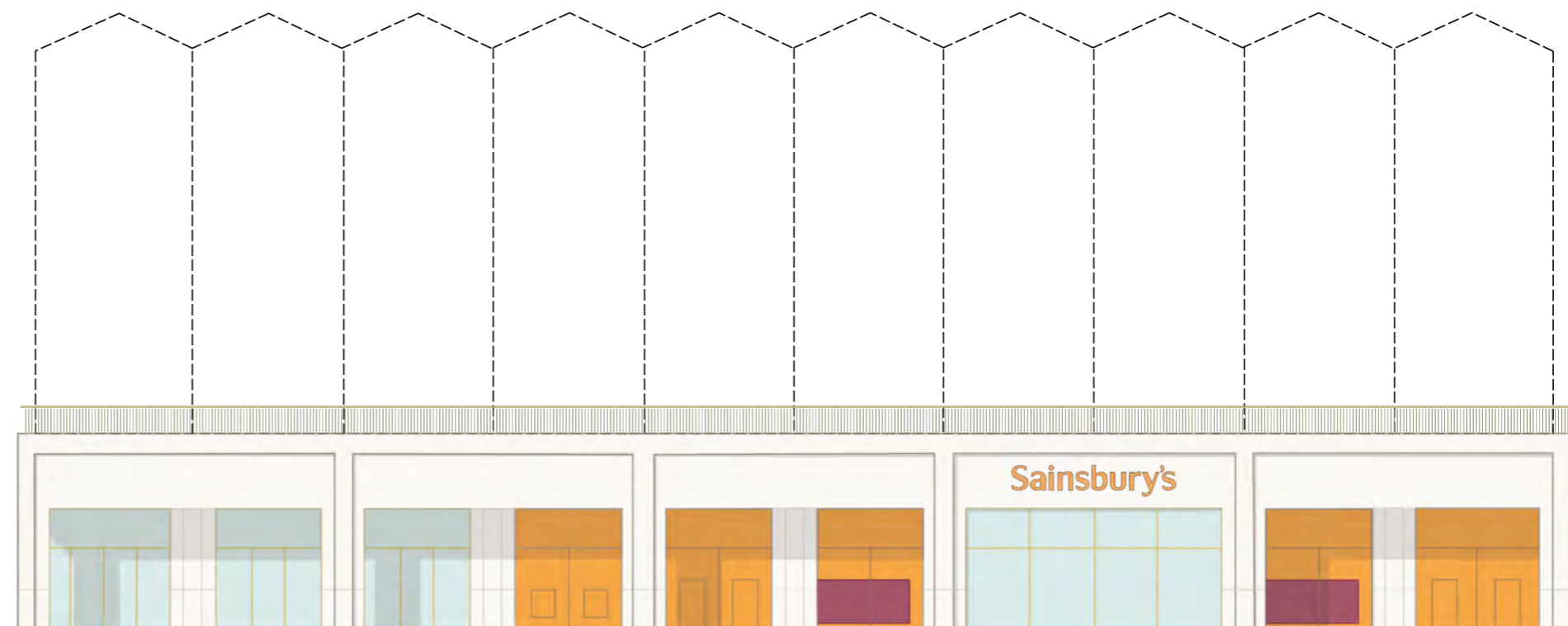

Fig 6.11: Store Entrance North Elevation Diagram